

JAN 37

THE WORLDWIDE
OF AMATEUR. SHORT WAVE.



TECHNICAL AUTHORITY
AND EXPERIMENTAL RADIO

The publishers assume no responsibility for statements made herein by contributors and correspondents, nor does publication indicate approval thereof.

No. 215

January, 1937

CONTENTS

A 10-20 Meter Push-Push 6L6 Exciter— <i>Paul D. Langrick, W6PT</i>	18
Attacking the Bias Problem— <i>Ray Dawley, W6DHG</i>	23
An Inexpensive Six-Band Transmitter— <i>B. A. Ontiveros, W6FFF</i>	26
Higher Efficiency on the Higher Frequencies— <i>Ray Dawley, W6DHG</i>	30
A \$100 Sky Wire, or QRO?	35
Connecting Condensers in Series	36
A "DB" Volume Control— <i>Leland D. Patterson</i>	39
The Cause, Effects, and Cure of Parasitics— <i>Ed. Hayes and K. V. Keeley</i>	42
F.C.C. Ratings of Common Tubes	46
Modulation Power Data	48
Calls Heard and Dx Departments	50
Open Forum	65
Looking Forward into 1937— <i>J. N. A. Hawkins, W6AAR</i>	67
The Experimental License— <i>Rufus P. Turner, W1AY</i>	70
Meet the "Mayor"	72
Simplified Operation by Means of Relays	74
A 66 Foot Vertical Dural Radiator— <i>E. H. Conklin, W9FM</i>	76
The Evolution of a Vacuum Tube— <i>W. W. Smith, W6BCX</i>	80
Radiotelephony for the Newcomer	83
Antenna Calculation Tables	86
Pentodes and Tetrodes in Ham Transmitters— <i>R. M. Purinton, W2ICU</i>	88
How Loud is Sound?	92
Low Cost C-R "Scope for the Phone Man	94
Power Supply Circuits	98
Object: More DX—Method: Less Noise— <i>C. Watzel, W2AIF, and W. Bohlen, W2CPA</i>	106
Hammanners—"Uncle Dudley"	112
The Neobeam Oscilloscope	115
An Inexpensive, Low-Power Phone-C.W. Rig— <i>Kenneth L. Kinne, W6KSX</i>	118
Wattage Input Vs. Load Impedance Chart	122
Effective B.C.L. QRM Reduction— <i>F. C. Everett</i>	124
High Voltage Cheap— <i>Charles Felstead, W6CU</i>	128
Modern Transmitter Design— <i>J. N. A. Hawkins, W6AAR</i>	131
A New and Complete Tube Table	140
Light, Inexpensive, "Multiband" Feeders— <i>J. G. Claiborne, W5FDI</i>	149
The Primary Radio Frequency Standard— <i>Rufus P. Turner, W1AY</i>	150
Monthly Radio Photo Contest	153
A Most Economical 100 Watt Phone— <i>Faust Gonsell, W6VR</i>	154
Looking Them Over	156
A Home-Made Band-Switching Receiver— <i>Melvin O. Kappler, W6LDB</i>	160
Index of Advertisers	188
"Radio" Index of 1936 Issues	189

RCA Communication Equipment



TRANSMITTING AND SPECIAL PURPOSE TUBES



Type	Amateur's Net Price	DESCRIPTION	Elec-trodes	Max. Plate Dissipation Watts	Cath-ode Type	Cath-ode Volts
203-A	\$15.00	R-F Power Amplifier, Oscillator, Class B Modulator	3	100	Filament	10.0
204-A	97.50	Oscillator, R-F Power Amplifier, Class B Modulator	3	250	Filament	11.0
211	15.00	R-F Power Amplifier, Oscillator, A-F Power Amplifier, Modulator	3	100	Filament	10.0
800	10.00	R-F Power Amplifier, Oscillator, Class B Modulator	3	35	Filament	7.5
801	4.50	R-F and A-F Power Amplifier, Oscillator, Modulator	3	20	Filament	7.5
802	3.90	R-F Power Amplifier Pentode	5	10	Heater	6.3
803	38.50	R-F Power Amplifier Pentode	5	125	Filament	10.0
804	15.00	R-F Power Amplifier Pentode	5	40	Filament	7.5
805	18.00	R-F Power Amplifier, Oscillator, Class B Modulator	3	125	Filament	10.0
807	3.90	Transmitting Beam-Power Amplifier	4	21	Heater	6.3
808	10.00	R-F Power Amplifier, Oscillator, Class B Modulator	3	50	Filament	7.5
830-B	10.00	Class B Modulator, R-F Power Amplifier, Oscillator	3	60	Filament	10.0
831	265.00	Oscillator, R-F Power Amplifier	3	400	Filament	11.0
834	12.50	R-F Power Amplifier and Oscillator	3	50	Filament	7.5
837	8.50	R-F Power Amplifier Pentode	5	12	Heater	12.6
838	16.00	Class B Modulator, R-F Power Amplifier, Oscillator	3	100	Filament	10.0
840	6.00	R-F Pentode	5	—	Filament	2.0
841	3.25	R-F Power Amplifier, Oscillator A-F Voltage Amplifier	3	15	Filament	7.5
842	3.25	A-F Power Amplifier, Modulator	3	12	Filament	7.5
843	12.50	Power Amplifier, Oscillator	3	15	Heater	2.5
844	18.00	Screen-Grid R-F Power Amplifier	4	15	Heater	2.5
845	16.00	Modulator, A-F Power Amplifier	3	75	Filament	10.0
849	160.00	Modulator, A-F Power Amplifier, R-F Power Amplifier, Oscillator	3	400	Filament	11.0
850	37.50	Screen-Grid R-F Power Amplifier	4	100	Filament	10.0
851	350.00	Modulator, A-F Power Amplifier, R-F Power Amplifier, Oscillator	3	750	Filament	11.0
852	16.40	Oscillator, R-F Power Amplifier	3	100	Filament	10.0
860	32.50	Screen-Grid R-F Power Amplifier	4	100	Filament	10.0
861	295.00	Screen-Grid R-F Power Amplifier	4	400	Filament	11.0
864	1.60	Amplifier (Low Microphonic Design)	3	—	Filament	1.1
865	12.75	Screen-Grid R-F Power Amplifier	4	15	Filament	7.5
868	5.00	Phototube	2	—	—	—
917	6.00	Phototube (High-Vacuum Type)	2	—	—	—
918	5.00	Phototube (High Sensitivity)	2	—	—	—
919	6.00	Phototube (High-Vacuum Type)	2	—	—	—
920	7.00	Twin Phototube	4	—	—	—
954	5.80	Detector, Amplifier Pentode (Acorn Type)	5	—	Heater	6.3
955	3.75	Amplifier, Detector, Oscillator (Acorn Type)	3	—	Heater	6.3
956	5.80	Super-Control R-F Pentode (Acorn Type)	5	—	Heater	6.3
991	.90	Voltage Regulator	2	—	—	—
1602	2.75	Amplifier Triode (Low-Microphonic Type)	3	15	Filament	7.5
1603	2.25	Amplifier Pentode (Low-Microphonic Type)	5	—	Heater	6.3

Type	Amateur's Net Price	RECTIFIERS	Elec-trodes	Max. Peak Inverse Volts	Cath-ode Type	Cath-ode Volts
217-A	\$20.00	Half-Wave, High-Vacuum	2	3,500	Filament	10.0
217-C	20.00	Half-Wave, High-Vacuum	2	7,500	Filament	10.0
836	11.50	Half-Wave, High-Vacuum	2	5,000	Heater	2.5
866	1.75	Half-Wave, Mercury-Vapor	2	7,500	Filament	2.5
866-A	4.00	Half-Wave, Mercury-Vapor	2	10,000	Filament	2.5
872	14.00	Half-Wave, Mercury-Vapor	2	7,500	Filament	5.0
872-A	16.50	Half-Wave, Mercury-Vapor	2	10,000	Filament	5.0
878	11.00	Half-Wave, High-Vacuum for Cathode-Ray Tubes	2	20,000	Filament	2.5
879	3.00	Half-Wave, High-Vacuum for Cathode-Ray Tubes	2	7,500	Filament	2.5
885	2.00	Gas-Triode for Cathode-Ray Sweep-Circuit Control	3	300	Heater	2.5

Type	Amateur's Net Price	HIGH-VACUUM CATHODE-RAY TUBES	Elec-trodes	Max. Anode No. 2 Volts	Cath-ode Type	Cath-ode Volts
903	\$97.50	9 in., Electromagnetic Deflection, High-Vacuum	5	7,000	Heater	2.5
904	52.50	5 in., Electrostatic-Magnetic Deflection, High-Vacuum	5	4,600	Heater	2.5
905	45.00	5 in., Electrostatic Deflection, High-Vacuum	4	2,000	Heater	2.5
906	18.00	3 in., Electrostatic Deflection, High-Vacuum	4	1,200	Heater	2.5
907	48.75	5 in., Electrostatic Deflection, High-Vacuum, Short Persistence Screen	4	2,000	Heater	2.5
908	21.00	3 in., Electrostatic Deflection, High-Vacuum, Short Persistence Screen	4	1,200	Heater	2.5
909	49.00	5 in., Electrostatic Deflection, High-Vacuum, Long Persistence Screen	4	2,000	Heater	2.5
910	21.25	3 in., Electrostatic Deflection, High-Vacuum, Long Persistence Screen	4	1,200	Heater	2.5
911	22.50	3 in., Electrostatic Deflection, High-Vacuum, Electron gun of low-magnetic material	4	1,200	Heater	2.5
912	163.40	5 in., Electrostatic Deflection, High-Voltage, High-Vacuum	4	15,000	Heater	2.5
913	5.60	1 in., Electrostatic Deflection, Low-Voltage	4	500	Heater	6.3

Prices effective Nov. 16, 1936. Prices subject to change or withdrawal without notice.



RCA Manufacturing Co., Inc.
Camden, N. J.



For

... HIGH QUALITY ... LOW PRICE



ACT-40



ACT-200

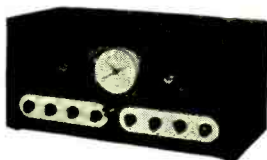

ACR-175

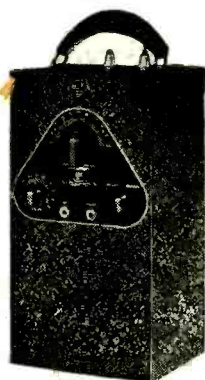

ATR-219

The ACT-40 Transmitter is nominally rated at 40 watts output on either 'phone or c.w. The r-f system employs an RCA-47 as a crystal oscillator, an RCA-802 as a buffer or doubler and two RCA-801's as final amplifiers. Coils are available for the 20, 40, 80 and 160 meter amateur bands. The a-f system employs two RCA-57's as speech amplifiers, 2 RCA-45's as drivers and 2 RCA-801's as Class "B" Modulators. Individual units of the ACT-40 may be purchased separately. The price complete for 'phone operation with one set of coils but less tubes, crystals, microphone, key and other accessories is \$235.00.

The ACT-200 Transmitter is nominally rated at 200 watts output on 'phone and 260 watts output on c.w. The r-f system employs the r-f unit used in the ACT-40 to drive 2 RCA-838's in the power amplifier. The a-f system consists of a separate speech amplifier unit which mounts on the operating table, driver stages mounted in the transmitter proper, and 2 RCA-838's as Class "B" Modulators. Individual units of the ACT-200 may be purchased separately. Coils are available for 20, 40, 80 and 160 meter bands. Amateur's net price for ACT-200 with one set of coils but less tubes, crystals, microphone, key and other accessories, \$475.00.

The ACR-175 Receiver is an 11 tube superheterodyne covering from 500 to 60,000 kilocycles. Incorporating such advanced design features as magnetite-core i-f transformers, crystal filter, electron-ray tuning and signal-input measuring tube, two i-f stages, a.v.c., band-change switch, single-control tuning, this receiver is ideally suited for communication requirements. The amateur's net price complete with tubes, speaker and power supply is \$119.50.

The ATR-219 Transceiver is designed for operation by licensed amateurs in the five meter band. For transmitting, an RCA-19 is employed as a unity-coupled oscillator, another RCA-19 as a Class "B" Modulator and an RCA-30 as a speech amplifier. For receiving, one RCA-19 is used as a super-regenerative detector, the RCA-30 as an a-f amplifier, and the other RCA-19 as a Class "B" audio-output tube. Space is provided in the cabinet for batteries. The amateur's net price, less tubes, batteries, headphones, microphone, etc., is \$19.95.

Note: All prices are f.o.b. Factory and are subject to change or withdrawal without notice. For additional information on products listed or information on other RCA products, write to Amateur Radio Section, RCA Manufacturing Company, Inc., Camden, New Jersey.

Amateur Radio



AMATEUR EQUIPMENT



PRECISION

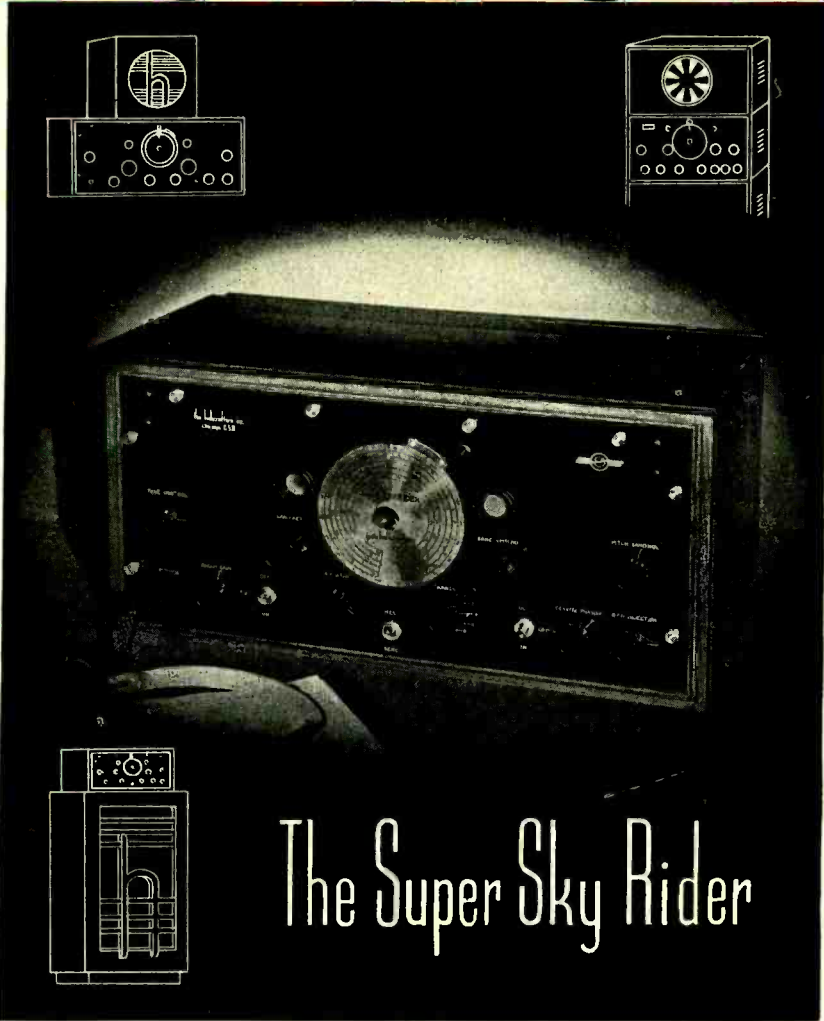

The Super Sky Rider

PRECISION — the one word above all others that most eloquently describes the construction of a communications receiver.

Precision is engineering design — in the exacting specifications of every component part — in every step of assembly — in the specially built test equipment, so precise, so accurate, that its use is limited to only the most sensitive and selective of receivers.

Precision permeates every thought of the designer of a communications receiver — every action of the builder.

In such a spirit, to such ideals, Hallicrafters Receivers are conceived and built.

A Solid Walnut Copper-lined cabinet with speaker cabinets of individual and console types to match, are now available for the Super Sky Rider.

ALL
HALLICRAFTERS
RECEIVERS
Now Available on
TIME PAYMENTS
through your jobber

the hallicrafters inc.

2609 Indiana Ave.
Chicago, Ill. U.S.A.

The ULTRA SKY-RIDER



Designed for Better
ULTRA HIGH FREQUENCY
RECEPTION

TUNES FROM 3.76 TO 53 METERS

FEATURES

- No Plug-in Coils.
- Individual Coils for each band.
- 10 All-Metal Tubes.
- Generous Isolantite and Steatite Insulator.
- Continuous Electro-Mechanical Band Spread.
- Iron Core Expanding I. F. Transformer.
- Built-in Power Pack.
- Frequency Calibrated Micro-Vernier 4-Band Dial.
- Antenna Compensator.
- Moderate Price.

The Ultra High Frequency fans are singing the praises of this finest of Hallicrafters receivers, the only one of its kind available today.

Unquestionably one of the most advanced communications receivers of the year, it is setting new standards of performance everywhere.

The Ultra Sky Rider is a new and unique approach to Ultra Frequency Reception with dozens of exclusive engineering and construction features. It fulfills the amateur's dream for 5-10 meter reception — and tunes up to 46 meters with the same high efficiency. The built-in Lamb Noise Silencer eliminates most of the man-made noises usually so prevalent with high frequency reception.

Write today for complete details of this sensational receiver!

TIME PAYMENTS

All Hallicrafters Receivers are now available on Time Payments. Enjoy the superior reception of these marvelous receivers while you are paying for them. Write for full information on the Hallicrafters Time Payment Plan.

The SUPER SKY RIDER

A MODERN COMMUNICATIONS RECEIVER

Now Available on Time Payments!



It doesn't seem possible but it's true! The New 1937 Super Sky Rider is better than ever before. With Eleven Tubes, Selectivity beyond last year's model, Greater Sensitivity and a new high fidelity power output (17 watts max.) this new receiver has reached greater heights in performance. Many new features add to its efficiency and convenience in operation. Now the Super Sky Rider is more than ever before the "perfect" receiver for the amateur.

NOW AVAILABLE ON TIME PAYMENTS

- ★ 11 Tubes — 10 of them metal.
- ★ 40 M. C. to 535 K. C. in 5 Bands.
- ★ 338 degree main tuning dial.
- ★ Electro-Mechanical Band Spread.
- ★ Direct Calibration Tuning—No Charts or Tables.
- ★ 14 Watts Undistorted Output.
- ★ Field Strength Indicator.
- ★ Improved 10 meter performance.
- ★ Single Signal Crystal Action.
- ★ 464 K. C. Iron Core I. F. for improved selectivity.
- ★ Ceramic Insulation.

DAVEGA

RADIO COMPANY

63 CORTLAND STREET, NEW YORK CITY, N. Y.

MAIL THIS COUPON!

The RADIO SHACK

46 BRATTLE STREET • BOSTON, MASS.

PLEASE SEND ME COMPLETE DETAILS ON THE NEW ULTRA SKY RIDER.

NAME CALL

ADDRESS

CITY STATE

MAIL THIS COUPON

DAVEGA RADIO COMPANY,
63 Cortland St., New York City, N. Y.

Please send me complete information on the New Super Sky Rider.

Name Call

Address

City State

the SKY RIDER COMMERCIAL

A
NEW
HALLICRAFTERS
ENGINEERED
"PROFESSIONAL"
Communications
RECEIVER



SEE this "professional" type communications receiver, an outstanding new development of the famous Hallicrafters laboratories. With a tuning range from 10.25 M. C. to 100 K. C., this set covers the long wave bands up to 3000 Meters and down to 29.25 meters.

Embodied in the Sky Rider Commercial are all the sensational features found on the Hallicrafters Super Sky Rider that have made it so outstanding in the amateur radio field.

An eleven tube superheterodyne equipped with All-Metal Tubes, Field Strength Indicator, 5 Band Illuminated and Direct Calibrated Dial (No Charts or Tables required), Electrical Band Spread, 2 Stages of Iron Core I. F. for finer sensitivity, greater selectivity and better signal to noise ratio, this receiver is a real contribution to the amateur radio art. With the Ultra Sky Rider it provides complete coverage of the Radio spectrum.

FEATURES

- Micro-Vernier Band Spread.
- Direct Calibration Tuning —No Charts or Tables.
- 1600 K. C. Iron Core I. F. System.
- 338 Degree Dial.
- 14 Watts Undistorted Output.
- Field Strength Indicator.
- All Metal Tubes.
- Illuminated Band Spread and Main Tuning Dial.

MAKE HARVEY'S YOUR SOURCE OF SUPPLY FOR AMATEUR RADIO EQUIPMENT

HEADQUARTERS FOR
HALLICRAFTERS RECEIVERS

Owned and operated by amateurs, Harvey Radio Company can give you the kind of personalized technical service the amateur requires.

Let us supply your needs in amateur equipment.

HARVEY RADIO COMPANY

103 WEST 43RD STREET, NEW YORK CITY, N. Y.

ALL HALLICRAFTER
RECEIVERS NOW
AVAILABLE ON
EASY TIME
PAYMENTS

Please send me complete information on the New Sky Rider Commercial.

NAME.....

ADDRESS.....

CITY..... STATE.....

W 2 1 J L

W 2 1 J L

THE Sky Chief

PRECISION-BUILT

A 7-TUBE Hallicrafters COMMUNICATIONS RECEIVER

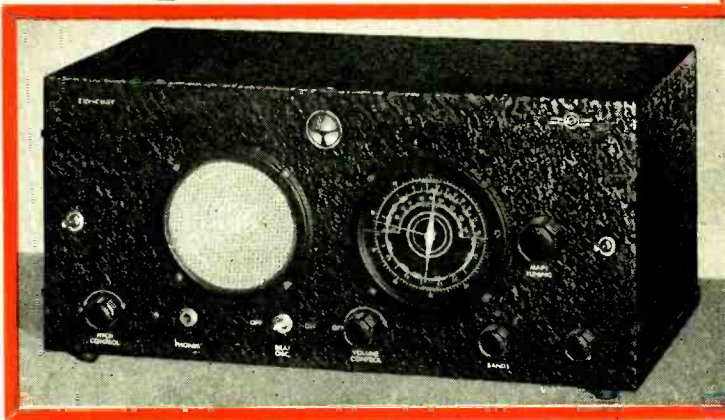

**OUTSTANDING PERFORMANCE At An
EXCEPTIONALLY LOW PRICE**

HINDS & EDGARTON SERVICE

This organization of amateurs is exclusively a receiver and transmitter house, not a parts jobber, and offers the kind of specialized and experienced service seldom available elsewhere.

Because of our Chicago location we are in excellent position to render complete and speedy service on Hallicrafters receivers, and in close touch with the latest developments in the famous Hallicrafters line.

Send the coupon today for Free Hinds and Edgerton Catalog containing full details on all Hallicrafters Receivers.

TIME PAYMENTS

Purchase your new Hallicrafters receiver on Hinds and Edgerton Time Payment Plan—small down payments and easy monthly terms. Write for complete details.

The Sky Chief provides all the features and special controls so desirable to the critical operator, exceptionally fine sensitivity—selectivity and splendid performance at an especially attractive price that makes it one of the outstanding values in amateur radio. With a frequency range from 17.6 M. C. to 540 K. C., a direct calibrated 3-band illuminated dial, Mechanical Band Spread, Built-in Power Pack and Speaker, the Sky Chief is one of the most convenient and efficient receivers any amateur could own. Its performance is equal to that of many higher priced receivers. Get full details on the Sky Chief today. Mail the coupon at once!

ALL THE FEATURES OF HIGHER PRICED RECEIVERS

- Single Stage 465 K.C. Iron Core I. F.
- 17.6 to 540 K.C. in 3 Bands.
- Variable Beat Oscillator.
- Mechanical Band Spread.
- Automatic Volume Control.
- Built-in Speaker and Power Pack.

HINDS & EDGARTON

ESTABLISHED 1914
19 SOUTH WELLS STREET • CHICAGO, ILLINOIS

Gentlemen: Please send complete details of the New 1937 Sky Chief and Hinds and Edgerton Time Payment Plan.

NAME _____ CALL _____

ADDRESS _____

CITY _____ STATE _____

OPERATED BY W9APY AND W9WR

THE Sky Buddy

A GENUINE Quality-Built
 HALLICRAFTERS -
 ENGINEERED Junior
 Communications Receiver at
 an AMAZINGLY Low Price!



THE GREATEST VALUE IN AMATEUR RADIO TODAY!

\$29⁵⁰
 Cash Price

● With many of the features and the performance of more expensive receivers, the Sky Buddy is the ideal receiver for the beginner and short wave listener. It's Hallicrafters-engineered, a 5-Tube Superheterodyne with 8-Tube performance, — the perfect receiver for the beginner in amateur radio and short wave listeners.

The Sky Buddy tunes from 18 to 555 Meters (16.5 M.C. to 544 K.C.) on an illuminated 3-Band Direct-Calibrated Dial. With a 36 to 1 Band Spread and marvelous selectivity, you can easily separate stations on the crowded amateur bands.

The Sky Buddy has all the convenience of a broadcast receiver, yet it gives you the performance of much higher priced communications receivers. No cumbersome plug-in coils, instead a simple 3-way Band Switch. Beat Oscillator Switch, Pitch control, Phone Jack — all the essentials are there for communications reception.

Write for complete information today!

ALL HALLICRAFTERS RECEIVERS NOW AVAILABLE ON TIME PAYMENTS

the hallicrafters inc.
 2613 INDIANA AVENUE
 CHICAGO, ILLINOIS, U. S. A.

*America's Leading Manufacturers of
 Communications Receivers*

OUTSTANDING FEATURES OF THE SKY BUDDY

- 18 to 555 Meters in 3 Bands.
- 5 Tubes do the work of 8.
- Combined I.F. and Beat Frequency Oscillator.
- Built-in Speaker and Power Supply.
- Single Tuning Control.
- Iron Core I.F. (High Gain and Selectivity.)
- Mechanical Band Spread.
- Beat Frequency Oscillator.

MAIL THIS COUPON

The Hallicrafters, Inc.
 2613 Indiana Avenue
 Chicago, Illinois

Please send me complete information on the
 Hallicrafters Sky Buddy.

Name Call

Address

City State

We Recommend the NEW 1937 SUPER SKY RIDER

AMERICA'S Most POPULAR Communication Receiver



TRI-STATE'S Twenty-Four Years of Radio Experience Assures Satisfactory Service

For the kind of personal attention you need, come to Tri-State. We carry a complete line of Short Wave Receivers, Test Equipment, and Public Address Equipment of unsurpassed quality. Tri-State is owned and operated by amateurs.

*Write today for the
Tri-State Catalog.*

MOST FAVORABLE TIME PAYMENT TERMS AVAILABLE ANYWHERE

All Tri-State Equipment is available on sensationally low time payment terms with total finance charges as little as 3% on the unpaid balance. 10% down payment and 10 months to pay. It pays to deal with Tri-State.

TRI-STATE RADIO EQUIPMENT CO.

403 PENN AVE., PITTSBURGH, PA.

W8FQ - W8MYM

OPERATED FOR AMATEURS
BY AMATEURS

We can sincerely endorse and recommend the New Super Sky Rider to every amateur radio operator as one of the most outstanding communications receivers of the year. This eleven tube superheterodyne has everything the most critical amateur could wish for.

The highest degree of sensitivity and selectivity—a direct-calibrated 338° Micro-Vernier 5-Band Dial, no charts or tables required—Field Strength Indicator—Specially Designed Iron Core I.F. for finer sensitivity—better selectivity and improved signal to noise ratio—the latest type All Metal Tubes—these are just a few of the outstanding features of this remarkable modern receiver.

See the Super Sky Rider at our store today, or write for full particulars.

OUTSTANDING FEATURES

- 11 Tubes, 10 of them metal.
- 40 M. C. to 535 K. C. in 5 bands.
- 338 Degrees main tuning dial.
- 14 Watts Undistorted Output.
- Direct Calibration Tuning—No Charts or Tables.
- Field Strength Indicator.
- Improved 10 meter performance.
- 465 K. C. Iron Core I. F. for improved selectivity.

MAIL THIS COUPON!

TRI-STATE RADIO EQUIPMENT CO.
403 PENN AVE., PITTSBURGH, PA.

*Please send me complete details on Super Sky Rider and
Tri-State Catalog.*

NAME _____ CALL _____
ADDRESS _____
CITY _____ STATE _____



Phone: YOrk 7226
Published by Radio, Ltd.

RADIO

7460 BEVERLY BOULEVARD
LOS ANGELES

Cable address:
Radiopubs, Los Angeles

New York Office:
17 East 42d Street
Phone: MUrray Hill 2-5973

Direct all correspondence to the home office at
Los Angeles except as otherwise requested.

Chicago Office:
3618 No. Bernard Street
Phone: JUNiper 5575

Rates and Notices

Single Copy Rates

(except for special issues)

On newsstands:

30c in U.S.A. and Canada
1/8 in the United Kingdom
2/- in Australia and New Zealand

By mail, postpaid from home office:

Current issue:

30c in U.S.A., Canada, Newfoundland,
Cuba, and Mexico
35c in countries which take the \$3.00
subscription rate
40c elsewhere.

Back issue (if available):

35c in U.S.A.; 40c elsewhere.

Subscription Rates

	1 Year†	2 Year†
U.S.A.* (and possessions), Canada, Newfoundland, Cuba, and Mexico.	\$2.50*	\$4.00*
Andorra, Argentina, Bolivia, Brazil, Chile, Colombia, Costa Rica, Do- minican Republic, Ecuador, Guate- mala, Haiti, Honduras, Nicaragua, Panama, Paraguay, Peru, Salva- dor, Spain (and possessions), Uru- guay, and Venezuela	\$3.00	\$5.00
United Kingdom	14/6	24/6
Elsewhere	\$3.50	\$6.00

*In California, add 3% sales tax

Duties, if any, are not included in above rates.

†FREQUENCY

Published monthly (in the month preceding its cover date) except for August and September; ten issues yearly including enlarged special annual number. Special numbers will not be included with subscriptions for less than five issues; subscriptions cannot be started with back issues.

Terms and Remittances

Remittance in full must accompany all orders and must be payable *at par* in continental U.S.A., Canada, or the United Kingdom; British and Canadian postal notes accepted. Currency, etc. is at sender's risk. No stamps, please, unless other means of remittance are not available.

IF YOU MOVE

notify us *in advance* (first week of month preceding cover date); we cannot duplicate copies already sent to your old address; under U.S. postal laws these will be *destroyed* unless you have left forwarding postage with the postmaster (usually 6c per copy in U.S.A.)

DISTRIBUTION IN BULK

In the continental U.S.A. (except New York and Chicago), Hawaii, and Canada, RADIO is distributed to the trade through dealers associated with the Kable News Co., Mt. Morris, Ill., to whom inquiries should be sent. In New York and Chicago, consult our local office. In U.S. territories (except Hawaii) and in foreign countries the trade is supplied direct from our home office at Los Angeles.

PRINCIPAL FOREIGN AGENTS

Canada: J. A. Holmes, 615 W. Hastings St., Vancouver.

Europe: N. E. Read, 37, Willow Street, Oswestry, Shropshire, England.

Australasia: "The Bulletin," Box 2521BB, Sydney. McGills, 183 Elizabeth St., Melbourne. Swain & Co., Ltd., Pitts St., Sydney.

Te Aro, 94 Courtenay Place, Wellington.

South America: F. Stark, Caixa 2786, Sao Paulo. *Revista Grafica*, Peru 166, Buenos Aires

The Staff

Technical and Editorial Department

Editor

W. W. SMITH, W6BCX

Engineering Editors

ROBERT S. KRUSE,¹ W1FG

J. N. A. HAWKINS, W6AAR

Associate Editors

K. V. R. LANSINGH, W6QX

B. A. ONTIVEROS, W6FFF

Assistant Editors

HERBERT BECKER, W6QD

GEORGE D. WALKER,² W4CTO

E. H. CONKLIN,⁴ W9FM

CHARLES A. HILL, W6BRO

RUFUS P. TURNER,³ W1AY

Technical Consultants

RALPH O. GORDON, W6CLH

JAMES M. SHARP, JR., W6DMY

CHARLES D. PERRINE, JR., W6CUH

Laboratorian

RAYMOND DAWLEY, W6DHG

Laboratory Assistants

FAUST GONSETT, W6VR

MARTIN A. BROWN, W6ABF

JACK HARWOOD, W6DJZ

Technical Draftsmen

M. S. DAVIS

WILLIAM ROBERTS, W3BOI

Editorial Secretary

D. O. WORTHINGTON

Business Department

Los Angeles

Publisher

K. V. R. LANSINGH

Managing Editor

M. M. LLOYD

Circulation Manager

B. L. HOVER

New York

Eastern Advertising Manager

CLARENCE W. EMERSON

Eastern General Manager

V. R. LANSINGH

New York Circulation Representative

EDWARD J. BYRNE

Chicago

Midwestern Advertising Manager

CLYDE W. NELSON

Correspondence and Manuscripts

Address all correspondence and manuscripts to the home office at Los Angeles except as follows:

1. *Radiodivities, Strays*, and the like may be sent to Rufus P. Turner.³
2. Calls Heard may be sent to George Walker²; also dx news and station descriptions from eastern America and from transatlantic countries.
3. Advertising inquiries may be directed to our nearest office, but all copy and cuts should be sent direct to Los Angeles.

Unusable, unsolicited manuscripts will be destroyed unless accompanied by a stamped, addressed envelope.

Copyright, 1936, RADIO, Ltd. All rights reserved. Reproduction without permission is forbidden; permission is usually granted amateur radio papers on request.

Printed in U.S.A. by
GLENDALE PRINTERS, GLENDALE, CALIFORNIA

¹Box 115, Guilford, Connecticut.

²Box 355, Winsron-Salem, North Carolina.

³159 W. Springfield Street, Boston, Massachusetts.

⁴112 N. Main St., Wheaton, Illinois.

Taylor Tubes Win!

HELLO
PALS!

MEET THE NEW
AMATEURS CHAMP.
KID-TAYLOR TUBES
HE HAS MORE SOCK
THAN ANY OTHER
TUBE BATTLER IN
THE AMATEUR
BANDS.

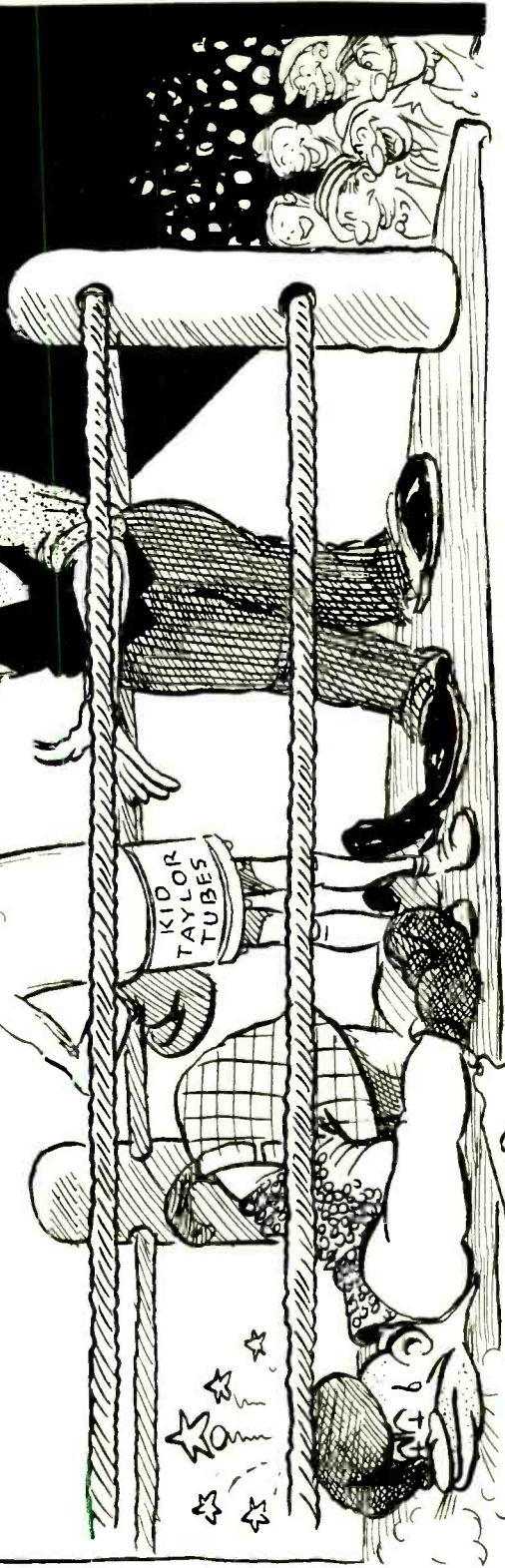

The Taylor Combined Catalog and Handbook—Free—tells you how to lick Ol' Man Q R M in one easy lesson. Send for it or get it at your favorite Distributor!

TAYLOR TUBES, INC. 2341-B Wabansia Avenue, Chicago, Illinois

"More Watts Per Dollar"

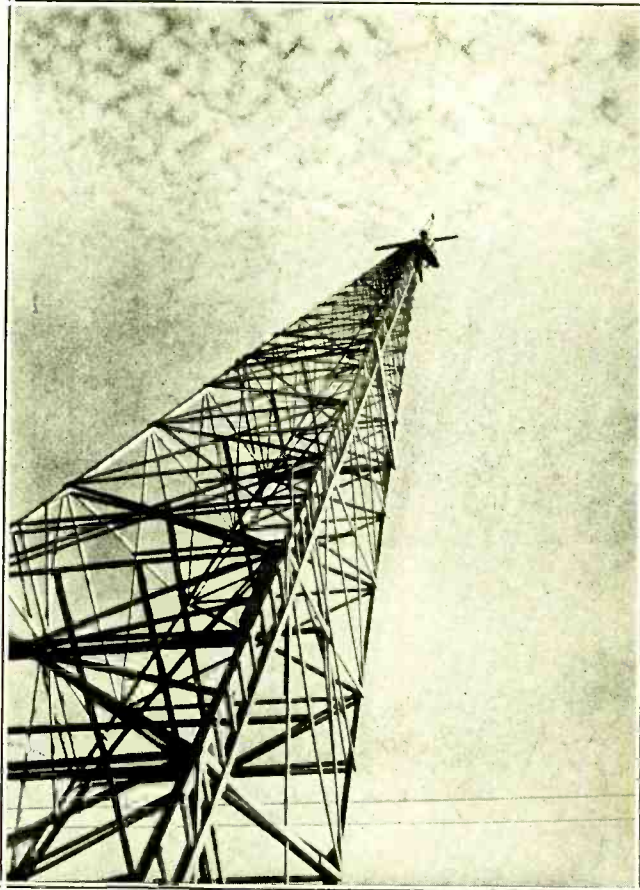

The 95 foot guyless tower of W6FNE, using the type construction described in "Radio" by W6DDS.



RADIO
with the
EDITORS

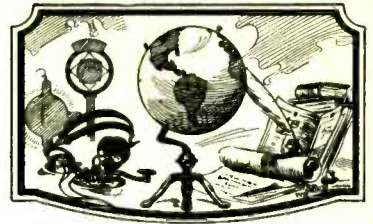

First

The editors have long dreamed of a special annual issue of RADIO which would occupy the same place in the field of amateur radio that various well-known trade annuals occupy in their respective fields.

Our first attempt is presented herewith, perhaps with a pardonable bit of pride, though it is far from being what we had hoped to make it.

Our readers will confer a great favor upon us if they will jot down and mail us specific suggestions for improvement. We want to make next year's issue as near to your idea of the ultimate in amateur radio magazines as is humanly possible, but we need your help; we are hams ourselves, but not mind-readers, and cannot be sure that our ideas will conform with those of a majority of our readers.

One section which we had hoped to include is conspicuous by its absence. This was to contain among other items reviews of technical progress of the past year, and pre-announcements from a number of manufacturers of developments of importance (from the amateur standpoint) which were soon to be released from their laboratories or production lines. We bespeak the cooperation of our readers who work with such companies, so that announcements next year which are to "break" in the midwinter will, when possible, be so scheduled as to enable their appearance in this issue. Such a policy will, we believe, be for the benefit of all concerned—reader, manufacturer, and magazine.

We desire particularly to thank the advertisers whose increased space in this issue has helped to make its production possible.

High Power Vs. Low Power

In the pages of our own "Open Forum" section, in our largest strictly amateur contemporary, and in the lesser amateur press, the argument on high power versus low power continues unabated. While willing to let arguments on both sides "see the light of day", it is our humble belief that the adjustment of any particular transmitter is of much greater importance than the amount of power being used. We will not forget in a hurry the terrific interference caused in Los Angeles some time ago by a so-called "five-watter" which for months

simply blotted out the "California kilowatts" in our backyards.

It is interference of which we wish to be rid, and power is but one of the possible causes.

We cannot leave this subject without mentioning one factor which we believe to be of great importance and which seems to have been lost sight of in the arguments so far put forth which are based almost solely on the technical aspects of the matter. We should remember that amateur radio has lost all too many of its rights and frequencies in a steady stream in the past decade. This magazine as loudly as possible and another in a somewhat softer vein have attempted to notify the world that we will stand for no more encroachments, and that we demand the return of at least a portion of what is rightfully ours: by priority, by citizenship, by right of numbers, and by right of public service rendered.

What likelihood is there that the radio world in general will believe we "mean business" if we follow up such pronouncements by advocating that still more be taken away from us: nine-tenths, say, of our allowed power?

Middle of the Road

We are really tired of repeating it, but it seems necessary. The editorials of this magazine (since it was taken over by the present staff) which have criticized Secretary-General Manager-Editor Warner do not mean that we advocate his removal entirely from the Headquarters of the American Radio Relay League.

Mr. Warner's present position includes what would normally be considered the work of three men: the editing of *QST*, the general-management of the League and its headquarters' staff, and control and active participation in the League's contacts with the outside radio world—its "political" affairs. We merely advocate that this work be split among three men; that Mr. Warner retain that portion for which he is best fitted, surrendering those portions at which he has been least successful.

Much has been made of the matter of Mr. Warner's salary. We consider this to be of decidedly secondary importance, though admitting that his present figure would seem a bit high after his jobs have been separated and reduced—for an organization of the League's moderate size and income.



A 10-20 Meter, Push-Push 6L6 Exciter

By PAUL D. LANGRICK*, W6PT, W6XFL

Perhaps you too have been troubled in getting that 10 meter transmitter to

function properly. I have received several calls recently from friends who are apparently having great difficulty in getting any power output on 10 meters. When I inquire as to the tube line-up, it usually starts out with something like this: A 53 or a 6A6 as perhaps a crystal oscil-

For those who have had trouble getting 10 meter excitation we offer this exciter as a sure-fire combination. It provides approximately 20 watts output on 10 or 20 meters, using low voltage and inexpensive tubes. It is used by the author to drive a pair of 210's to very high efficiency on 10 and 20 meters, which in turn drive a pair of HF-200's.

was announced at that time, and W6CLH devised a push-push circuit which was one of

the most efficient doubler circuits that either of us had used up to the time. The only apparent disadvantage of this circuit was the fact that it took considerable power to drive it. The usual tube line-up with this circuit was a 47 crystal oscillator followed by a 46 doubling from 80 to 40 meters, a second doubler consisting of a 46 in a highly-regenerative type doubler circuit doubling from 40 to 20 meters. The grid current on the 2A5's running from 15 to 20 ma. would drive the neutralized 210's on 10 meters to from 120 to 150 watts input, this with 800 volts on the plates of the 210's. As mentioned previously, up to this time this was the most efficient doubler circuit that we had used, but required high drive for high efficiency.

When the small transmitting pentodes (802 and the RK23 and 25's) were brought out, it was found that a single one of these tubes would put out as much power on 10 meters as the push-push 2A5's (with 600 volts on the plate of the 802 and about 400 to 425 volts on the plates of the 2A5's). On account of its inherent characteristics it was much easier to drive the single 802 doubler. Of course, the push-push circuit was discarded in favor of the pentode-type tube as a doubler from 20 to 10 meters.

About eighteen months ago it was necessary for the author to build a transmitter with a minimum number of stages to operate on the experimental frequencies lying between 5 and 10 meters. We were limited to two power supplies, one operating at approximately 400 volts d.c., and the other operating between 550 and 600 volts d.c. Therefore, it was necessary to do some experimental work to find the proper circuits to give at least a respectable amount of efficiency at these frequencies, as it is well known that the losses in any circuit used between 5 and 10 meters are extremely high.

We recalled the old circuit using 2A5's or 42's in the push-push type circuit. The author could not understand why it took so much

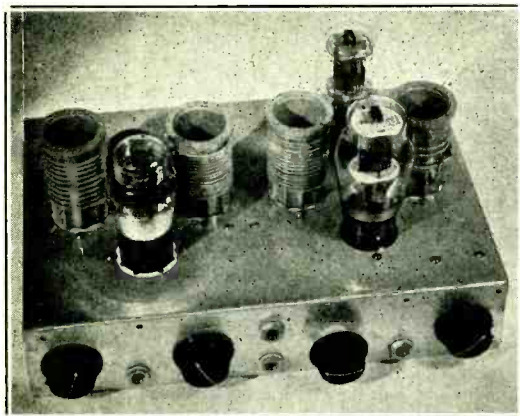

Looking Down on the Exciter from the Front

lator and doubler or as a push-pull oscillator with either 2 or 3 push-push stages, using the same type tubes. This brings back to my mind the trouble that I encountered in getting a crystal controlled transmitter to operate on 10 meters about three years ago. At that time the 59 type tube was supposed to be the last word as a doubler. Upon investigation it was found that the tube worked very well doubling from 40 to 20 meters but it was another story when one attempted to double from 20 to 10 meters. The circuit losses were so high that it was impossible to obtain any efficiency.

Ralph Gordon, W6CLH, and myself were the only ones at that time in Los Angeles who were operating 10 meter crystal-controlled transmitters. We both experienced this difficulty in obtaining any power output in doubling from 20 to 10 meters. The type 2A5 tube

*626 Maltman Ave., Los Angeles, Calif.

power to drive these tubes; so therefore an experimental set-up was devised, incorporating this circuit, and extensive measurements were made to determine the amount of drive necessary to make these tubes work efficiently, and to have a respectable amount of power output in this circuit. It was found that instead of 15 to 20 ma. grid current as previously used that it was possible with a minimum of approximately 5 to 6 ma. to obtain *almost* as much power output (within 2 or 3 watts) as that obtained with the higher amount of grid drive. Therefore, a 53 type tube was used as a combination crystal oscillator and doubler driving the 2A5 push-push tubes. The efficiency was good, even if not as high as could be obtained with more drive.

With 24 to 25 watts input, it was possible to obtain approximately 15 watts output, which was sufficient to drive the following stage. On certain frequencies the efficiency of the circuit has been as high as 75%, which is extremely good efficiency in a neutralized stage, let alone in a doubler.

With the advent of the type 6L6 tubes it was realized that we now had tubes that would be easy to drive, and at the same time obtain high efficiency and high-power output. Both the metal and glass type 6L6 tubes were used, and worked well. It was found when using the

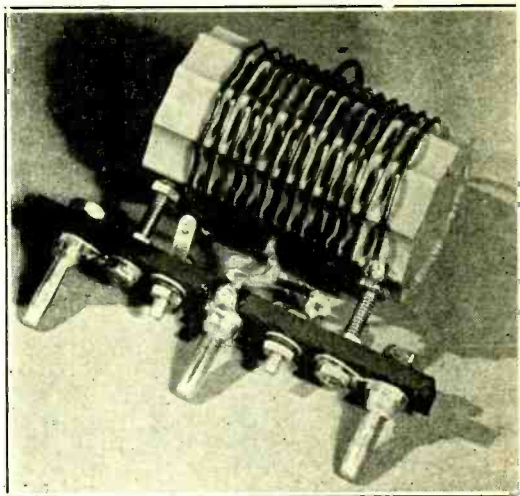

For the plate tank of the 210 stage, the bases of the plug-in coils are sawed off and the coils mounted as shown here. The losses are lower and the coil is more symmetrical.

in output power was obtained with a decided decrease in the power input by doing so. The author, belonging to the "old school", prefers to see the plates of the tubes in operation. Therefore, the glass type 6L6 tubes were incorporated in his exciter unit.

Fortunately, the circuit under discussion is not a trick circuit. Once constructed and with the proper coils in position, it is very easy to make it function. Therefore, this circuit was incorporated in a compact exciter unit, using a type 6A6 tube as a combination crystal oscillator and doubler, driving the 6L6G tubes in the now famous push-push circuit.

There is not a great deal that can be said about this particular exciter unit. It is simple and straightforward, as can be seen by the diagram. With an 80 meter crystal the output is on 20 meters. With a 40 meter crystal the output is on 10 meters, and it so happens that in this particular unit the output is of equal magnitude on both frequencies. As will be noticed in the diagram, there is no link coupling between the doubler section of the 6A6 and the input of the 6L6's. It was purposely omitted because the magnetic coupling with the coils spaced 2 5/8 inches from center to center is sufficient to drive the grids of the 6L6's within one ma. as much as it is with link coupling. To be specific, with link coupling it is possible to get 11 ma. grid drive on the 6L6's on 40 meters going into the push-push doubler,

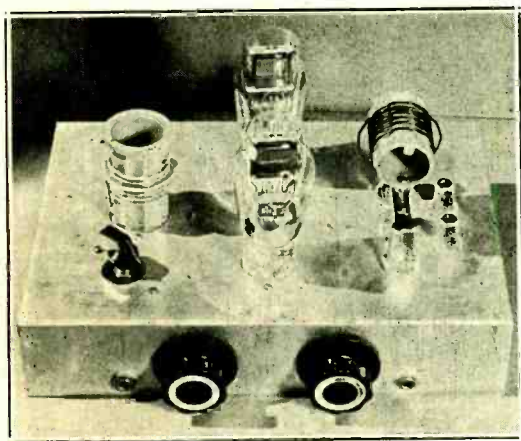

At the author's station the exciter is used to drive this 210 stage to 125 watts input on 10 and 20 meters. It is a conventional push-pull circuit.

metal tubes that for 10 meter output it was best to ground the shield or shell to the cathode, as the circuit efficiency was considerably increased in doing this. A very noticeable increase

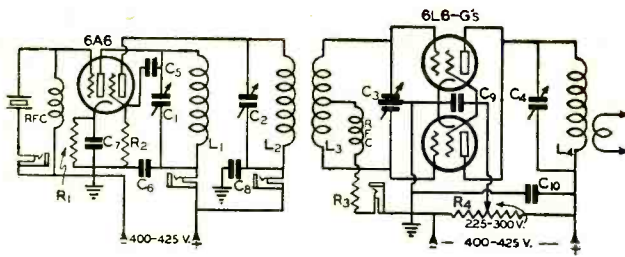

The General Wiring Diagram of the Exciter

- C₁—100 μ fd. midget
- C₂—50 μ fd. midget
- C₃—25 μ fd. per section. midget
- C₄—20 μ fd. midget. ceramic insulation
- C₅—75 μ fd. mica
- C₆ to C₁₀—0.01 μ d. mica
- R₁—400 ohms, 10 watts
- R₂—50,000 ohms, 2 watts
- R₃—50,000 ohms, 10 watts
- R₄—25,000 ohms, 50 watts (slider type)
- Coils—See coil table

whereas with magnetic coupling the grid current is 10 ma. There is absolutely no difference in the output either way.

Speaking of grid current reminds me that the reader may be interested in knowing the voltages and currents in the respective tubes used in this exciter unit. With an 80 meter crystal and the output of the 6L6's on 20 meters, the plate current of the crystal oscillator is 25 ma. at 400 volts. The plate current of the second section of the 6A6 as a doubler is also 25 ma. The grid current of the 6L6's is 10 ma. The plates of the 6L6's under load are 60 ma. This drives the neutralized 210's to 36 grid ma. The 210's are biased with about 180 volts d.c. from a bias power supply with a low resistance bleeder. This is sufficient grid drive to drive the 210's from 120 to 125 watts input with from 550 to 600 volts on the plates. None of the tubes at this frequency show any color while running continuously as in phone operation.

For 10 meter output a 40 meter crystal is used. The plate current of the oscillator section of the 6A6 is approximately 30 ma. The doubler section of the same tube is also approximately 30 ma. The grid current of the 6L6's is 8 ma. The plate circuit of the 6L6's is loaded a little heavier in this case, the plate current running from 100 to 115 ma. The grid current of the 210's is 36 ma., and the power input is from 120 to 125 watts, the same as when the rig is used on 20 meters. It is surprising to note that the tubes do not show any color at all on this frequency, and the 210's are metal-plate ones, too!

We would like to mention one peculiar factor of the 6L6's. It seems that when the grid excitation is reduced from 10 or 11 ma. to about 6½ ma., the power output is increased somewhat. Under this condition the plate current of the 6L6's increases approximately 20 to 30 ma.

In looking at the bottom view of the exciter

unit, it will be noticed that it is rather compactly built; in fact the chassis is 12 inches wide, 8 inches deep, and 2½ inches high. This is rather small for the power output of this exciter unit. Isolantite sockets are used throughout for the tubes and coil forms. The 6A6 circuit, both the crystal oscillator and doubler sections, is treated as a single circuit, and all ground returns are brought back to a single ground connection on the chassis. The same treatment is used in the 6L6 push-push doubler section. It will be seen that the two condensers used with the 6A6 are not isolantite insulated. It is quite possible that if this type condenser were used, the output of the 6A6 doubler section might be increased very slightly. As it is, the output is sufficient to drive the 6L6's. Of course, the condensers used in the 6L6 circuits are all isolantite insulated. This is necessary because the losses at the frequencies used here are extremely high with bakelite. The condenser used in the plate section is of 20 μ fd. capacity. This may seem rather small to some but it must be remembered that this particular exciter unit was made to operate only above 13 Mc.

Again looking at the bottom view of the exciter unit, there will be seen a jack on the rear of the chassis. This is a single closed-circuit type of jack. It is used to measure the crystal current. It is a very important item, and should be incorporated in each exciter unit. It is very handy, indeed, and no doubt a good many amateurs lament the fact that they have no

COIL TABLE

All wound with no. 19 push-back wire on 1½" std. forms

Band	Crystal	6A6		6L6's	
		1st Sect.	2d Sect.	Grid Coil	Plate Coil
20	80 M.	28 t. close wound 2"	20 t. close wound 1½"	30 t. close wound 2½/16"	10 t. sp. 1½"
10	40 M.	14 t. sp. to 1¾"	10 t. sp. 1¾"	14 t. sp. 1½"	4 t. sp. 1½"

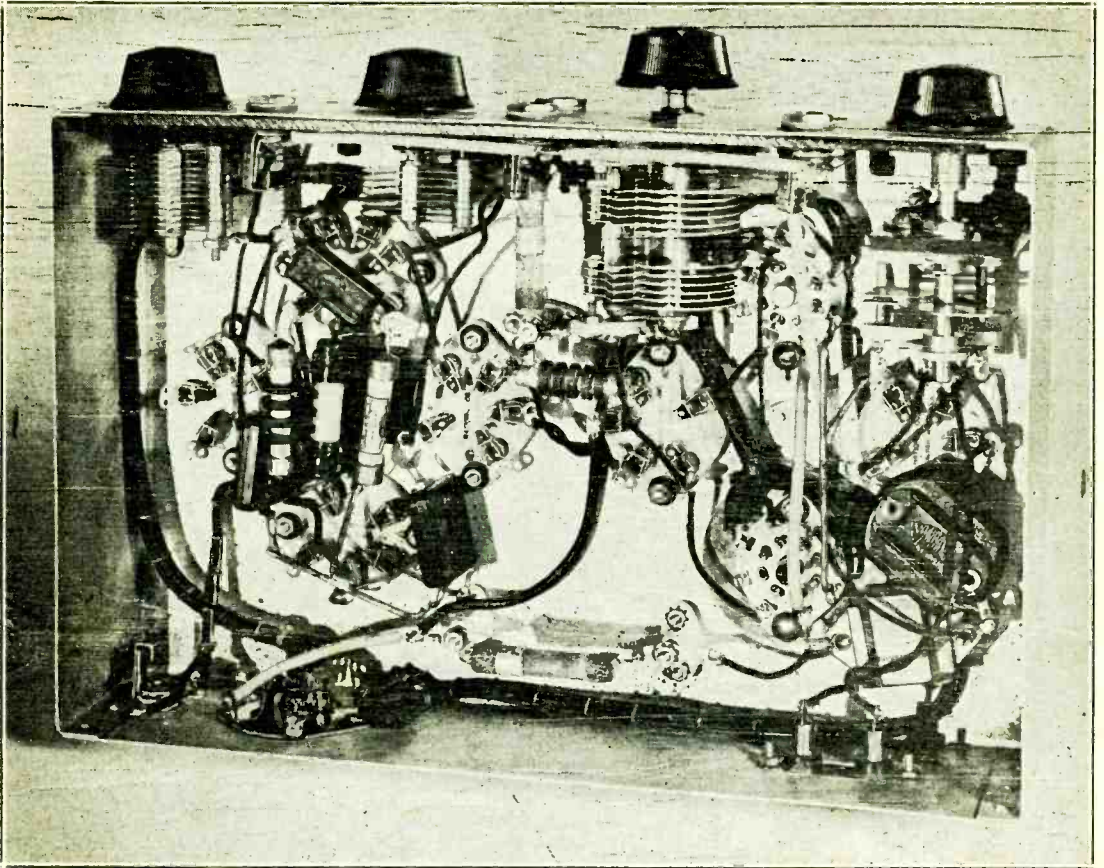

Under-Chassis View of the 6A6-6L6 Ultra High Frequency Exciter. Showing Mechanical Layout of Parts

means of checking their crystal current, especially after they have lost their pet crystal. The leads to the r.f. meter should be short and well-separated to keep down the shunt capacity of the leads.

In this particular exciter unit the crystal current with an 80 meter X-cut crystal is approximately 15 ma., and with the 40 meter crystal it is 30 to 35 ma. This is rather a low value of crystal current for 400 volts on the plate. It is so low that there should be no appreciable drift in frequency when the crystal is kept at the usual value of room temperature.

The discs on which the 6L6 tube sockets are mounted were made necessary by the fact that this particular exciter unit at first used 42 type tubes, using the larger 6 prong sockets, and as it is impossible to mount the smaller octal socket in the same mounting hole, it therefore became necessary to make discs on which to mount the new sockets.

In using a common filament transformer to light both the 6A6 and the 6L6 tubes, it is a good practice to use two .002 μ fd. mica condensers across the filament circuit at one or the other of the tubes, and to ground the center tap. On occasion there has been noticed a considerable improvement in efficiency and output.

One very important fact was learned in our experimental work, and that is that paper-insulated condensers will not work satisfactorily in the circuits used in this exciter unit. The fact that mica condensers and single ground returns for each circuit are used no doubt contributes substantially to the overall efficiency of this unit. The author prefers a voltage divider network to supply the screen grid voltage of the 6L6's, as it is possible to set this voltage at the proper point for optimum circuit conditions. These tubes seem to work best with a screen grid voltage of approximately 300 volts.

While this exciter unit is used to drive a pair

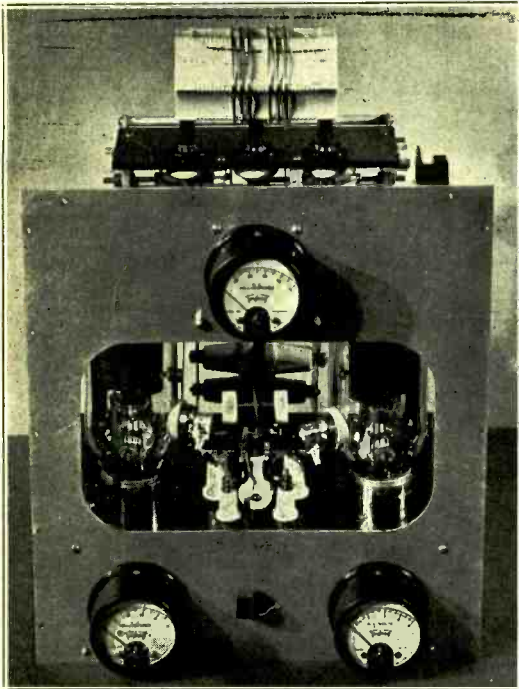

The 210's drive this 10-20 meter amplifier to nearly a kilowatt input. It uses HF200's in push-pull.

of neutralized 210 tubes, it no doubt has sufficient output to drive either a single or a pair of larger tubes on 10 and 20 meters, or on any band if suitable coils and crystal were used.

Spurious oscillations and erratic operation! The author can safely say that with the several types and makes of both metal and glass 6L6 tubes that were tried out in this exciter unit in his laboratory, and at the voltages specified, that at no time were there any spurious oscillations detected, and under no condition were the operation or results obtained in the operation of this exciter unit erratic.

The split stator condenser, C_3 , causes the grid circuit of the 6L6's to have capacitive reactance at the second harmonic, and this has the tendency to prevent the 6L6's from breaking into oscillation.

It has been pointed out previously that this exciter unit will push a pair of 210 tubes to 125 watts input for phone operation. It will interest the c.w. men to learn that the antenna coupling was increased on 10 meters to the point where the 210's were drawing 160 watts input. The tubes, which have metal plates, were showing some color under this input. It was sur-

prising that the color only showed up in a spot about $3/8$ inch in diameter on each plate. The author feels that this is too much input for phone operation, but no doubt this exciter unit will drive a pair of 210's to as much as 180 to 200 watts input on 10 meters, for c.w. operation. As it is inadvisable to run over 200 ma. on the 10's, the plate voltage should be increased to 900 volts or so (permissible for c.w. work).

All of the coils are wound on Hammarlund XP-53 five-prong coil forms, using regulation solid no. 19 push-back hook-up wire. This wire was chosen for two purposes:

First: It will stay in place much easier than enamel-covered wire when used on space-wound coils that have not had threaded grooves cut on them.

Second: It is possible to have the coils "color coded" and it is then easy to select the proper coils when changing bands. The author's coils are wound with brown-covered wire for 20-meter operation and yellow-covered wire for 10-meter operation.

[Continued on Page 168]

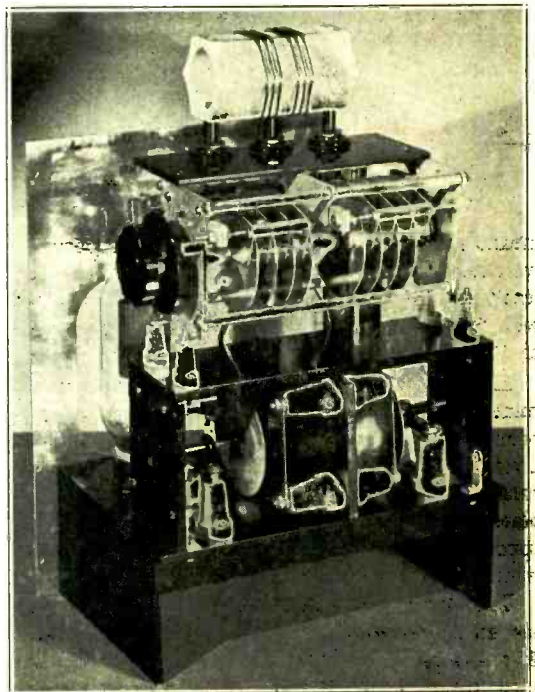

Back view of the HF200 amplifier. The circuit is conventional, but the mechanical arrangement somewhat unusual. It permits very short and direct leads.



Attacking the Grid Bias Problem

By RAY DAWLEY, W6DHG

In every case when we start to design or build a multi-stage transmitter, the problem of how to obtain the bias voltage for the various stages immediately presents itself. Usually each stage will require a slightly different biasing arrangement and a different amount of voltage. The ordinary r.f. amplifiers can be divided into the following general classifications with respect to biasing:

1. Those requiring bias only when excitation is applied, actual value of voltage uncritical.
2. Those requiring only a fixed minimum bias to limit plate current without excitation. Value uncritical with excitation.
3. Those drawing steady grid current and requiring fixed bias within limits.
4. Those that draw varying grid current and require fixed bias.

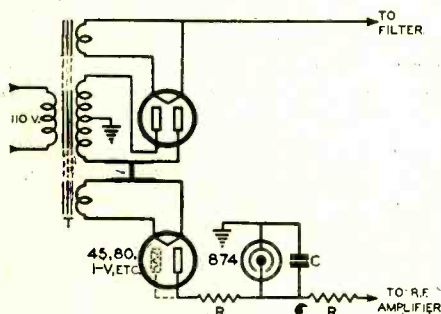

Figure 1

Tapping onto crystal oscillator or other low-power supply transformer for stabilized bias voltage

- R—50,000 ohms
- R₁—Grid leak (see text)
- C—8 μfd. paper capacitor

It can be seen from a study of the above that every normal r.f. amplifier will fall under one of the classifications.

Under group 1 come two general types of amplifiers. First, the small intermediate amplifier or doubler using a high-amplification-factor tube that draws little plate current with plate voltage applied and no excitation. Such tubes as the 46, 59, 865, 805, and similar types come under this classification. The second type is the special case of a final or intermediate amplifier that is being keyed in the plate supply. A common case

The question of negative bias is a very broad one and a very old one. But it seems to receive little attention except for incidental discussion in articles on other subjects. So here we give you a sensible approach to the whole bias problem. A careful reading will allow you to design the most suitable bias system for any given requirements, whether for r.f. or speech work.

would be that which a number of fellows are using: a 150T followed by a pair of 150T's in the

final, both stages running from one power supply that is being primary keyed. In both cases straight resistor grid leak bias is probably best. The actual value of the resistor is best determined by the cut and try method to deter-

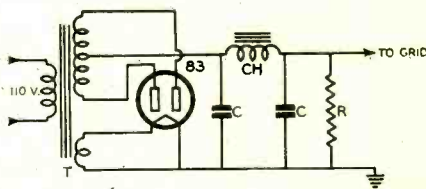

Figure 2

- C—16 μfd. electrolytics
- R—Heavy bleeder to draw 100-250 ma.
- CH—30 hy., heavy enough to handle bleeder current
- T—Husky b.c.l. power transformer

mine what value gives the best operating conditions. As a first approximation a trial value (it is usually close enough to the final value found by cut and try that the latter can be dispensed with and the trial value used if desired) can be found by looking up the rated grid bias in volts (E) and the rated grid current in amperes (I) and substituting in Ohms Law,

$$R = \frac{E}{I}$$

Then this value of resistor (of wattage about 4 times I^2R , in watts, to allow for a safety factor) is placed in the circuit and the grid current measured. If it is less than the rated value for the tube, the resistor should be decreased; if more, the resistor should be increased. The best value is that which gives the greatest bias voltage ($E = IR$) and still gives approximately the normal grid current for the tube. The above procedure of course assumes that the normal amount of excitation power is available at the grid of the tube under consideration.

Under classification 2 comes the majority of the amplifier stages found in ham rigs. Ordinary buffer stages using the majority of the



present tubes require some sort of fixed bias to limit the plate current in case of excitation failure (or if keying is used on a preceding stage). In addition to this minimum bias there must also be a source of operating bias to vary in accordance with the excitation. There are many means of obtaining this minimum bias. A few of the more conventional ones can be enumerated.

1) *Batteries*—Not to be recommended. Generally unsuitable for currents greater than 30 to 40 ma. for the large units, proportionately less for the small units. They have a bad habit of charging up and becoming noisy and unstable a short time after installation.

2) *Cathode Bias Resistor*—The use of a cathode bias resistor to limit the no-excitation plate current to a stage is satisfactory in some cases. First, it must be used with a high amplification factor tube. This becomes obvious when you consider that the amount of voltage necessary to reduce two tubes, similar except for μ , to the same *small* value of plate current is inversely proportional to their respective μ 's. Since this bias voltage is being subtracted from the plate voltage by the cathode resistor, we see that we must use a tube that requires low bias. Then, looking at the problem a little further, no matter how large a cathode resistor is used, the tube will never cut off its own plate current. It takes a certain amount of current flowing through the resistor to produce the voltage in the first place. Again, when the stage is operating, since this cathode resistor is effectively in series with the plate supply, and the more plate current we draw the less plate voltage and more bias we have, the value of this resistor must be kept to minimum. In practice, the value of the resistor must be determined experimentally. It should have the smallest value that will limit the plate dissipation of the tube to the normal rating with no excitation and full plate voltage applied.

The system has some advantages: one being that the plate current can never run wild and damage the tube, another being that the tube acts as a bleeder to its power supply. It also has the disadvantage that the power output of a tube operating under these conditions is definitely limited. High plate voltage is of no avail, since a large cathode resistor must be used to limit the standing current. And, as this resistor is still in series when the tube is operating, the plate current is again limited by this resistor. All in all, this system is good for

small, high- μ tubes in the exciter stages but is not to be recommended for higher powered amplifiers.

3) *Gaseous Discharge Tubes*—The 874 and similar argon and neon discharge tubes have the property of holding the potential across their two elements at, or very near to, 90 volts, regardless of the current through them. Different types have different maximum current ratings, but since the 874 is the only one commonly available, it will be the one considered. It has a maximum current rating of 50 ma. With one or more of these tubes (depending on the bias requirements of the amplifier) and a small amount of additional equipment, we can make a very neat and convenient bias supply. Figure 1 shows how it is done.

First, two things must be known: the amount of voltage required to cut off the plate current of the amplifier, and the maximum grid current that will flow. These can be ascertained from the tube characteristic sheets and from past experience with the tubes. For proper operation, we hook one tube in parallel (with a 100 ohm dividing resistor in series with each tube) for each 50 ma. of grid current, and a tube in series for each 90 volts of bias voltage. (The system is economically unsound, however, if more than two or three tubes are required. They cost somewhat more than an ordinary receiving tube.) The rest of the arrangement is shown in the diagram. A rectifier tube (80, 84, 1V, or 45, 47, 26, connected as a diode) with its associated filament transformer is placed near one of the low-power plate supplies delivering about 300 or 400 volts. The cathode or filament of this rectifier is connected to one of the plates of the rectifier in the power supply. Then the plate of our small bias rectifier is connected through about a 50,000 ohm resistor to the *negative* element in the 874, or the most negative element if more than one is used. Then an 8 μ fd. paper filter condenser is placed across the 874 ('s), and the positive element in the glow tube is grounded. The grid return of the stage, through its meter and grid leak, if used, is then tied on to the negative element in the 874. In this way we have a simple, fool-proof, fixed bias supply at a minimum of cost and trouble.

4) *Bias Power Packs*—The various types of bias power packs can very well be used to supply the minimum bias voltage to an amplifier. There are two main types of packs, so they

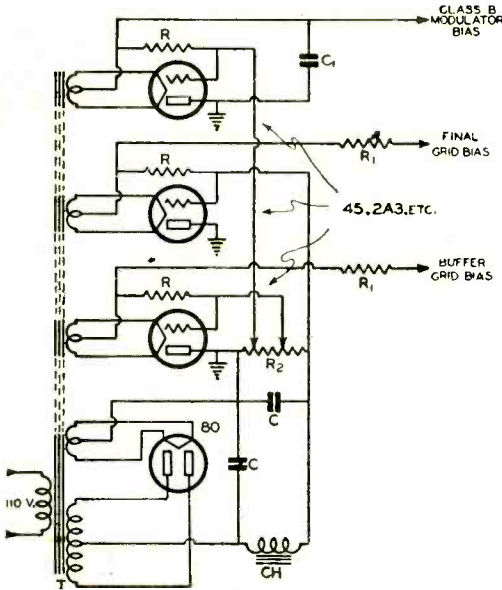

Figure 3

CH—10 to 30 hy., 75
ma.
R—1 meg., 1 watt
R₁—Appropriate grid
leaks for tubes
used
R₂—15 000 ohms, 50
watts, with slider
C—8 or 16 μfd. electro-
lytics
C₁—8 μfd. paper ca-
pacitor

T—B.c.l. power trans-
former with as
many filament
windings as possible,
any remain-
ing filaments off
another trans-
former. High-voltage
secondary 700 v.
center tapped; 75
ma. rating.

will each be described to clarify their use. The first type is shown in figure 2. It uses a conventional power pack with a fair amount of filtering and a heavy bleeder across the output. The reason for this heavy bleeder has been many times explained.

If good bias supply regulation is desired, the bleeder current of the supply should be at least twice the maximum grid current drain expected.

An excellent means* of obtaining this fixed minimum bias is that shown in figure 3. This arrangement has additional advantages over those given before in that a small power supply with an ordinary light bleeder can be used to supply every stage in the transmitter, including the class B modulator, with fixed bias or a fixed minimum bias. The only additional equipment required for each additional stage is another slider on the bleeder resistor, a 1 meg. resistor, and a tube with its filament supply. The system performs admirably. The tubes best suited for this use are the 2A3, 6A3, and 45.

About 40 ma. of grid current can be allowed for each 45 and about 65-70 ma. for each -A3. However the -A3 tubes give better regulation and are preferable to the 45's. If the grid current to be expected is greater than those values given above, additional tubes may be paralleled to give the desired rating. The actual grid bias cannot be measured by an ordinary voltmeter unless normal grid current is flowing in the circuit. It can, however, be calculated fairly accurately from the following expression:

$$E_g = E_p \frac{\mu}{\mu + 1}$$

where E_g is the actual grid bias, E_p is the voltage, measured with a high resistance voltmeter, on the bleeder clip to which the tube is connected, and μ is the amplification factor of the tube. This expression can also be used to calculate the maximum bias voltage a certain power supply will give, by substituting this voltage for E_p in the above expression and solving. For example: since the μ of a 2A3 is 4.2, we see that the actual bias voltage will be

$$\frac{4.2}{4.2 + 1}$$

or about 4/5 of whatever the voltage at the tap or the divider may be. Of course it must be remembered that a separate filament winding must be used for each regulator tube or tubes.

All these arrangements just described are primarily for the purpose of providing a fixed minimum bias. The additional biasing voltage required is most conveniently obtained by means of a leak in the grid return of the stage under consideration. Its value is conventional and can be easily found by the method described in the first of the article.

For a practical example, take the case where we have a pair of 852's operating as a plate modulated amplifier at 2,000 volts. We wish to have enough fixed bias so that if the excitation fails the plate current will be cut off. The μ for these tubes is given as 12. The cut-off bias would then be 12 into 2000 or approximately 165 volts. However, for safety's sake, 180 volts would be a better value. Now the best way to obtain this voltage would be from a voltage regulated bias pack as in diagram 3. Since the grid current on a pair of 852's will run from 75 to 100 ma., a pair of 2A3's would make the best regulator. As the actual bias voltage isn't

*Yates, QST, September, 1934.

[Continued on Page 166]



An Inexpensive, Six-Band Transmitter

By B. A. ONTIVEROS, W6FFF

It has always been the goal of all technically-minded amateurs to simplify the transmitter as much as is possible for a given power output and performance. It not only reduces the cost of the transmitter, but simplifies operation as well.

The transmitter described in this article is, in our estimation, about the ultimate in simplicity and economy. Designed for both phone

Two r.f. stages, two a.f. stages, one power supply, and a total of only six tubes including rectifier, this transmitter delivers an average output of 20 watts from 10 to 160 meters and requires but two variable condensers and a total of 8 coils for these 5 bands. For a few cents additional it may be modified to operate also on 5 meters, delivering about 5 watts on the latter band. Only two crystals are required.

working stations up to about 40 miles. Because crystal control is used, the transmitter is more

readable than a 5 meter self-excited transmitter delivering the same power.

Only two crystals are required: a 160 meter crystal for 160 and 80 meters, and a 40 meter crystal for 40, 20, 10, (and 5) meters.

The Power Supply

The power supply delivers 415 volts under full load. Allowing for the drop through the transformers, this puts about 400 volts on the 42 modulators and the 807 amplifier when modulated. On c.w. the modulation transformer is shorted out and the plate voltage removed from the speech system. This boosts the voltage on the 807 to about 440 volts on c.w.

The plate transformer used in the transmitter shown in the photo uses an old b.c.l. transformer designed for 250's in push-pull "plus the rest of the receiver". It runs sufficiently cool when delivering 250 ma. with choke input. These can sometimes be picked up for a song at salvage houses because of the fact that the filament windings are not suitable for the newer tubes. If you cannot procure one of these, a new transformer of suitable rating can be procured for five or six dollars if you shop around a bit.

The filter choke should not only be heavy enough to carry the current, but should have low resistance (not over about 100 ohms). The swinging current drawn by the modulators under modulation makes a power supply of very good regulation necessary, and a high resistance choke will spoil what might be otherwise good regulation. This swing is not as great as would occur with class B 46's, but still necessitates a power supply of very good regulation if the same power supply is to be used for the r.f. system as is done here.

The Speech System

By using a good single-button microphone, the quality on voice will be almost as good as with the most expensive type microphones, and the "speech range" response will result in an

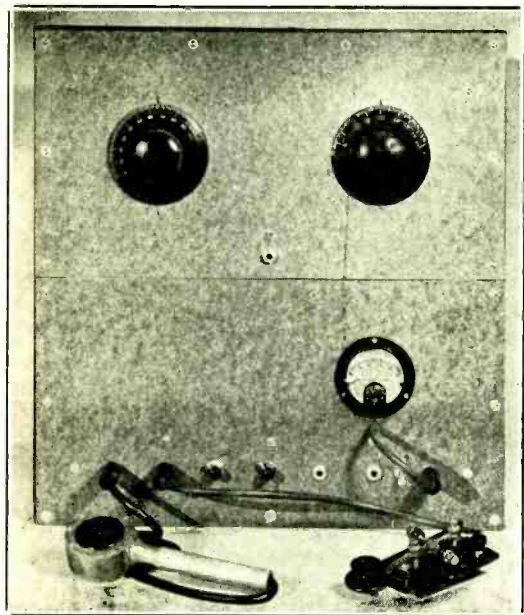

Front view of the transmitter. If desired, the Masonite panels may be given a black crackle finish and metal scale dials used.

and c.w., it delivers close to 25 watts on 160, 80, and 40 meters, slightly over 20 watts on 20 meters, and about 18 watts on 10 meters. For less than a dollar additional it may be modified to work also on 5 meters, delivering about 5 watts on the latter band. This is considerably more power output than is obtained from the common transceivers on which so many 56 Mc. dx records have been made, and one can have a good deal of fun with this power on 5 meters

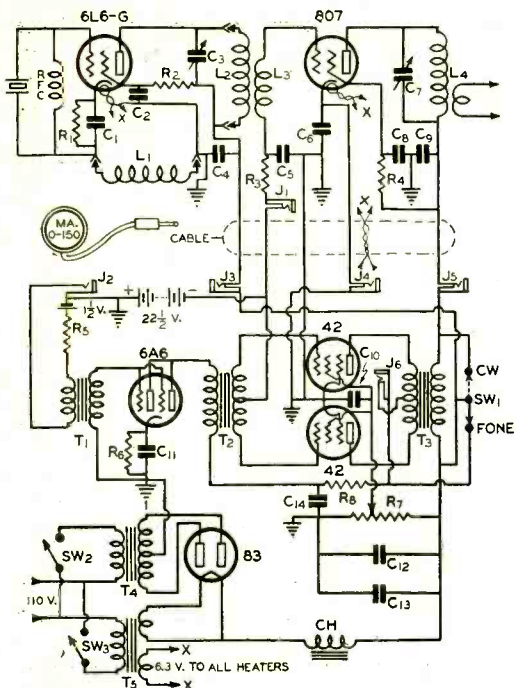

The Complete Transmitter Diagram

- | | |
|--|--|
| R ₁ —500 ohms, 10 watts, wire wound | C ₁₀ —8 μfd. midget electrolytic |
| R ₂ —20,000 ohms, 10 watts | C ₁₁ —10 μfd., 25 v. electrolytic |
| R ₃ —25,000 ohms, 2 watts | C ₁₂ , C ₁₃ , C ₁₄ —8 μfd. can type wet electrolytics |
| R ₄ —10,000 ohms, 10 watts | T ₁ —Mike-to-grid transformer |
| R ₅ —25 ohms, 5 watts | T ₂ —Small driver transformer, such as 53 to 53 class B |
| R ₆ —1000 ohms, 2 watts | T ₃ —Output transformer, 10,000 ohm pri. to 3500 and 5000 ohm sec. (such as 53 class B output transformer). Use 5000 ohm tap. |
| R ₇ —20,000 ohms, 50 watts (slider type) | T ₄ —Approx. 525 volts each side c.t., 250 or 300 ma. |
| R ₈ —10,000 ohms, 10 watts | T ₅ —5 v. 3 amp. and 6.3 v. 5 amp. |
| C ₁ —40 μfd. mica | CH—20 or 30 hy., 250 or 300 ma., not over 100 ohms |
| C ₂ —0.006 μfd. mica | |
| C ₃ —100 μfd. midget | |
| C ₄ —0.006 μfd. mica | |
| C ₅ —0.006 μfd. mica | |
| C ₆ —0.006 μfd. mica | |
| C ₇ —150 μfd. "Midway", semi-midget, receiving type | |
| C ₈ —0.002 μfd. mica | |
| C ₉ —0.004 μfd. mica | |

equivalent power gain of about 2 times. However, there are single-button mikes and there are single-button mikes. While a good one sounds surprisingly good, many makes and types sound rather "sorry". By using very low button current, the ratio of hiss to response goes down. By using about 1 volt on the microphone instead of the customary 4½ or more, the hiss level can be kept down to where it is inaudible when close-talking. The low button current will require more gain in the amplifier, but a single-button mike has high output anyhow, and the output still is quite

high even with low button current. However, if the microphone has ever been used with heavy button current, there is no point in running it at low current, as the granules probably will have been permanently damaged to the extent that some hiss will always be present.

Current for the microphone is secured from a large flashlight cell, mounted underneath the chassis that holds the speech and power supply. The mike had just a little too much gain; so the resistor R₅ was inserted, further reducing the button current. Its value will depend upon the microphone in use and how close the operator desires to talk to the mike. Between 25 and 100 ohms will usually be about right. As the button current is but a few ma., the flashlight cell will last indefinitely.

The 42's are run as class AB pentodes, and at 400 volts with fixed battery bias deliver 25 watts of audio (more than is actually needed) with very low distortion. The screen voltage tap on the divider should be adjusted so that the tubes draw about 40 ma. resting plate current. This will occur at about 250 volts screen voltage. The 42's have greater power sensitivity and require less drive than class B 46's to deliver the same power output at the same plate voltage.

Normally the removal of plate voltage on pentodes results in excessively high screen current, damaging the tubes. This is because with cathode bias the bias drops way down when the plate is no longer drawing current through the bias resistor. With fixed battery bias as is used here, especially when it is higher than normal as is required for class AB work, the screen current rises but very little, remaining at a safe value. Therefore no provision was made for cutting the screen voltage on the 42's when cutting the plate voltage to them for c.w. work.

Bias

The smallest size 22½ volt bias battery is strapped under the chassis with the microphone battery. The actual voltage of these "22½" volt batteries is closer to 25 volts. This is just right for the class AB 42's. It also is sufficient to keep the plate current on the 807 r.f. amplifier down to a safe value when the excitation is removed, the plate dissipation being only slightly more than rated maximum when the excitation is "killed". Without this fixed bias the tube will draw enough plate current when excitation is removed to damage the tube permanently in just a few seconds time.



As the grid current of the 807 is but 2 to 5 ma., and the 42's draw very little grid current, the battery will have long life even though it is very small in size and won't stand much reverse current.

The Exciter

The 6L6 exciter uses the same circuit as described by Smith in last month's RADIO. Those who have that issue will do well to read the article. Those who do not, can get the circuit to work properly by paying careful attention to the mechanical layout as shown in the accompanying photos and copying the circuit constants and coil data *exactly*. The exciter may self-oscillate when the crystal holder is removed, but if working properly will cease self-oscillating when the holder is inserted in the circuit. If self-oscillation persists, the condenser C_1 should be increased to 75 or even 100 μmfd . However, do not use a larger capacitance than necessary, as it will cut down the harmonic output.

Three coils are needed for the exciter. All are wound on XP-53 standard size $1\frac{1}{2}$ " forms with no. 20 d.c.c. wire. The first coil has 7 turns spaced to occupy exactly 2 inches. This is the output coil for 10 meter output of the exciter and the cathode coil for 20 and 40 meter output. Be sure to wire the coil sockets so that each coil may be used either in the output tank circuit or in the cathode circuit. The second coil consists of 14 turns spaced to occupy 2 inches. This is used as the output coil for 20 and 40 meter output and as the cathode coil for 10, 80, and 160 meter output. The third coil is close-wound with 52 turns of the same wire. This coil is used as the output coil on 80 and 160 meters. Unlike the first two coils, it is never used as a cathode coil. Here is what we have:

<i>Xtal</i>	<i>Cathode Coil</i>	<i>Plate Coil</i>	<i>Output Freq.</i>	<i>Plates C_3 nearly</i>
160 m.	14 t.	52 t.	160 m.	in
160 m.	14 t.	52 t.	80 m.	out
40 m.	7 t.	14 t.	40 m.	in
40 m.	7 t.	14 t.	20 m.	out
40 m.	14 t.	7 t.	10 m.	out

Thus we hit 5 bands with but two crystals and three coils. We can switch from 80 to 160 and visa versa, or from 20 to 40 and visa versa, just by tuning the condenser C_3 . Note that the condenser plates on the exciter condenser are

always nearly all the way out or nearly all the way in. With the coils set up for 10 meters, it is possible to hit the 13 meter harmonic of the crystal with the plates about a third of the way in. This harmonic should be avoided. At the 10 meter harmonic the plates will be nearly all the way out.

Coupling

A single-ended 807 has a tendency to oscillate on the higher frequencies unless carefully shielded, especially if not much excitation is available. This is due to the *additional* grid-plate circuit capacity of the wiring and components, the internal grid-plate capacity of the tube not being great enough to sustain the oscillations. By using push-pull 807's, as in the 807 amplifier described last month, the *external* feedback capacities are largely cancelled out. In other words, the external capacity from the plate circuit of one tube to the grid circuit of the other tube is almost as great as the capacity to its own grid circuit, thus in effect neutralizing the external feedback capacity.

Because a single 807 is used in this transmitter, we were afraid at first that considerable shielding would be required for stable operation on 10 and 20 meters. It was discovered, however, that because of the type interstage coupling used and because plenty of excitation was available on all bands, the 807 was sufficiently stable without shielding *so long as it was being excited*. It self-oscillates very weakly on 10 and 20 meters when the excitation is removed, but settles down and acts normal just as soon as excitation is applied. For that reason shielding was not considered necessary. Avoiding the necessity for shielding greatly simplifies the construction.

The untuned pickup coil (L_3) that provides coupling to the grid of the 807 consists of a winding of number 19 push-back hookup wire wound on each of the three exciter coils and brought out to two unused pins on the forms. The number of coupling turns on the 52 turn coil is not critical, and may be about 20 turns wound directly over the regular winding. However, the number of turns for the other two coils is somewhat critical, and some experimental "pruning" will be required for best operation. On the 7 turn coil, only 1 or 2 pickup turns will be required. With too many pickup turns, the condenser C_3 will tune "sloppily" and may even not hit resonance. With insufficient pickup turns the grid drive to the 807 will be low. The jack J_1 was provided to read

[Continued on Page 172]

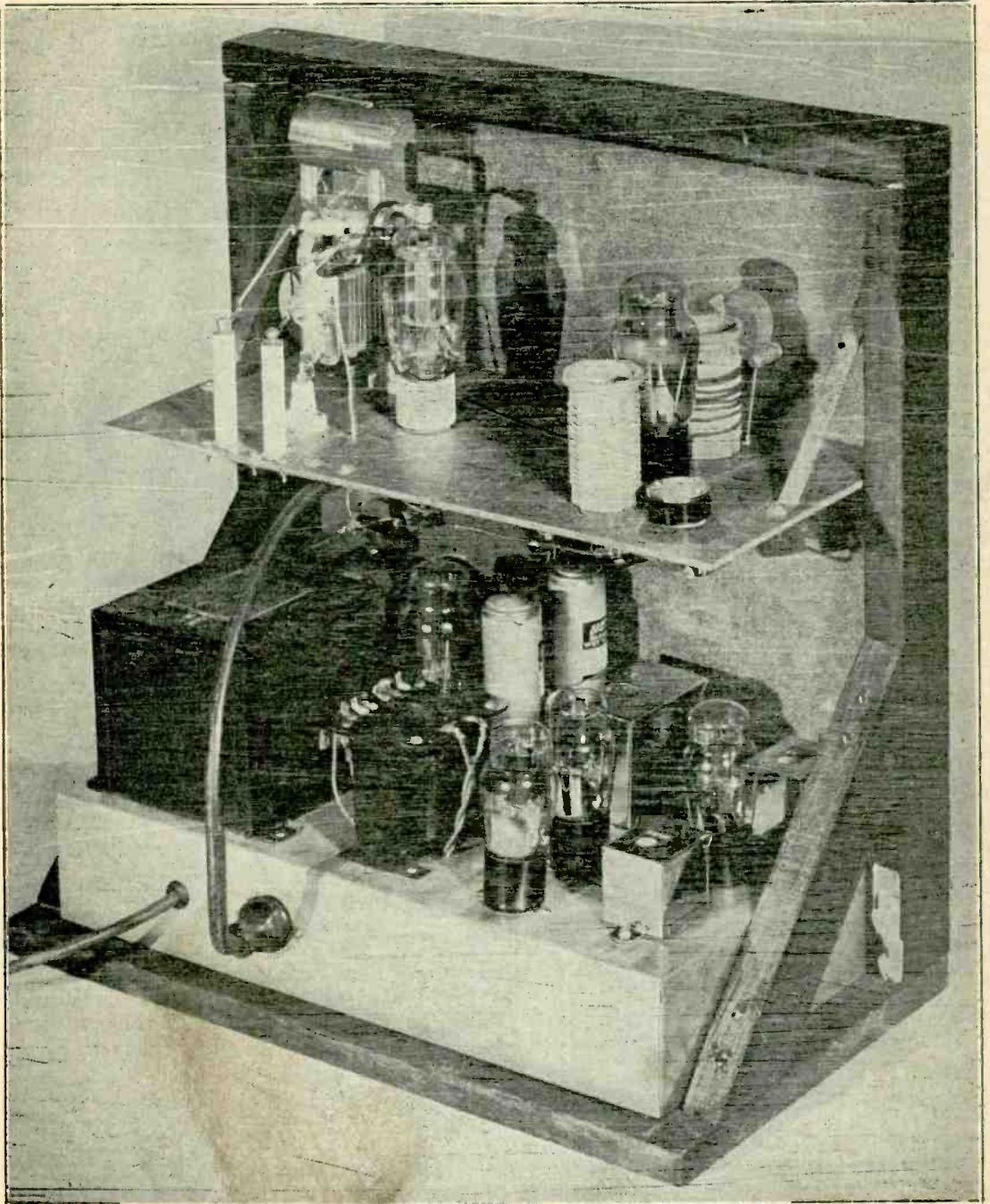

Back view of the most economical 5 to 160 meter 20 watt phone-c.w. transmitter. On the top deck we see the special 6L6 oscillator to the right and the 807 amplifier to the left. On the bottom deck is the power supply (left) and speech amplifier and modulator (right). The mike transformer should be mounted as far from the power transformers as possible, in order to avoid hum pickup.



Higher Efficiency on the Higher Frequencies

By RAY DAWLEY, W6DHG

There are a number of more or less recent developments that have made ultra-high frequency operation much simpler and more efficient. Among these, new harmonic crystal oscillator circuits, much more efficient high-frequency tubes, and improved frequency multipliers are notable examples.

This transmitter puts out nearly 200 watts on either 5 or 10 meters with efficiencies comparable to the best obtained on 20 meters with usual tank circuits. To change bands one need but change two coils and the "plumbing system". If you are interested in 5 and 10 meter crystal control, we suggest that you study the design of this combination of driver and amplifier.

A very limited introspection into the causes of the condition showed the final plate tank circuit to be

the chief offender. In cases where careful design with efficient high frequency tubes had been used, the final tank circuit was found to be practically the only offender. In one particular case, even where the other circuit parameters were favorable, the wire of the tank coil (one of these celluloid strip ones) got so hot that the celluloid caught fire and went up in sudden smoke. Naturally it takes quite an amount of power to heat up as large an area as a tank coil in this way, and the only place the energy can come from is the power generated by the tube. The high standing plate current is the result of this loss.

We can use this heating effect to ascertain where the power is being lost when a high minimum plate current is being experienced. Tune up the rig with no load connected and leave it on for a minute or two. Then turn off the power and touch the various components of the stage. In the majority of cases the tank coil and frequently the connecting jacks and plugs (if used) will be found to be some degrees above the surrounding air temperature, unless low power is being used. Very infrequently will the other parts be found offenders.

So, it seems reasonable to suppose that if there were any simple way of substituting for, or eliminating the conventional tank circuit, a pronounced increase in efficiency would be noticed.

Resonant lines, in place of tank circuits, have become standard practice in high frequency oscillators. Their much higher Q, higher available impedance, and reasonable cost make them very applicable to this use. However, heretofore this resonant line principle has found wide application only in high frequency oscillators. The majority of radio amateurs seem to have overlooked the obvious advantages of their application to high frequency amplifiers.

Experiment showed that through their use, really high efficiency was easily obtainable on

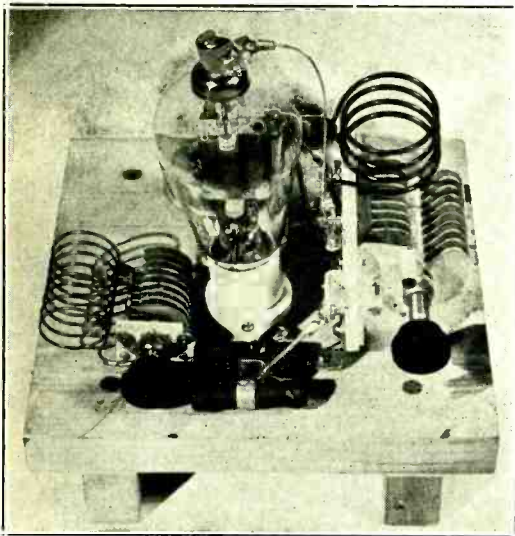

The T-55 stage, which works as a neutralized amplifier on 10 meters and as a doubler on 5 meters. The plate tank condenser is one of the new special u.h.f. type. The neutralizing condenser is hiding behind the tube.

However, even with all these new developments, the plate circuit efficiency obtainable in a conventional high frequency amplifier leaves much to be desired. Too frequently is the complaint heard, "Surely, everything works fine; plenty of excitation, everything neutralizes perfectly. But I can't get the minimum plate current on the final down." This occurrence is very common, both with new rigs designed for the higher frequencies and with conversions of lower frequency outfits. Common symptoms are: low plate efficiency; high standing plate current; undue heating of the tank circuits, and r.f. floating around the transmitter and the shack.

5 meters. Actually, operation was as straightforward and efficient on 5 as with conventional low C tanks on 80 meters. Their use, however, is restricted to the 28 Mc. and higher bands by the bulkiness of the length of line that must be used on lower frequencies. The total length of line required is slightly less than $\frac{1}{2}$ wavelength at the operating frequency. The 33 feet of line that would be required for 14 Mc. makes the system impractical.

With the aforementioned principles in mind, the transmitter to be described was designed, built, and its performance checked.

General Layout

The transmitter here described is an efficient r.f. unit with 175 to 200 watts output on the 28 and 56 Mc. bands with the tubes running at or below the manufacturer's ratings. The exciter wound up with an RK-39 as a 28 Mc. frequency doubler. As the lineup was conventional, it is not shown. It drives a Taylor T-55 buffer or power-doubler. The final amplifier utilizes a pair of Western Electric 304-B's in push-pull. Ample excitation for plate modulation of the final is obtained even on 56 Mc.

The T-55 Stage

The requirement of this stage was for a tube that would operate efficiently as a doubler from 28 to 56 Mc. with 20-30 watts output and at the same time, by changing the coil, would operate as a neutralized amplifier on 28 Mc. A

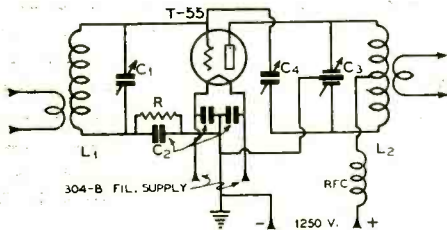

The T-55 Buffer Stage

- | | |
|---|---|
| C_1 —35 μ fd. midget, 2000 v. spacing | watts |
| C_2 —.006 μ fd. mica | RFC—U.h.f. radio frequency choke |
| C_3 —35 μ fd. per section, 4200 volt spacing, special u.f.i. type semi-midget | L_1 —8 turns no. 14, $1\frac{1}{8}$ " dia., spaced to 2" |
| C_4 —"800" type neutralizing condenser | L_2 —No. 10 enamelled wire $1\frac{1}{2}$ " dia., spaced to 2", 8 turns for 28 Mc. and 4 turns for 56 Mc. |
| R—100,000 ohms, 20 | |

few years ago these requirements could not have been met. Recently, however, there has been a whole string of tubes released that would answer the specifications. It is really rather a difficult matter to choose. The T-55 was the final choice as it gives the greatest plate dissipa-

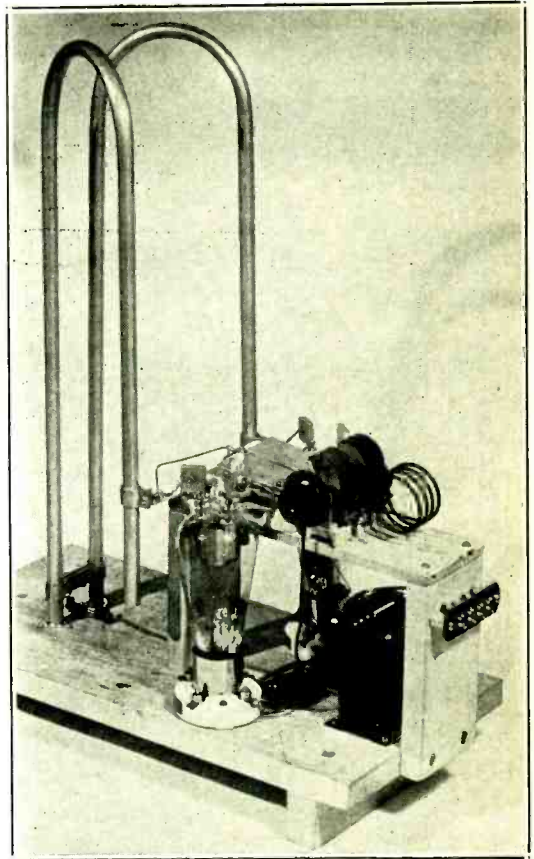

The high-efficiency 5 and 10 meter amplifier. It uses a pair of 304-B's in push-pull at 250-300 watts input. The linear tank is bent back on itself to save space. The rods shown are for 56 Mc.

tion for the least amount of money of the tubes in this group. Also it runs off the same 7.5 volt filament transformer as the 304-B's in the final.

The layout is conventional as seen by the diagram. The unit is built up on an 8" x 8" breadboard similar to that used in the oscillator. The circuit is distinguished by the 100,000 ohm grid leak and the fact that the tube is set up as a split-stator neutralized stage, both when operating straight through on 28 Mc. and as a doubler to 56 Mc. The neutralizing condenser is set at the correct point when the amplifier is operating on 28 Mc.; this adjustment is then satisfactory for operation as a doubler.

Very low "C" is necessary in the grid tank circuit to get sufficient voltage swing because of the high bias voltage (across the grid leak) required for efficient doubling. With normal excitation supplied, the grid current runs about

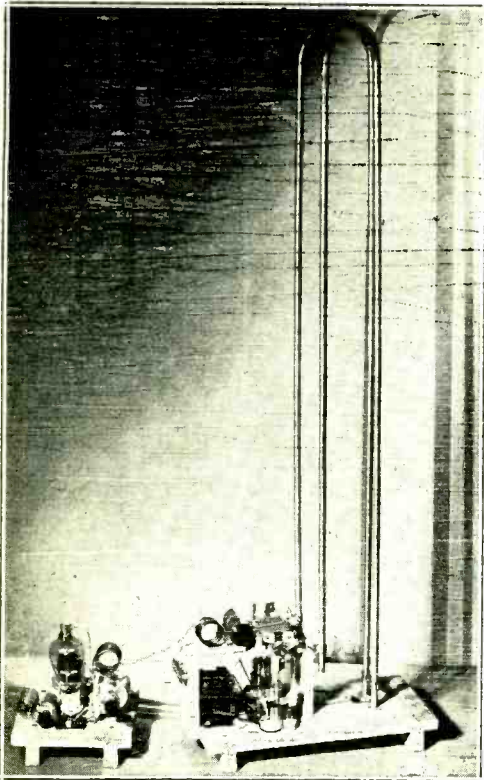

The driver and amplifier stage set up for 28 Mc. operation. The 28 Mc. rods are sufficiently rigid for the purpose, but would probably require further support if used in this way in a self-excited oscillator.

5 ma. This doesn't seem like much excitation but when you stop to consider that with 5 ma. of grid current flowing there is 500 volts of bias being produced, the reason for the low grid current is apparent. Through the use of this high bias, very good efficiency is obtained when doubling. With 1250 volts on the plate and full excitation on 28 Mc., the plate current drops from about 180 ma. out of resonance to about 40 ma. with the plate tank tuned to 56 Mc. (doubling).

The grid coil is soldered permanently into place as this circuit always is tuned to 28 Mc. The plate coil is soldered into husky copper lugs and bolted to the tank condensers, making it a comparatively easy matter to change from the 28 to the 56 Mc. coil.

With the stage set up in this manner, it is easy to obtain the recommended 50 ma. of grid current on the final stage through fairly loose coupling to this driver. The normal plate current on the T-55 is 85 to 90 ma. when doubling

to 56 Mc., and 60 to 70 ma. when running "straight through" on 28 Mc.

Actually, if it is desired to run this stage directly into the antenna, from 30 to 40 watts can be obtained on 56 Mc., and 65 to 100 watts on 28 Mc.; really quite a respectable output in itself. Still more 28 Mc. output can be obtained by using a lower value grid leak, but the doubling efficiency suffers.

The Final Amplifier

The final stage is built around some rather unconventional design principles, and it truly gives remarkably efficient performance. A good deal of the credit goes to the excellence of the Western Electric 304-B's for ultra-high frequencies, the balance to the circuit layout and the unusual tank arrangement.

The unit itself is built on an 8" x 16" breadboard with a 3" x 6" shelf mounted 5" above the center on one end of the board. Through the use of this shelf, as can be seen from the photograph, extremely short grid, plate, and neutralizing leads are made possible. The grid circuit, neutralizing condensers, and the supports for the plate ends of the linear tank rods, all are mounted upon this shelf. Down below, on the baseboard, are mounted the filament transformer, by-pass condensers, the tubes, and the other ends of the plate rods.

The grid coils are soldered into heavy copper lugs and bolted to the grid tuning condenser. This creates no serious disadvantage in changing them, and keeps losses down. The ground connection to the grid tuning condenser must be very positive and direct. In the particular type of condenser used in this job, it is important that the grounding connection be made to the front bearing; this bearing has a retainer sleeve that makes positive connection to the rotor; the back bearing does not.

The neutralizing condensers are made from four plates of 20 gauge aluminum, 1 $\frac{1}{4}$ " x 2 $\frac{1}{2}$ ". They are mounted on four Johnson 22 standoff insulators. The bottom plates are mounted by first taking off the bolt and washer that come with the insulator, then re-assembling with the aluminum sheet in their place, next to the porcelain. Then a lug for a connection is put on between the first and second nut. The end of the aluminum plate next to the opposite standoff insulator is then cut away as shown in the diagram. The top plates are mounted with a connecting lug between the first and second nuts on the standoff insulator. In this way, although using the same size insulator, the plates



have a spacing of about $\frac{1}{8}$ " when they are parallel. Actually, when neutralizing the completed transmitter, the plates are bent slightly away from each other to give the correct value. This, of course, must be determined by experiment but an approximate idea of the amount can be gained by consulting the photograph.

Connection to each of the .06 inch tungsten rods on the tops of the tubes is made by a $1\frac{1}{2}$ inch length of 26/30 stranded wire (this has little inductance and is flexible enough not to endanger the seals at the top of the tube). These are connected to special heat dissipating clamps that make connection to the elements themselves. A detail of the clamps is shown. They are made from 1" lengths of $\frac{3}{16}$ " x $\frac{3}{4}$ " brass strip drilled and tapped as in the diagram. The use of these clamps is recommended by the manufacturer for frequencies of 30 Mc. and above. The reason for their use is that their large mass assists in radiating the heat formed by the high charging currents in the lead wires.

From the photograph a general idea can be obtained of the unusual part of the stage: the linear tank circuit. These tubes are made of $\frac{1}{2}$ " o.d. no. 22 wall aluminum tubing cut to length and bent as shown. A great deal of care must be used in bending this tubing, as the author found from sad experience. Here is the proper procedure: First measure off the lengths required, two 3 foot 2 inch pieces for 56 Mc. and two 8 foot pieces for 28 Mc. These were found to be the proper lengths by experiment. Then put a pencil mark on the 8 ft. tubes, 2 in. from the center; and one on the 3 ft. 2 in. tubes, 1 in. from the center. Then put a cork in one end of the tube to be bent and completely fill it with very fine sand (beach sand is good). Keep tamping the sand by pounding the closed end on a block of wood, continually filling up the space left at the top of the tube by the receding sand. When you are tired of tamping it, and the sand does not seem to want to settle any more, pour out just enough sand from the open end of the tube to receive another tight fitting cork. Following this procedure, the tubing is ready to be bent. In our particular case this was done by very carefully and slowly bending the tubing around an old 2 qt. Mason jar, keeping our pencil mark opposite the center of the jar. Then after the bending is completed the corks are removed and the sand poured out. If this method is carefully followed, no trouble should be had. After we once "got onto" the thing everything went smoothly.

It may be noticed that while the sum of the two 28 Mc. rods is 16 ft. or very close to $\frac{1}{2}$ wavelength, the 56 Mc. tubes are only 6 ft. 4 in. total length, somewhat less than $\frac{1}{2}$ wavelength. This is explained by the fact that the capacity loading effect of the tubes and neutralizing condensers tends to increase the electrical length of the rods; consequently their actual physical length must be reduced so that they will resonate properly. If 112 Mc. operation were also contemplated, the tubes would be still less than

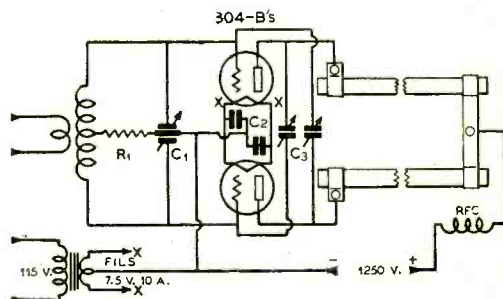

The 200 Watt Amplifier

- C₁—35 μ fd. per section transmitting type midget
- C₂—.005 μ fd. mica
- C₃—Home-made neut. condensers. described in text

- R₁—7500 ohm. 25 watt resistor
- RFC—U.h.f. radio frequency choke
- Grid coils are duplicates of the plate coils used in the T-55 stage.

$\frac{1}{2}$ wave long. They would probably be 17 or 18 in. on each side.

The clamps that hold the plate ends of the aluminum tubes are made from $\frac{1}{16}$ " x $\frac{1}{2}$ " strip brass bent so that as the bolt in the center of the National GS-1 standoff is tightened, the clamp will tightly hold the resonant tubes. The sliding clamp that acts as a shorting bar for the junction of the tubes is made of the same strip brass as the above clamps. The back half of the clamp is tapped for a 6-32 bolt and the front half has a clearance hole for this bolt. In this way the bolt, with a lug behind it, is run in and cinched tight to the back section; then the front section is slipped over this bolt and a thumb-nut run on to tighten or loosen the tension on the tubes. This makes a convenient way of sliding and cinching the resonator bar (to tune the tank).

The supports for the lower ends of the tubing are made as shown in the diagram; the bases from the National GS-1 insulators used before form the mounts, and the plugs are made by cutting some one-inch pieces of aluminum rod that will just fit snugly inside the ends of the tubes. These rods are then tapped in the bot-

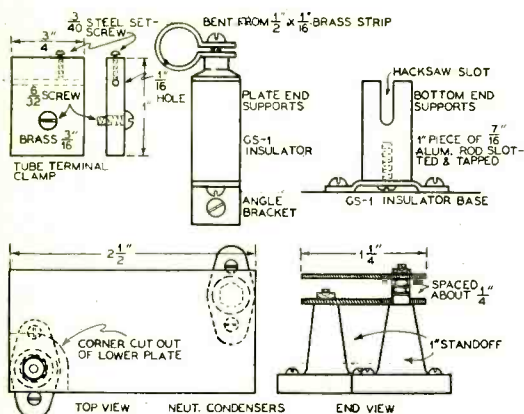

Upper left: heat-radiating connectors for the tubes. They are made of brass, as copper is too hard to machine. Upper center: Detail of plate-end supports for the rods. Upper right: Base studs for supporting the aluminum tubing. The tubing fits snugly over them. Bottom: Construction of neutralizing condensers.

tom, slotted down about $\frac{1}{2}$ in. from the top, and mounted upon their bases at $2\frac{1}{2}$ in. spacing of centers.

Tuning up of the final stage is easily accomplished if the linear tubes are the correct length. The grid circuit is tuned to resonance by means of a grid milliammeter temporarily inserted in series with the grid leak. With normal excitation the grid current on either band is from 40 to 50 ma. Then, with the appropriate plate tubes in, and the plate voltage off, the slider is slowly moved up and down the rods in the vicinity of their bases; at the same time the grid meter is carefully watched for any fluctuation. At some point (about 1 in. up from the bottom on both bands in our case) there will be a pronounced kick in the grid meter. Then the plates of the neutralizing condensers are bent slightly, both the same amount, and the meter again watched for a kick. By repeating this process, exactly the same as ordinary neutralization, a point will soon be reached where there is no more grid current kick as the jumper is slid through resonance. Then, setting the slider at the approximate place where the rods did resonate, apply the plate voltage. By making slight further adjustments in the position of the slider the plate current may be brought to a remarkably low value. Actually, with 1250 volts on the plate, the plate current would dip to from 8 to 15 ma. on both 28 and 56 Mc., truly a "remarkable dip" considering the frequencies involved.

The output of the stage can be coupled to a

load either by a link coupled to the junction of the two bars or, if a transmission line is being used, by sliding a pair of connections (National 866 clips work well) up the rods the same amount until the proper plate current is obtained.

On 56 Mc., at the full tube rating of 200 total ma. at 1250 volts, a 200-watt lamp as a load lit up very close to normal brilliancy, and the plates of the tubes remained without appreciable color. The same performance was duplicated on 28 Mc.; in fact there seemed to be very little difference in the operation on the two bands.

To change bands one merely has to change the plate coil on the T-55, the grid coil on the 304-B's, and the linear "rods" (tubing).

6L6 EXCITER NOTES

The value of the screen dropping resistor in the 6L6 exciter described by Smith in the December issue was inadvertently omitted. The value of this resistor is 20,000 ohms, 5 or 10 watts.

This oscillator cannot be keyed in the cathode lead as is often done with conventional crystal oscillators. The cathode circuit is "hot" and key leads will disturb the circuit, which is somewhat critical.

Many amateurs have commented upon the fact that their exciters go into self-oscillation when the crystal holder is removed. So long as these oscillations cease when the holder is inserted there is nothing to worry about. If, due to different mechanical layout, the circuit persists in self-oscillating with the crystal holder in the circuit, the cathode bypass should be increased from 40 μ fd. to about 100 μ fd. However, one should use as small a value as is possible, as it increases the high frequency harmonic output to do so. If the layout is followed carefully, the original values should work satisfactorily.

The circuit does not go into self-oscillation just because the crystal is not oscillating; the removal of the holder disturbs the circuit capacity, causing the oscillation. Instability is not indicated unless the self-oscillations occur with the holder in the circuit.

Push Pull 6L6 Oscillator

The value of the screen resistor, R_2 , in the push-pull 6L6-G crystal oscillator shown last month (p. 59) should read "10,000 ohms" instead of "100,000 ohms".



A \$100 SKY WIRE, OR QRO?

Amateur transmitting antennas are much like the weather in that everyone talks a lot about them, seldom does anything about them, and never knows just exactly what to expect from them. We are still using "gas lamps" in so far as our antennas are concerned. A hasty survey shows that approximately 80% of the amateurs are using single-wire-fed, Marconi or antenna-counterpoise (160 meters), "zepp.", or doublet (center fed) antennas, fundamentally the same types as were popular 8 years ago. There is nothing wrong with these antennas; it just pains us to think we know little about transmitting antennas suitable for general use that we did not already know in 1927. Or is the trouble that we don't use all the knowledge that we do know about these antenna systems?

The Expensive "Cheap" Antenna

Did you ever stop to consider what a small percentage of the total expenditure invested in the station (both time and money) is represented by the radiating system of the run-of-the-mill amateur station? We know of 1 kilowatt stations, costing upwards of one thousand dollars, that are sporting antenna systems that cost less than \$10 to erect. Certainly the antenna *may* be a good one even if it did cost but \$10 worth of wire, wood, insulators, and nails. But decibels get more and more expensive as the power goes up, a 3 db. loss representing 500 wasted watts at the 1 kilowatt level. For that reason it seems any 1 kilowatt station would be perfectly justified in spending at *least* \$100 on the radiating system. A good antenna costs almost as much for 5 watts as for 1000 watts, this being a fixed charge. But with our 5 watt station it would be more economical to raise the power a bit rather than spend all the \$100 on antenna. The amount of cash that can expediently be spent on the antenna system (percentage of the total cost of the transmitter) will vary with different locations, running from about 10% for a good location to about 20% for a poor location. In a bad location we judiciously may spend more money to get our antenna "above the mess".

To give you an idea of how a few dollars may be spent to great advantage on improving an antenna system, let us cite a few examples:

The station in question was using ordinary twisted no. 14 rubber covered for a "twisted pair" transmission line to a half-wave, horizontal Hertz. A sensitive field strength meter was

set a couple of hundred yards from the antenna and the feeder was then changed over to "tailor made" 72 ohm feeder cable expressly designed for the purpose. The cable cost \$4.97 including postage and tax. The current-squared thermomilliammeter in the field meter went up 42% when the input to the transmitter was adjusted to the previous value. The station was made up of some \$200 worth of radio equipment (not including the receiver). And for \$4.97 we increased the radiated power by 42%!

In another case, substituting really good manufactured spacers for "oiled wood" spacers on a zepp. increased the power by 57%, at a total cost for spacers of \$2.40.

Another ham we know spent \$3.50 for materials to make a good, low resistance ground, and bought \$2.50 worth of insulators to break up the guy wires on the poles holding his 160 meter Marconi. His reports immediately went up one "R", indicating an effective power gain of about 4 times.

While on the subject of taking average reports as a basis of comparison, we will admit that it is not an extremely accurate method of comparing results. But neither can we always go by the field strength meter.

The "Lying" Field Strength Meter

As far as indicating how much power we are putting into a distant point, the field strength meter is as big a liar as the antenna ammeter... *when changes are made in the antenna itself.* If we are merely fiddling with the feeder system, a field strength meter or an antenna ammeter will tell us how much more or less we are putting out. But when changes are made in the antenna itself, it is a different story. Remember when we raised the height of the "antenna" portion of our old antenna-counterpoise radiator and our reports went way up—in spite of the fact that the increased spacing between the two halves of the antenna caused the antenna current to drop 30%? The same holds true with our field strength meter. It is o.k. to check the effectiveness of different feeder systems when working into a given antenna, but n.g. for checking different antennas or changes in the antenna itself (radiating portion). One antenna may have a strong ground wave, or low angle radiation, and give a much greater indication on the field strength meter even though it may produce less signal strength 1000 miles away than another antenna that gives a lower reading on the field strength meter.



Connecting Condensers in Series*

It frequently happens that condensers are needed in a circuit which develops a high voltage while the constructor does not have available condensers of the proper voltage ratings. It is then often the practice to connect several lower-voltage condensers in series in the hope that they will serve as well as a single high-voltage condenser. When using d.c. this may result in a breakdown of all condensers—the best one going first—unless special precautions are taken.

The idea that two condensers in series will have only half the applied voltage across each of them is probably borrowed from alternating current theory or of the academic case of perfect condensers which have no leakage. Such condensers, however, have never been made yet and consequently the voltage does not divide

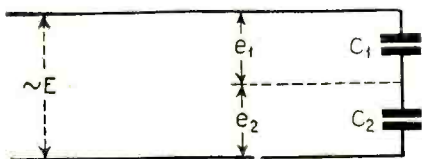

Figure 1

equally across the condensers with d.c. applied to them. In the following paragraphs we shall briefly review the reasons for this and suggest a cure.

Series Condensers in A.C. Circuits

In a.c. circuits the voltage across any impedance element (a resistor, condenser, inductance, or combination of these) is given by Ohm's Law for alternating current circuits:

$$E = IZ \quad (1)$$

In the case of several condensers in series, the current, I , passing through them is the same and consequently, the voltage across each one of the condensers is proportional to their impedance.

In figure 1 two condensers C_1 and C_2 are connected across an alternating voltage source delivering E volts at a frequency f . First assume that $C_1 = C_2$ then, according to equation (1) the voltages e_1 and e_2 are proportional to the respective impedances or rather reactances of C_1 and C_2 . The reactances of C_1 and C_2 are equal since their capacity is equal, therefore in this case $e_1 = e_2$.

On the other hand, suppose C_1 equals $1 \mu\text{fd}$.

and C_2 equals $5 \mu\text{fd}$. Assume that E is 600 volts and the frequency 60 cycles. The voltages e_1 and e_2 are now found as follows:

$$\text{Reactance of } C_1 = \frac{1}{6.28 \times 60 \times 1 \times 10^{-6}} = 2650 \text{ ohms}$$

$$\text{Reactance of } C_2 = \frac{1}{6.28 \times 60 \times 5 \times 10^{-6}} = 530 \text{ ohms}$$

$$\text{Total reactance in the circuit: } 2650 + 530 = 3180 \text{ ohms}$$

$$e_1 = \frac{2650}{3180} \times 600 = 500 \text{ volts}$$

$$e_2 = \frac{530}{3180} \times 600 = 100 \text{ volts}$$

This example shows that the largest condenser has the smallest voltage across it; the voltage is inversely proportioned to the capacity. The capacity of the series combination, of course, is found by the usual formula

$$C = \frac{C_1 C_2}{C_1 + C_2} = \frac{1 \times 5}{1 + 5} = \frac{5}{6} \mu\text{fd.}$$

The resultant capacity is therefore *smaller than the smallest* of the condensers in the series combination.

Series Condensers in D.C. Circuits

An ideal condenser would be a device which had nothing but capacity: i.e. no resistance either in series or in parallel and no dielectric losses. If such a condenser could be made, voltages across condensers of equal capacity would indeed be equal. However, even the best condensers have a certain amount of leakage which



Figure 2

in this case determines how the voltage is going to be divided. As soon as the initial rush of current, which charges the condensers, is over, the behaviour of condensers in a d.c. circuit is just like high resistances. If two condensers of

*By the Engineering Department, Aerovox Corp.



the same capacity are employed and both are new, the insulation resistance of one may easily be twice that of the other and yet both may be perfectly good condensers which would pass any standard test. When the condensers are old, or when one is older than the other or when one has seen more service than the other, the insulation resistance of one could easily be ten times as much as that of the other and the ratio can be even worse.

Bearing in mind these remarks, let us look what will happen when two condensers of unequal insulation resistance are connected across a d.c. voltage supply. Figure 2 illustrates a power supply of 700 volts with two condensers connected across it. Assume that C_1 and C_2 are 2 μ fd. each and that the insulation resistance of C_1 is 500 megohms and that of C_2 , 2500 megohms. The equivalent circuit is shown in figure 3. Since the voltage across the condensers is now proportional to their resistances, we have:

$$e_1 = \frac{500}{2500 + 500} \times 700 = \frac{700}{6} \\ = 118 \text{ volts}$$

$$e_2 = \frac{2500}{2500 + 500} \times 700 =$$

$$\frac{5}{6} \times 700 = 582 \text{ volts}$$

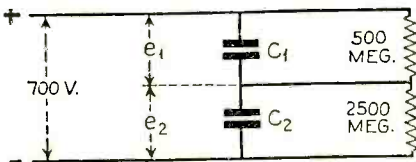

Figure 3

The result is now that C_2 , which is the best of the two condensers, will break down first. As soon as this has happened, all the voltage is across C_1 and that one will break down too. The breakdown may not happen immediately but since the condenser is connected to a voltage much higher than it is designed for, its life will be greatly shortened. It is variously estimated that the useful life is inversely proportional to the fifth power or the seventh power of the applied voltage. This would mean that, to apply twice the rated voltage divides the useful lifetime by 32, at least!

Taking another example: In a power supply of 1000 volts, three 400 volt condensers of

equal capacity are used, having insulation resistances as follows: C_1 , 1000 megs; C_2 , 1000 megs; C_3 , 2000 megs. This makes a total of 4000 megs. Consequently the voltage across the three condensers is

$$e_1 = \frac{1000}{4000} \times 1000 = 250 \text{ volts}$$

$$e_2 = \frac{1000}{4000} \times 1000 = 250 \text{ volts}$$

$$e_3 = \frac{2000}{4000} \times 1000 = 500 \text{ volts}$$

This shows again that C_3 is overloaded and is likely to break down. Meanwhile the constructor may have imagined that his combination was good for 3 times 400 or 1200 volts.

The Remedy

The difficulty can be overcome by connecting resistors across the condensers. The value of the resistors should be chosen so as to be low compared to the insulation resistance of the condensers. On the other hand they should

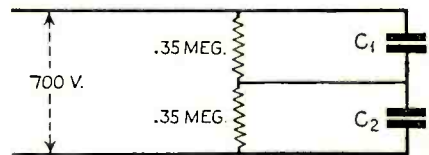

Figure 4

be high enough not to interfere with the operation of the circuit wherein they are used. This value will have to be determined for each case, but generally an additional drain of 1 ma. will not do any harm and will result in satisfactory division of the applied voltage.

Consider again the problem of figure 2, now redrawn with shunt resistors of .35 meg. each, in figure 4. The equivalent circuit appears in figure 5. It can be considered that two resistances, one of 500 megs. and one of 350,000 ohms are across C_1 ; similarly, 2500 megs. and 350,000 ohms are across C_2 . The resultant resistance across C_1 is then

$$\frac{500 \times .35}{500 + .35} = \frac{175}{500.35} = .3497 \text{ meg.}$$

Across C_2 there is a total resistance of

$$\frac{2500 + .35}{2500 \times .35} = \frac{875}{2500.35} = .3499 \text{ meg.}$$



The voltage now divides in proportion to these resistance values; hence, the voltage across C_1 is

$$700 \times \frac{.3497}{.3497 + .3499} = \frac{.3497}{.6996} \times 700 = 349.9 \text{ volts}$$

The voltage across C_2 is

$$700 \times \frac{.3499}{.3497 + .3499} = \frac{.3499}{.6996} \times 700 = 350.1 \text{ volts}$$

This illustration shows the effectiveness of the method, since the difference is now only .2 volts. There are those who will object that this will detract from the filtering efficiency of the condenser combination. Let us see whether it does. Taking an unfavorable case, assume that both condensers were 2 μ f. condensers. Then the resulting capacity is 1 μ f. If the frequency to be filtered out is 60 cycles, the equivalent series resistance corresponding to a parallel resistance of 700,000 ohms is:

$$r = \frac{Xc^2}{R} = \frac{1325^2}{700000} = 2.5 \text{ ohms}$$

The power factor due to this resistance alone would be

$$\frac{2.5}{1325} \times 100 = .19\%$$

The *Research Worker* for October and November, 1934, amply explains the unimportance of such a small amount of series resistance. In fact, the resistance across the condensers could be much smaller without seriously impairing filtering efficiency.

Summary

1. Condensers can be connected in series to obtain a higher voltage rating, if all condensers are of the same capacity. This can be done with paper, oil or electrolytic condensers.
2. It is recommended that the total voltage rating of the series condensers exceed the applied voltage. For instance, it is best that four 400 volt condensers be used for a 1200 volt power supply, 3 electrolytics of 500 volts to be connected across 1000 volts, etc.

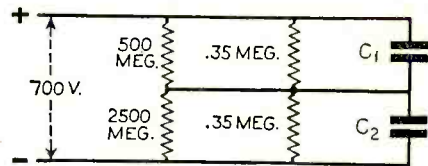

Figure 5

3. As a safety measure, it is essential that resistances of equal value be connected across each condenser. These resistances should have values which are small compared to the insulation resistance of the condensers.
4. Contrary to popular opinion, these resistances are not detrimental to the operation of a filter, even if they are as low as 100,000 ohms.
5. The capacity of the combination of condensers is equal to the capacity of one condenser divided by the number of condensers in series.

The Joys of Being Editor

Getting out this magazine is no picnic.
 If we print jokes people say we are silly;
 If we don't they say we are too serious.
 If we clip things from other magazines
 We are too lazy to write them ourselves;
 If we don't we are stuck on our own stuff.
 If we stick close to the job all day,
 We ought to be out hunting up news.
 If we do get out and try to hustle,
 We ought to be on the job in the office.
 If we don't print contributions,
 We don't appreciate true genius;
 If we do print them, the magazine is filled with
 junk.
 If we make a change in the other fellow's write-
 up, we are too critical.
 If we don't we are asleep.
 Now like as not some other guy will say,
 We swiped this from some other magazine—
We did.

Most powerful call in the U.S.—W9HP (nine horsepower); Weakest—W1MW (microwatt, not milliwatt).

The OM's have both the OM and OW calls in all nine call areas.

The abbreviation SS on the affidavit of your license application is one of those things. Legal experts declare that nobody knows the meaning of the letters which slipped into legal forms long years ago and stuck.



A "Db" Volume Control

By LELAND D. PATTERSON*

Many of us can't afford a 12 db. calibrated volume control. But by buying a few resistors and a rotary switch and doing a little work you can build one that will serve most receiving purposes.

It is necessary to decide first how many decibels you have to attenuate. This is done by changing the voltage or power gain into db. Then decide how many db. per step you want to drop. The average attenuator has a 6 db. loss per step, but for music 3 db. per step is better. These volume controls may be used in either the plate or grid circuits. After experimenting with "metallized", wire-wound, and carbon resistors, carbon resistors are now used, with changes being made as they become noisy. Some wire-wound resistors have too much distributed capacity and attenuate the high frequencies.

The design presented here is of the grid type, having a loss of 30 db. in 3 db. steps. This requires 10 steps and an "off" position. The whole control, which serves as a grid resistor, is to have a resistance of 250,000 ohms. We will call this R_g . The calculation of the steps follows.

The voltage-drop in a resistor is proportional to the resistance.

$db. = 20 \log (\text{voltage } E_2 / \text{voltage } E_1)$. But since the voltage is proportional to the resistance this may be written:

$db. = 20 \log (R_2 / R_1)$ where $R_2 = R_g = 250,000$ ohms.

We are dropping 3 db. per step; therefore $3 \text{ db.} / 20 = \log (250,000 / R_1)$ from which $R_1 = 250,000 / 1.413 = 176,500$ ohms.

Step No. 1: $250,000 - 176,500 = 73,500$ ohms.

Step No. 2: $176,500 / 1.413 = 124,800$. $176,500 - 124,800 = 51,700$ ohms.

Step No. 3: $124,800 / 1.413 = 88,000$. $124,000 - 88,000 = 36,000$.

Step No. 4: $88,000 / 1.413 = 62,300$. $88,000 - 62,300 = 25,700$ ohms.

Step No. 5: $62,500 / 1.413 = 44,000$. $62,300 - 44,000 = 18,300$ ohms.

Step No. 6: $44,000 / 1.413 = 31,200$. $44,000 - 31,200 = 12,800$ ohms.

Step No. 7: $31,200 / 1.413 = 22,000$. $31,200$

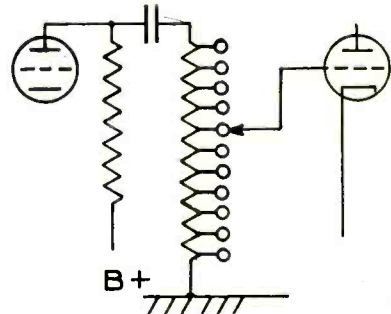

In order to pass the bass frequencies without attenuation and to make the calibration hold good for all frequencies down to 100 cycles, the grid coupling condenser should be large—at least .05 μ d. Be sure it is a good one; if a 0-5 meg. ohmmeter gives more of an indication than an initial "kick" when the condenser is tested for leakage, try another make and use the leaky one to shunt around a resistor somewhere—or throw it out.

—22,000—9,200 ohms.

Step No. 8: $22,000 / 1.413 = 15,600$. $22,000$

—15,600—6,400 ohms.

Step No. 9: $15,600 / 1.413 = 11,000$. $15,600$

—11,000—4,600 ohms.

There are 11,000 ohms left, but if we used that much it would make a thud, and it is not necessary to use it. Therefore we will use 3000 ohms for step No. 10.

For a control to be used in a plate circuit we could use the same formula and procedure but in buying the resistors for the plate circuit it would be necessary to get resistors of adequate wattage rating.

This type of control can also be used in push-pull stages. Only you use a 2-gang rotary switch and two sets of resistors—one for each tube.



Very often our strays and radioddities feature some unusual name or location. Never do we make any such mention except in the spirit of good fun or for educational purposes. But, once in a while we get a retort on these. Now, we would like to say that our intentions are always the very best and we would not offend knowingly. We study each and every lead and contribution carefully, censoring whenever we might be construed as poking fun at someone. If we have ever slipped up, we are sorry. Ok?

*818 W. 42 Place, Los Angeles



The Future of Television

By DAVID SARNOFF*

(In view of the public interest in the promise of sight as well as of sound through the air, the Radio Corporation of America invited newspapermen to witness an experimental television test in order that the progress in this new and promising art could be reflected to the public factually rather than through the haze of conjecture or speculation. The following is Mr. Sarnoff's statement to the press.)

You will recall that our field tests in television began only on June 29 of this year. That date marked the beginning in this country of organized television experiments between a regular transmitting station and a number of homes. Since then we have advanced and are continuing to advance simultaneously along the three broad fronts of television development—research which must point the road to effective transmission and reception; technical progress which must translate into practical sets for the home the achievements of our laboratories; and field tests to determine the needs and possibilities of a public service that will ultimately enable us to see as well as to hear programs through the air. On all these fronts our work has made definite progress and has brought us nearer the desired goal.

First and as of immediate interest, let me tell you the progress of our field tests. As you know, we have been transmitting from our television station on top of the Empire State Building in New York City which is controlled from the NBC television studios in the RCA Building. We have observed and measured these transmissions through a number of experimental receivers located in the metropolitan area and adjacent suburbs. The results thus far have been encouraging, and instructive. As we anticipated, many needs that must be met by a commercial service have been made clear by these tests.

We have successfully transmitted through the air, motion pictures as well as talent before the televisor. The distance over which these television programs have been received has exceed our immediate expectations. In one favorable location due to the extreme height of our transmitter, we have consistently received transmissions as far as 45 miles from the Empire State Building.

The tests have been very instructive in that

we have learned a great deal more about the behavior of ultra short waves and how to handle them. We know more about interferences, most of which are man-made and susceptible of elimination. We have surmounted the difficulties of making apparatus function outside of the laboratory. We have confirmed the soundness of the technical fundamentals of our system, and the experience gained through these tests enables us to chart the needs of a practical television service.

We shall now proceed to expand our field test in a number of ways. First, we shall increase the number of observation points in the service area. Next we will raise the standards of transmission.

In our present field tests we are using 343 line definition. Radio Corporation of America and the radio industry have, through the Radio Manufacturers Association, recommended to the Federal Communications Commission the adoption of 441 line definition as a standard for commercial operation. Our New York transmitter will be rearranged to conform to the recommended standards. That also means building synchronized receivers to conform to the new standards of the transmitter. Synchronization of transmitting and receiving equipment is a requirement of television that imposes responsibilities upon those who would furnish a satisfactory product and render a useful service to the public. On the one hand, standards cannot be frozen prematurely or progress would be prevented, while on the other hand, frequently changing standards means rapid obsolescence of television equipment.

Basic research is a continuing process in our laboratories not only that the problems of television may be solved but also to develop other uses of the ultra short and micro waves which possess such vast potentialities in this new domain of the ether.

While we have thus proceeded on the technical front of television, the construction and operation of television studios have enabled us to coordinate our technical advance with the program technique that a service to the home will ultimately require. Today, you are the guests of RCA's broadcasting unit—the National Broadcasting Company. Under the direc-

*President Radio Corporation of America.



tion of its president, Mr. Lenox Lohr, the NBC has instituted a series of television program tests in which we have sought to ascertain initial requirements.

Ten years ago the National Broadcasting Company began a national service of sound broadcasting. Now it enters upon its second decade of service by contributing its facilities and experience to the new art of television.

One of the major problems in television is that of network syndication. Our present facilities for distribution of sound broadcasting cover the vast area of the United States and serve its 128,000,000 people. Similar coverage for television programs, in the present state of the television art, would require a multiplicity of transmitters and network interconnection by wire or radio facilities still to be developed.

Our program is three fold; first we must develop suitable commercial equipment for television and reception; second, we must develop a program service suitable for network syndication; third, we must also develop a sound economic base to support a television service.

From the standpoint of research, laboratory development, and technical demonstration, television progress in the United States continues to give us an unquestioned position of leadership in the development of the art. In whatever form such progress may be evident in other countries, we lead in the research which is daily extending the radio horizon, and in technical developments that have made possible a transmitting and receiving system that meets the highest standards thus far obtainable in field demonstration.

We are now engaged in the development of studio and program techniques that will touch upon every possibility within the growing progress of the art. The distinction between television in this country and abroad is the distinction between experimental public services undertaken under government subsidy in countries of vastly smaller extent, and the progressive stages of commercial development undertaken by the free initiative, enterprise and capital of those who have pioneered the art in the United States.

While the problems of television are formidable, I firmly believe they will be solved. With the establishment of a television service to the public which will supplement and not supplant the present service of broadcasting, a new industry and new opportunities will have been created.

PHONE FIDELITY

In designing or purchasing an output transformer or modulation choke it is desirable to find out the inductance of the coupling device in order to estimate the effect of the coupling device on the low frequency audio response.

The following rule of thumb comes in handy. If the audio response at 60 cycles per second is not to be less than 95% of the 400 c.p.s. response, then the inductance of the modulation choke or output transformer must not be less than .008 times the plate to filament resistance of the class C stage (the d.c. plate voltage divided by the d.c. plate current). For example: Suppose that our final class C amplifier draws 200 ma. at 1000 volts. That represents a load for the modulator of 5000 ohms. Thus 5000 times .008 equals 40 henrys, which is the lowest choke inductance or primary inductance allowable. If the class C load resistance reflected back into the modulator were 10,000 ohms, 80 henrys of inductance would be necessary. Few amateur stations need an audio response only 5% down at 60 cycles. In fact, as intelligibility is the main objective, little audio response below 150 cycles is necessary. Thus less than 40% of the inductance indicated above will allow a high degree of intelligibility to be maintained.

The high frequency response is often affected by the by-pass condensers used to keep r.f. out of the d.c. plate voltage leads to the class C stage. If the 5000 cycle audio response is to be kept up to 95% of the 400 cycle response, the by-pass capacity (in μfd s.) must be kept low.

Thus, a split stator tank condenser with the rotor grounded and with the d.c. plate voltage fed into the tank via a good r.f. choke connected to the center, or voltage node of the tank coil, will give materially better high frequency audio response than the use of a single section tank condenser and a large mica blocking condenser from the tank center tap to ground.

◆
Twelve years ago, the authorities listed as standard frequency stations those broadcasters whose frequencies did not deviate more than 2 kilocycles from the assigned figures!

◆
Buzzer-driven wavemeters were recommended for line-up oscillators in the first constructional articles on ham superhets.



The Cause, Effects, and Cure of Parasitics

By ED. HAYES* and K. V. KEELEY*

The usual r.f. amplifier has a tuned plate circuit and some kind of a tuned input circuit, both of which are tuned to the desired operating frequency. Spurious oscillations every now and then call our attention to the fact that it is very easy to make a circuit oscillate, and might be hard to stop it. The purpose of this article is to discuss briefly a few of the more common undesired oscillations and give a hint toward their eradication. It must be pointed out that every amplifier is a case of its own, and that there is no one cure-all which can be applied to all cases of parasitic oscillations.

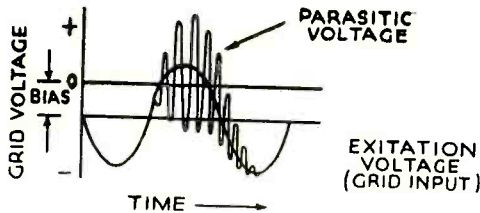

FIG 1

less negative, so that plate current flows, is to keep the bias constant and apply a voltage to the grid which is of the opposite potential to the bias. That is, apply a positive voltage in series with the bias. This occurs once on every cycle of excitation.

Figure 1 shows the varying potential of the grid with respect to time when being excited (solid line). During the interval that the grid potential is positive and near-positive with respect to the filament, plate current flows, and it is possible for oscillations to occur if the proper conditions are found in the grid and plate circuits. It is quite possible for an ultra-high frequency oscillation to start when plate current begins to flow, and for the high frequency oscillation to continue for several cycles during the period that the exciting voltage is positive, and then when the grid goes negative, for the oscillation to cease. It will then start up on the next positive cycle, etc. If the ultra-high frequency oscillation is very strong, it would be conceivable for the amplifier to oscillate all the time, instead of only on the positive halves of the excitation voltage.

It has been the writers' experience that fully 50% of the usual run of amateur transmitters have parasitic oscillations of one type or another present. The most common indication of these oscillations is lower efficiencies than the excitation, bias, and plate voltage would indicate should be the case.

Because the usual class "C" amplifier has high bias and excitation, it is often impossible to note any other evidence of parasitic oscillation than lowered plate efficiency. But if there is any doubt that the amplifier will oscillate at other frequencies, simply reduce the bias to lower than cut-off and apply no excitation, being careful to keep an eye on the tube. In a large percentage of the cases, oscillations can then be noted.

At this point some of you are probably saying, "Aha! But I don't operate my amplifier with low bias, so why should I worry about parasitic oscillations that don't occur unless the bias is reduced?" It must be remembered that the oscillations began as soon as the grid bias was reduced sufficiently to allow plate current to flow. Now another way to make the grid

Parasitic oscillations are usually thought of as occurring only at high frequencies, but they may also occur at frequencies much lower than the desired amplifier frequency. Spurious oscillations may also occur in audio amplifiers, because of the dynatron characteristics of certain

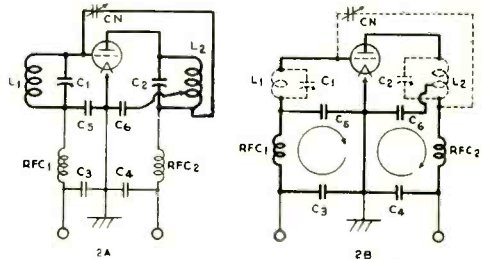

tubes. This discussion will be limited to oscillations occurring in r.f. amplifiers.

Low Frequency Oscillations

Parasitic oscillations may be divided into two groups, low frequency and high frequency; and the above groups may be divided into single-ended oscillations and push-pull oscillations.

*W6BC, Monrovia Road, El Monte, California.

Figure 2a is an innocent-looking neutralized amplifier that was encountered recently. The layout neutralized properly, but as soon as the plate voltage was applied it was impossible to get a plate current dip as the plate tank was tuned. Using a neon bulb, it was found that the whole plate tank was hot with no nodal ground point. (A wooden, or other insulating rod fastened to the neon bulb is a decided asset with high power.) The same was noted in the grid circuit. The excitation was removed and oscillations continued merrily on.

Figure 2b shows the unintended "sneak" circuits which were causing the amplifier to be a fine Armstrong oscillator. RFC1 and RFC2 were identical, as were C5 and C6. C3 and C4 are the filter condenser in bias and plate voltage supplies. RFC1 and RFC2 have become the plate and grid coils, with C3 and C5, and C6 and C4 the tank capacitors. At the low frequencies, L1 and L2 are but long leads and do not have any appreciable effect on the frequency. It will be noted that the neutralizing capacitor, Cn, is actually increasing the capacitance between grid and plate and causing the feedback to be even greater than if Cn were not present. In this type of oscillation, high r.f. current flows through the filter capacitor, often ruining the capacitor. To cure this type of oscillation it is simply necessary to detune either the plate or grid "sneak" circuit. This can be done by changing the value of RFC1, RFC2, C5, and C6. However, there is really no need of either RFC1 or RFC2 being used if C1 and C2 are large enough to by pass r.f. at the frequency at which the amplifier is to be operated. As a general thing, do not use an r.f. choke in series-fed circuits, or if you feel that you must, use chokes of different sizes in the plate and grid circuits.

High Frequency Oscillations

Using a high powered tube as a single-ended amplifier often results in high frequency para-

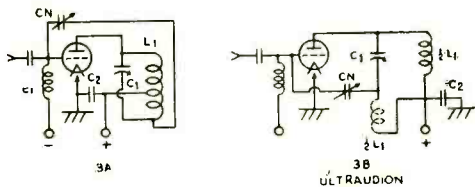

sitic oscillations. This can usually be traced to the long leads, physically large coils, and variable capacitors.

Figure 3a is a capacitive-fed neutralized am-

plifier, which turned out to be as shown in figure 3b, nothing more than our old friend the ultra-audion. The plate tank coil is acting as an r.f. choke at the frequencies at which oscillations are occurring. To see if this is the case, feed the plate power through an r.f. choke and completely remove the tank inductance.

The ultra audion type oscillation is a rather mean type to kill at times if the circuit illustrated is used. If a split-stator capacitor, with the rotor grounded, is used to tune the output circuit, the oscillations will usually be completely stopped, as the impedance between plate and ground will then be inversely proportional to frequency, and at high frequencies the plate will effectively be grounded. The same thing can be accomplished by using a tuned input circuit as then the grid becomes effectively grounded at the high frequencies.

Right now it should be pointed out that the old type absorption wave meter is extremely helpful in running down unwanted oscillations. Once the frequency of the oscillation is known, together with the type (push-pull or single-ended) one is well started on the cure of the spurious oscillations.

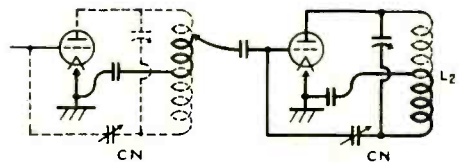

FIG 4

A trick which sometimes works is to put a resistor in the grid or plate circuit—preferably the grid. The losses occurring in the resistor will be proportional to the square of the current flowing through it. The r.f. grid current is proportional to frequency; hence the losses will be much greater at high frequencies, and often the losses will be sufficient to stop the spurious oscillation. The use of a non-inductive carbon resistor of 100 ohms or so has been incorporated in a number of linear amplifiers using high powered tubes, and has resulted in all signs of parasitic oscillations completely disappearing. The linearity of the amplifier, as checked by a cathode ray oscilloscope, was not affected by the use of the resistor and the power lost in them was insufficient to cause any noticeable heating. A warning: do not be too hopeful of the carbon rods as cures. More often than not a complete cure will not be effected, but they are worthy of trial on a stubborn case.

Another high frequency, single-ended oscil-

lation is shown in figure 4. Here the 2nd tube is acting as a t.p.t.g. oscillator as shown by the heavy lines. It is to be noted that the neutralizing capacitor C_n is actually furnishing feedback. If capacitive coupling must be used, the only remedy is to move the tap on L_1 up to the plate end of the coil and decrease the size of C_1 . Yes, it's a poor scheme, but so is capacitive coupling. The best bet is to have a tuned input circuit and use link coupling.

Using 852's in parallel occasionally results in a push-pull oscillation of extremely high frequency, in which the tank inductances are the leads connecting the grids and plates together. This oscillation may be detected by noting the point of low r.f. potential at the mid-point of the connecting leads. The remedy

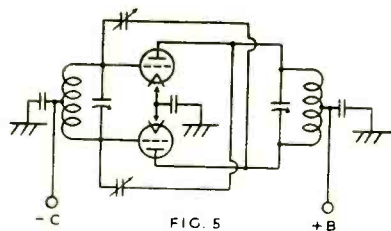

is quite simple: turn or move the tubes so that the leads are shorter. Another scheme which is just as effective is to make the wiring slightly unsymmetrical to the two tubes. It may even be necessary to put a small $\frac{1}{2}$ inch-diameter 2-4 turn choke in one of the plate or grid leads to one tube and not to the other.

Figure 5 is a push-pull amplifier in which parasites are especially apt to occur, the frequency being extremely high as determined by the length of grid and plate leads to the tank capacitor. The leads to the neutralizing capacitor are usually long enough for a phase shift to occur. The out-of-phase neutralizing voltage which is being coupled back to the grid isn't really out of phase with the plate voltage when it gets to the grid. The simplest remedy in the above case is to use in either the grid or plate circuit, a split-stator capacitor, with the rotor at ground r.f. potential, keeping the lead from the filaments to the rotor as short as possible. The capacitive reactance decreases as the frequency increases and the result is that at the frequency at which oscillations try to occur the grid or plate is grounded.

Figure 6 is the diagram of a class "B" linear amplifier which was recently worked upon, whose frequency range was from 3 Mc. to 15 Mc. The mechanical arrangement was such that

the leads from the grid tank to the grids were 9 inches, and the plate leads approximately twice that length.

When power was first applied to the amplifier, the plate current was 500 ma. or greater, *with no excitation!!* With the d.c. voltages which were applied to the grid, screen grid, and plate, the plate current should have been 200 ma., indicating that something was very much amiss. Touching the grids with a neon bulb indicated that oscillations were taking place. An absorption-type wavemeter was brought near the grids and it was found that the wave-length was around 7 meters. Shorting the plate and grid tank coils resulted in no change, indicating that the high frequency tank circuit consisted simply of the leads to the variable capacitors, the variable capacitors being effectively a short at these frequencies. Varying the tuning capacitor had practically no effect on the frequency or output.

A neon bulb touched to the screen grid by-pass capacitors showed that the screens were not at ground potential. These capacitors were attached directly to the socket with a lead of approximately 1 inch from the capacitor to the sub-panel shielding. No sign of r.f. could be found on the ground side of the capacitors. A number of various-sized by-pass capacitors rang-

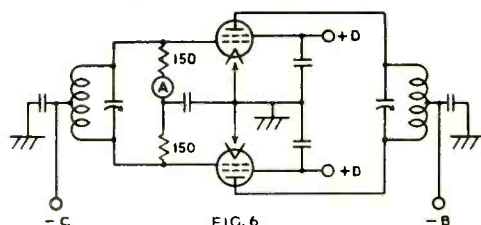

ing in size from .04 to .00005 μ fd. were tried. From .0005 up to .002 μ fd. the voltage on the screen grids decreased almost directly with capacitance. From .002 to .04 little difference was noted in the impedance of the capacitors at the parasitic frequency.

A number of different-sized parasitic chokes were tried in both the plate and grid leads. Chokes in the grid leads made the parasitics worse, while chokes in the plate circuit decreased the strength of the spurious oscillations. As the size of the chokes increased, it became harder to load the amplifier sufficiently. The use of 5-turn chokes 1 inch long and $\frac{3}{4}$ inch in diameter, resulted in oscillations occurring only when the grid tank capacity was set to less than half the maximum value. As the grid tank had been designed so that the over-lap in fre-



quency at each extremity of the band was approximately 5%, it was necessary that oscillations not occur at any setting of the tank capacity.

Carbon rods $\frac{1}{4}$ inch in diameter and approximately 25 ohms in resistance were tried both in grid and plate leads. When used in the plate leads, the parasitic oscillations were stopped but considerable power—around 15% of normal output—was lost in the heating of the carbon rods.

Combination of Carbon Rods and Chokes

Next the leads to the tank circuit were made of a carbon rod in parallel with small chokes

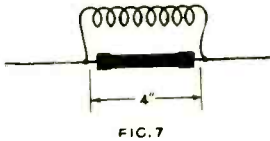

FIG. 7

(figure 7), the idea behind this being that the chokes would offer considerable impedance to high frequency spurious oscillations, and most of this current would go through the carbon rod, resulting in sufficient loss in power, or rather sufficient resistance in the high frequency tank, to kill the oscillations. At the lower desired frequency, the impedance of the chokes would be lower than the 25 ohm resistor and most of the low frequency current would go through the choke; accordingly the losses would be low.

This scheme proved to be a considerable improvement over anything previously tried, but the oscillations were so persistent that this failed to be completely satisfactory. If the resistance was high enough to kill the parasitic using a reasonable-sized choke, the power lost in the resistor at the operating frequency was too high to neglect.

By moving things around a bit, it was finally possible to shorten the leads to the grids by approximately 3 inches. This finally eliminated all parasitics.

The foregoing actual case was somewhat more stubborn than the average amateur situation. It gives, however, an idea of the routine to be followed in running down parasitics and preventing them.

Another point of attack is the all-important tank coil. Small diameter coils with the length no more than twice the diameter, wound with number 12 solid wire, have a "Q" just as high, and sometimes much higher than the more

bulky, older type copper-tubing. In addition to high Q, the field is much more concentrated, resulting in easier shielding and less coupling between adjacent circuits. When used in a neutralizing circuit, the small physical dimensions result in more nearly unity coupling between the two halves of the inductance, resulting in neutralization over a wider band of frequencies.

Some General Conclusions

Use link coupling whenever practical and if push-pull is employed, use split-stator capacitors in either the grid or plate circuit, preferably both. Avoid fancy wiring and the accompanying long leads, as many oscillations are t.p.t.g. and since there is usually a large condenser (physically) used in the plate circuit, it is a good policy to attempt to make the grid leaks just as short as possible, thus making the "sneak" grid circuit resonate at a considerably higher frequency than the plate circuit, and eliminating oscillations. Use *small diameter tank coils with a length no more than twice the diameter and wound of no. 12 solid wire.*

If the above precautions have been taken care of in the design, and oscillations are present when the amplifier is given its trial run, it is helpful to go about the elimination of spurious oscillations in a systematic manner. First determine the type and roughly the frequency. With this knowledge, it is simply a case of making the unwanted oscillating circuit a poor one, without impairing the performance of the amplifier at the operating frequency.

See if the leads cannot be made shorter, especially grid leads. Try resistors of the non-inductive type, together with resistors and small inductances in parallel. Keep notes of the steps taken and the effect. It is mighty hard to come back the next evening or the next week and remember just what has been done. Thousands of rigs are in operation free of parasitics and there is no reason why every lay-out can't be without them.

Japanese motorists are urged to "tootle their horns melodiously and cry *hi, hi* to jaywalkers." (Nope, Scratchi didn't give us this one; it's straight stuff.)

The W.P.A. lists four projects in various sections of the country for the construction and improvement of radio stations. Radio technicians are also employed by the W.P.A. on numerous other projects classified as "educational".



F.C.C. Power Ratings of Common Tubes

The approved F.C.C. power ratings of vacuum tubes for operation in the last radio stage of broadcast transmitters are fixed as set out in the following tables:

TABLE A¹

Power Rating of Vacuum Tubes for High-Level Modulation or Plate Modulation in the Last Radio Stage

Power Rating (watts)	Amperex	Collins	De Forest	Eitel McCullough	Federal Telegraph	Heintz & Kaufman	Hygrade Sylvania	RCA Mfg. Co.	United Electronics	Western Electric
50				50-T						211-D 211-E 248-A 276-A
75	HF-100 203-A 211 838 852 860	C-203A C-211	503-A 511 552 560		F-303-A F-311-A F-352-A		203-A 211 852 860	203-A 211 838 850 852 860	303-A 311 361-A 938 952	242-A 242-B 242-C 260-A 261-A 284-A 295-A
100					F-102-A F-108-A					
125	HF-200 203-H 211-C 211-D 211-H 805	C-200 C-201 C-211D		150-T				803 805	905	
250	204-A HF-300	C-204A C-300	504-A 561 571		F-204-A F-212-E F-331-A	354	204-A 212-D 831 861	204-A 831 861	304-A 312-E	212-D 212-E
350	849		549	300-T	F-100-A F-349-A		849	849	949	270-A
500						255				251-A
750	851		551	500-T	F-351-A		851	851	951	279-A
1000					F-346-A	1554	846	846		
2500			520-B 520-M		F-328-A F-3652-A	3054	820-B	1652		228-A
5000			507 548 563		F-307-A F-320-A F-320-B F-348-A F-363-A		207 848 863	207 848 863 891 892		220-B
10,000					F-101-B F-110-A F-110-X F-116-A F-332-A F-332-B F-332-C F-358-A			858		232-A 232-B
40,000								862		298-A

¹These tables apply only to tube ratings for use in the last radio stage of broadcast transmitters and may not be applicable to any other service.



TABLE B¹

Power Rating of Vacuum Tubes for Low-Level Modulation or Last Radio Stage Operating as Linear Power Amplifier

Power Rating (watts)	Amperex	Collins	De Forest	Eitel McCullough	Federal Telegraph	Heintz & Kaufman	Hygrade Sylvania	RCA Mfg. Co.	United Electronics	Western Electric
25								203-A		
50	HF-200 203-H 211-H			150-T		354		803		242-B 242-C
75	HF-300 212-E		504-A		F-304-A F-312-A		204-A 212-D	204-A	304-A 312-E	212-D 212-E
125			549	300-T	F-100-A F-349-A		849	849	949	270-A
250			551	500-T	F-351-A	255 1554	851	851	951	251-A
500					F-346-A	3054	846	846		279-A
1000			520-B 520-M		F-328-A F-3652-A		820-B	1652		228-A
2500			507 569		F-307-A F-320-A F-320-B F-363-A		207 863	207 863 892		220-B
5000					F-358-A			858		
8500					F-101-B F-110-A F-110-X F-116-A F-332-A F-332-B F-332-C					232-A 232-B
25,000								862 898		298-A

TABLE C¹

Power Rating of Vacuum Tubes for Grid Bias Modulation in the Last Radio Stage

Power Rating (watts)	Amperex	Collins	De Forest	Eitel McCullough	Federal Telegraph	Heintz & Kaufman	Hygrade Sylvania	RCA Mfg. Co.	United Electronics	Western Electric
50						354				212-E 270-A
100				300-T						
125				500-T		255				
250						1554				
500						3054				
2500					F-307-A					

If in an application to the Commission a vacuum tube of a type number and power rating not given in the foregoing tables is specified for operation in the last radio stage, it may be accepted provided there is also submitted to and approved by the Commission the manufacturer's rating of the vacuum tube for the system of modulation or class of service contemplated. These data must be supplied by the manufacturer.



Modulation Power Data

The accompanying curve is a picture of the workings of the ordinary formulas as to audio power required for *plate* modulation. It is also useful for other sorts of modulation, except the

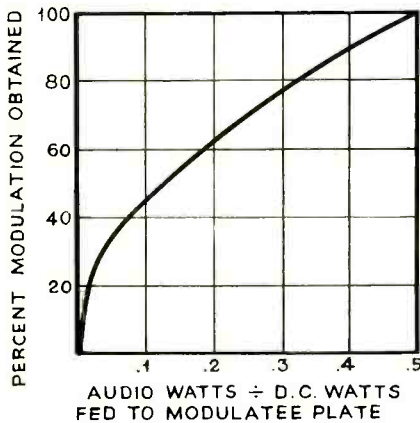

Figure 1

"Phelps" type of grid modulation, in which the modulatee (tube which is being modulated) is worked without any grid current.

Plate Modulation

For 100% plate modulation without "carrier control" we usually say that the audio power must be 50% as great as the d.c. power which is flowing into the "modulatee" plate at times of zero modulation. Putting it differently, if the "modulatee" were drawing 100 d.c. watts (when not modulating) we are supposed to require 50 audio watts for 100% modulation *with a pure steady tone*. We do *not* require as much as 50 audio watts for most sorts of tones but fortunately an audio system able to deliver 50 pure-tone watts will also be about right for the job with other wave-forms.

70% Modulation

It is interesting to note on the curve that for 80% modulation we need only $\frac{2}{3}$ as much power as for 100% modulation. For 70% modulation we need only $\frac{1}{2}$ as much audio power as for 100% modulation.

If by dropping from 100% modulation to 80% modulation we wipe out the overmodulation distortions, get almost as good a signal and save audio power there is something to be said for the change.

Of course, the average amateur will prefer to go the other way—keep the audio power the

same and raise the modulatee input 50% and thereby raise the carrier watts, the distant signal (not carrier) remaining *about the same* but with lessened distortion. If a class B audio system is used another interesting factor enters. Provided such a system has adequate transformers—really good ones—and also provided the driver stage is ample, the audio harmonic distortion at 150% of the data-book rating is no worse than that of the ordinary broadcast-receiver pentode at 100% rating. For a pair of 46 tubes under good conditions the measured performance was as in figure 2, for a plate voltage of 300, for which the tubes are rated at 16 watts output.

Let's follow this 46 case along as an example.

(1) Working in the usual way one would use this audio system to modulate 32 d.c. watts of modulatee input 100%.

(2) Or it may be used to put 80% modulation on 48 d.c. modulatee input watts. Finally we may run the audio gain up a ways and

(3) with 2% more audio distortion put 100% modulation on the 48 d.c. watts.

In voice work the average level is *far* below the peaks, which are the strongly-accented syllables. Consequently we could adjust for condition 3, yet spend *almost all* of our talking-time well to the left of the dashed line, which is the maker's tube rating.

This sounds like an argument for over-running class B tubes, but the over-rating operation is for brief spurts and harmless if the tube has a good filament.

Since the modulation transformer was probably designed to load the 46 tubes normally when "looking into" a modulatee plate which is drawing 32 watts it may not provide the proper secondary taps to give a proper load to the 46 tubes if the modulatee plate current is increased without a change of modulatee plate voltage. To this transformer the modulatee plate circuit "looks like" a resistor. The value of this resistor is:

$$\text{Ohms} = \frac{\text{Modulatee volts}}{\text{Modulatee amperes}}$$

Note that amperes, not milliamperes, are considered and that this is a "carrier" or unmodulated condition.

Other Tubes

Of course, other class B tubes follow much the same argument. For class A or A prime the limits are more definite and one lacks enthusiasm about the idea of "spurt" over-running. It isn't a new idea, of course, to "kick up" class B output; it's being done every day (with modulation being kicked up above 100% at the same time). The idea here is merely to aim at 100% on only the high peaks, but instead of doing this by holding the a.f. down to use enough carrier so that 100% of

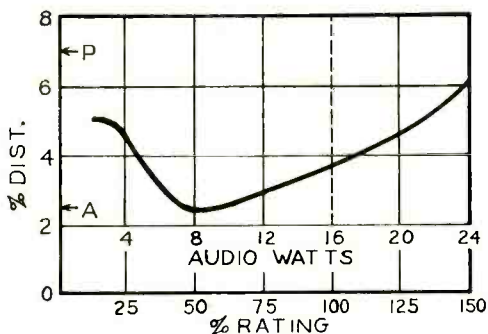

Figure 2

modulation means 150% rated audio output for the class B tubes.

Other modulation schemes (screen, screen-plus-plate, grid modulation with grid current) all take power from the audio system and the same general lines of reasoning apply *except* that the data at the bottom of the percent-modulation curve (both figures and words) must be suitably adjusted. If the wording is erased and the figures are multiplied by 2 we can read them as "Fraction of the full-modulation audio power."

HOW HIGH IS "UP"?

The way to get out of noise for reception is to go up, and the way to get out of screening and absorption for sending is also to go up. Here are some illustrations:

At a certain radio factory a horizontal receiving doublet gave pretty poor results when hung between the cornices of two adjacent factory bays. The noise was gosh-awful. The thing was 80 feet off the ground but swiveling it hither and yonder did no good; even in a screened room the receiver was all full of noise. Then an old-line radio man who remembered that we used to use poles that went a little higher than the blue grass stuck two 30 foot poles upon the roof and the noise dropped

about 95%. Not, mind you, because the height above ground was raised from 80 to 110 feet, which after all is only about 37% increase. It was because the distance above the wiring was increased from about 5 feet to about 35 feet, which is an increase of 600%.

Again, a sending station in Kansas got out very poorly with an antenna hung from the maple trees. The trees were 65 feet high and the antenna consequently about 50 feet up above Kansas—but 15 feet *down* among the trees. Two poles were put up, 70 footers. There was no guying space for higher ones, alas. Experiment showed that the range was about the same with the antenna at 30, 40, 50, and 55 feet up—but jumped enormously when the antenna was sent clear up, which of course meant only about 65 feet on 70 foot poles. The antenna height above Kansas had been increased from 50 to 65 feet, about 30%. The height advantage of the trees had been cut down from 15 feet to 0 feet, which is something like 10,000,000% as nearly as you can figure on a slide rule. Anyway the fairly consistent 80 meter range increased from 10 miles in daylight to 180, which is an increase of 1700%. Now if the boss of the works can only figure out how to make those poles go up to 90 or 100 feet without getting into an argument with either dad or the neighbors!

Still once more: Two stations in a certain Connecticut town have been outstanding in the history of that town for the ranges attained with good consistency—and who cares about once-in-a-while ranges? One of these stations had a single 202 tube (an old one at that), but the antenna went almost vertically to the top of a 13-story building. The thing worked on the umph harmonic. Nobody ever bothered to figure out what the length was, or which harmonic was used. What difference did it make when you could work anyone that could be heard? The other station stood in a place that had a yard about 25 feet square. By defying the laws of physics an 85 foot mast was stuck up—yes, this was in the days of antennas 45 feet high. By test every single 10-foot rise above 25 feet gave an increase in the *consistent* range, though the freak ranges remained about the same. The antenna was sent up by stages several times, dozens of observers were used, and none were told what was going on.

The old-fashioned idea that a radio station needs poles or masts is still a mighty good one—and what a lot cheaper than a kilowatt!

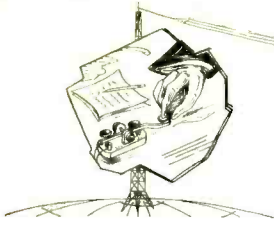

CALLS HEARD AND DX DEPARTMENTS



Numeral suffix indicates "R" strength. Send Calls Heard to Calls Heard Editor*, not to Los Angeles.

R. D. Everard, 5 Flint Cottage, Church Walk, Forbury, Sawbridgeworth, Herts, England.
May 1 to October 17

(14 Mc. phone)

W 5ACF; 5AHD; 5AHK; 5AII; 5AKZ; 5ASG; 5APW; 5ATB; 5AWU; 5AXA; 5BAT; 5BDB; 5BEE; 5BEQ; 5BFS; 5BGT; 5BGW; 5BIN; 5BVH; 5CCB; 5CFK; 5CO; 5CTC; 5CVJ; 5DCP; 5DDP; 5DLP; 5DNV; 5DOB; 5DUK; 5DUK; 5DVR; 5DVM; 5EBP; 5ECT; 5EDO; 5EEH; 5EGF; 5EPW; 5EQI; 5ETR; 5EUC; 5EWD; 5EXL; 5FDI; 5FFA; 5FJ; 5FNA; 5HR; 5JC; 5LD; 5LM; 5MS; 5NT; 5OX; 5PP; 5Q; 5SF; 5SH; 5UN; 5ZA; 5ZS; 6ABF; 6ABR; 6AH; 6AM; 6ANU; 6AQK; 6AVU; 6BAY; 6BCA; 6BCF; 6BGH; 6BHO; 6BJI; 6BKY; 6BOS; 6BUQ; 6BUY; 6BYW; 6CFJ; 6CIF; 6CIN; 6CKR; 6CLS; 6CNE; 6CQG; 6CZ; 6DEP; 6DMN; 6DAT; 6DTE; 6DWE; 6DXY; 6DYH; 6EAN; 6EBJ; 6EIP; 6EJC; 6ELR; 6EQA; 6ERT; 6ESX; 6EZO; 6FFN; 6FOY; 6FTU; 6FYJ; 6GAL; 6GAT; 6GNP; 6GOY; 6GYO; 6GZU; 6HAA; 6HAR; 6HCQ; 6HEG; 6HEW; 6HKV; 6IRX; 6ISH; 6ITH; 6IXJ; 6JPW; 6JZE; 6JZH; 6KM; 6KMO; 6KSE; 6KSO; 6KW; 6LDB; 6LFQ; 6LFU; 6LHF; 6LIP; 6LKR; 6LLQ; 6LLU; 6LR; 6LY; 6MBE; 6MVR; 6MXD; 6MXW; 6MYO; 6NIT; 6NIX; 6NNR; 6NRX; 6NJ; 6YU; 7ALZ; 7AMQ; 7APD; 7AO; 7AQO; 7AWY; 7BCI; 7BME; 7BQV; 7BUH; 7CHT; 7DNB; 7DNP; 7DXT; 7EAF; 7EBK; 7EGV; 7EPU; 7ETN; 7EXK; 7FL; 7FP; 7IF; 7MD; 7QC; 7VA; 7VS; 7WL — CE1DC; CE1AR; CE3AG; CE3DW. — CO 2AU; 2HY; 2JM; 2KL; 2KY; 2LL; 2QQ; 2RA; 2SG; 2SV; 2WW; 2WZ; 5RY; 5OM; 7CX; 7HF; 8EC; 8RQ; 8VZ; 8VB. — CP1GB; HH2B; HH5PA; HK1ADM; HK1Z; HK2RS; HPIANY; HP2AE. — K 4DDH; 6BAZ; 6CMC; 6JLV; 6KKP; 6LBJ. — KA1BH. — LU 1EX; 4BC; 4BH; 4BL; 5CZ; 5DQ; 6AP; 6KE; 8AD; 8DR. — OA4AA; OA4AG; OA4AK; OA4B; OA4R. — PY 1CK; 1DJ; 1DW 1EQ; 2AK; 2BA; 2BD; 2BF; 2CK; 2CN; 2EJ; 7AA; 7BB. — PK 1MX; 1QU; 1ZZ; 3ST; 4AU; 4VR. — SU1SG; SU1KG; SU1RO; SU8MA; TI2AV; TI2DC; TI2FG; TI2LR; TI3AV; TI5J. — VE 4AW; 4BF; 4CW; 4DU; 4FD; 4FI; 4GD; 4GU; 4GL; 4HQ; 4HW; 4KX; 4LA; 4LX; 4MO; 4MY; 4NM; 4OF; 4SW; 4YX; 5BY; 5CL; 5DK; 5EF; 5EH; 5ES; 5HI; 5HU; 5JB; 5JK; 5OT. — VK 2AP; 2BG; 2BW; 2HF; 2HS; 2IQ; 2JA; 2JZ; 2JU; 2NY; 2NO; 2QR; 2RH; 2RB; 2TC; 2TI; 2UC; 2UD; 2VA; 2XS; 2YW; 3MR; 3KX; 3OC. — VP 2CD; 3DG; 4TH; 5IS; 6AS; 6FO; 6YB; 9R. — XE 1CS; 1G; 1HH; 2AH; 2HF; 2N; 3AG; 3W. — ZS1C.

(3.9 Mc. phone)

W 1ADM; 1AJZ; 1FCE; 2BDT; 2CQV; 2ZC; 3FJU; 3IS. — VE1BO; VE1CR; VE1EI; VE1IN; XE1G.

(28 Mc. phone)

W-1ADR; 1AUC; 1CCZ; 3NK; 8IJZ.

J. A. Philpot, 21 Casino Avenue, Herne Hill, S. E. 24, London, England

Calls Heard at Eastbourne, England

(14 Mc. c.w.)

W. 5AFX.3; 5EIP.5; 5FNY.5; 6CU4.4; 6CXW.3; 6DRE.2; 6GRL.4; 6KRI.3. — CPlAA.6; CX1BG.4; CX1FB.4; F88AB.6; F88AD.6; HK3AJB.4; J5CC.6; K4DTH.4; K5AG.6; LUSBZ.5; LU7AZ.6; LU9AX.4; ON4CJ.4; NY2AE.5; PK1PK.4; PY1AW.4; PY1BR.5; PY2BZ.4; SU1FA.6; SU1KG.5; SU1SG.8. — VK 2AS.5; 2DA.5; 2HI.6; 2LW.5; 2LZ.5; 2NY.4; 2PX.6; 2XJ.3; 2XU.5; 2YL.6; 3CP.5; 3CZ.6; 3GU.5; 3KK.5; 3KX.4; 3MR.5; 3TU.3; 4EI.4; 4EL.4; 5KL.4; 5WK.3; 7KV.6. — VP2AT.5; VQ9FAR.7; VQ4KSL.7; VU2AU.5; VU2EP.4; XE1AK.5; ZE1JS.5; ZL3DJ.6.

(14 Mc. phone)

PK4AU.6; PY2BA.5; VU2CQ.6.

(7 Mc. c.w.)

CM6RC.6; K5AM.7; NY2AB.7; W5FOA.4; XE1BC.5.

Peter Jastremskas, Hipodromo 14, Kaunas, Lithuania

(14 Mc. c.w.)

W 1ALW.4; 1AYX.7; 1CGM.6; 1GCO.5; 1GNE.5; 1IKB.4; 1IYJ.5; 2AL.5; 2AMA.4; 2AXZ.6; 2CYS.6; 2DLO.4; 2EEN.6; 2GJW.5; 2GLD.6; 2GTP.4; 2HWG.5; 2HXB.5; 2JPZ.6; 3AGC.5; 3EJM.5; 3FOB.4; 3HC.3; 4BNR.5; 4BWZ.6; 4CUO.4;

4DAY.4; 5AIR.5; 5AOS.4; 5SPB.4; 5CQO.4; 5ECU.6; 5EHM.5; 5EMG.4; 5EUG.3; 5FIY.4; 5QL.5; 6BAX.5; 6CFM.5; 6CSI.4; 6CXW.5; 6DLN.4; 6DQV.4; 6DTB.6; 6DZE.4; 6EJC.6; 6FHE.5; 6FKZ.5; 6FZY.6; 6GAX.5; 6GRX.6; 6HTL.5; 6HX.4; 6IJR.5; 6IKB.4; 6INP.4; 6IOB.4; 6IOJ.5; 6IOU.6; 6IOY.4; 6KNF.5; 6KWC.4; 6LDJ.6; 6LFC.6; 6LEE.5; 6LFL.5; 6MTC.5; 6ZS.4; 7BLT.6; 7EKA.5; 8BJG.5; 8DFH.5; 8DQV.4; 8ETT.4; 8HGA.4; 8KTV.4; 8NVY.7; 8ONR.4; 9ABE.5; 9AFO.6; 9BDX.5; 9DEF.4; 9DHT.4; 9DNP.6; 9DXX.7; 9ELA.5; 9FYV.6; 9GHN.6; 9HRL.6; 9IC0.4; 9IJ.4; 9KG.7; 9IBB.6; 9LM.5; 9MKZ.5; 9OKZ.5; 9PJN.4; 9RCQ.4; 9RKP.4; 9SJV.4; 9SMW.5; 9TJ.4; 9TSV.4; 9VNW.5. — CR7GC.5; CT2BG.5; CX1BG.5. — J 2II.4; 2MI.5; 3CR.5; 3FK.4; 3GG.4; 4CT.5; 8CA.4; 8CD.5. — K5AG.5; K5AY.5; LU1CA.6; LU6JB.5; OA4A.4; ON4CJ.5; ON4CSL.5; PK1BK.4; PK1PK.6; PK2K0.7; PY2GJ.4; PY2CW.3; PY2QV.6; SU1FS.6; SU1RO.4; SU1TM.3; U9AZ.6; VE2HF.4; VE4JY.6; VE4NM.6; VE4OG.6; VE4UX.6; VE4VI.4. — VK 2JZ.5; 2KS.4; 2OJ.4; 2OP.4; 2OW.5; 3CX.6; 3DQ.4; 3HK.5; 4LW.4. — V11X.4; VP2BX.6; VQ4SNB.5; XE1AA.5; XU3ST.3; XU8MT.5; ZE1JA.4; ZL2FA.4; ZL2KB.3; KL4FK.5; ZTZC.4.

A. E. Lower, XU3XA-XU8XA, Chinwangtao, North China. (Near Peking) Permanent mail
QRA : U.S.S. Augusta, via San Francisco, Calif.

W 6AJN.5; 6BVX.4; 6COF.4; 6FZL.5; 6IRR.3; 6JWT.4; 6NGO.5; 6NZL.3; 7FBG.4; 7MB.5. — J3CR.5; J3CX.5; K6AKP.5; K6MEM.5; KA1EL.5; LU2AM.5; LU7AZ.5; LU9BV.5; VK2KS.5; VK2NO.3; VK2WC.5; VK3ML.4; VK3NG.5; VK3SN.5; VK4BB.5; ZL2QM.5; ZL3KG.

Leonard T. Robinson, 822 1/2 West 42nd Place, Los Angeles, Calif.

(14 Mc. c.w.)

CR7AD; CR7GC; CR7Z; F88AB; PK1BX; PK1LW; PK1JW; PK2BK; PK4RK; VU2BJ; VU2LJ; VS1AB; VS1AL; VS2AG; XU3GK; XU3ST; XU3EA; XH8RL; ZE1JG; ZE1JM; ZE1JN; ZE1JS; ZS1AL; ZS1AX; XS1D; ZS2N; ZU1C; ZT2Z; XS4U; ZS5Z; ZU6B; ZUGAG; ZUGAF; ZUGAK; ZUGAQ; ZS6T.

L. P. Flavin, W9SIV, 3925 Lincoln Ave., Chicago, Ill.

To September 8

(14 Mc. phone)

CO2XF.7; HI5X.8; HI7G.5; NY2AE.9; VO1I.7; VP6YB.8; XE1G.7; VP7NA.7.

(14 Mc. c.w.)

CM2AI; CM2BG; CM2XF; CM7AB; CM8MC; CX1CC; D3CFH; D4ARR; D4TKR; D4XCX; F2A; F3BF; F8KP; F8NR; F8WK; F88AB. — G 2AO; 2AV; 2IO; 2OF; 2PL; 2ZQ; 5VU; 5WJ; 6NG; 6PY; 6QX; 6VP; 6WR; 6WY; 6XL. — HAF8D; K5AA; K5AC; K5AG; K5AH; K5AM; K5AY; K7ENA; K7FRU; LU6AD; LU6LG; NY1AA; OA4C; OA4I; OE1ER; OE7EL; OH3OI; OH5NR; OK2RM; ON4AU; OZ7SB; PAOXG; PK1HX; PK1PJ; PY2AR; PY2DN; PY2GJ; PY5OD; PY6AQ; SM50Q; U1BL; U2NE; VK3FM; VK2XJ; VK5FM; VK5SG; VK6CA; VP7NA; XE1AK; XE1AX; XE1CM; XE1DA; XE1DD; XE1H; XE2CQ; XE2V; XE3AR; YM4AA; ZL2CD; ZL2GO; ZL3RR; ZL4AC.

Donald W. Morgan, BRS 1338, 15, Grange Road, Kenton, Middlesex, England

June 1 to July 4

(14 Mc. phone)

W 1AF.7; 1AXA.7; 1BSN.8; 1CCZ.7; 1CTZ.7; 1DMV.7; 1FLH.8; 1GED.7; 1GID.7; 1IFD.7; 1ISD.8; 2AJ.7; 2BSD.8; 2CLS.7; 2ECR.7; 2ELO.7; 2EOY.8; 2EUG.7; 2EUT.7; 2FWK.8; 2GNT.7; 2HVQ.7; 2JQA.7; 2MJ.7; 2XC.7; 3CAG.7; 3CC.7; 3CQS.7; 3CKT.7; 3CZE.7; 3DPC.7; 3DRA.7; 3MD.7; 3OX.7; 3PC.8; 4AKY.6; 4ASE.7; 4ASK.6; 4DLN.7; 4DAY.7; 4DYT.6; 4OC.7; 4UP.7; 5CXQ.6; 5EWD.7; 5LD.6; 8DIA.7; 8HEQ.7; 8JNU.7; 8LQI.7; 8MQX.7; 8NE.7; 8PHB.7; 8TC.7; 9BTR.6; 9IEW.7; 9KGS.7. — CE3AG.7; CO2AN.7; CO2WZ.7; CO7CX.7; CO8YB.7; CT1BG.7; CT2AB.7; CX1AA.7. — EA 2BH.8; 3BA.7; 3BL.8; 3CY.7; 3DY.7; 3BE.7; 7BA. — F8DK.7; F8II.8; F8NG.8; F8MG.7; HI1C.7; HI5X.7; HI7G.7; HI7K.7; LA1G.8; LU1DA.7; LU1EX.7; LU6AP.6; LU8AB.7; LY1AK.7;

*George Walker, Assistant Editor of RADIO, Box 355, Winston-Salem, N.C., U.S.A.



0E6MP-7; 0N4DM-7; PY1EQ-7; PY2BA-7; PY2CK-7; PY2EJ-7; SM5SX-8; SM5TC-7; SU1R0-7; TI2RC-6 — VE 1AQ 8; 1AW-7; 1BA-7; 1BR-7; 1CN-8; 1CR-8; 1DQ-7; 1DT-7; 2BE-7; 2CA-7; 2VF-6; 9AL-7 — VK2BQ-6; VK4WX-6; V01I-7; V01J-7; V04Y-6; VP2CD-7; VP6YB-7; VP9G-6.

Joseph B. Tomczyk, W9DBC, 312 14th Avenue N.E., Minneapolis, Minn.

(14 Mc.)

CE1A0; CM8AE; CX1CC; CX1CX; D4ARR; D4YDF; D4YJ1; E18B; E19G; F8AB; F8RC; F88AB; F88AD; G6NJ; G6PY; G6X1; HC2JM; HC2MO; HK3JB. — J 2CB; 2CC; 2CL; 2HQ; 2JJ; 2LU; 3CR; 3FI; 3FJ; 3FK; 5CC; 5CE. — LU1EP; LU4BH; LU6AD; LU7AZ; LY1J; OA4J; OH3NP; OH5NF; PK1PK; PK3BM; SP1DC; SM7UC; TI2FG; TI2FT; U2NE. — VK 2AS; 2ABC; 2BR; 2BQ; 2CN; 2DA; 2DG; 2HT; TJX; 2LZ; 2QO; 2OW; 2PW; 2QE; 2QK; 2QM; 2UU; 2RK; 2SK; 2TD; 2TE; 2TQ; 2VA; 2VN; 2XJ; 2XT; 2YF; 2YL; 2ZJ; 2ZZ; 3EG; 3EM; 3EO; 3DM; 3HG; 3LA; 3KX; 3MK; 3MR; 3OC; 3RJ; 4A0; 4AP; 4BB; 4ER; 4GK; 4HR; 4LW; 4UR; 5A1; 5BY; 5GR; 5HG; 5HL; 5HW; 5MD; 5MY; 5WR; 5XA; 5XJ; 6CA; 6CP; 6KB; 7KV. — VP7RC; XE3AR; YM4AA; YN1AA; YV5AP; ZE1US; CD; ZL2FX; ZL2G0; ZL1DS; ZL1DV; ZL1FE; ZL1HI; ZL2 X; XS5Z; ZS6T; ZU1T; ZL2II; ZL2GR; ZL4A0; ZS1AL; ZS1A ZUGAL.

Julian Matbis, W3DMQ, 4310 Ludlow Street, Philadelphia, Pa.

(14 Mc. c.w.)

CM2BG; CM2D0; CM2OP; CM2RM; CM7AB; CM7A1; CM8MC; CP1AA; CP3ANE. — D 3BQP; 3CFH; 3CSC; 3CUR; 3DBN; 3FZ1; 3GKR; 4ARR; 4B0N; 4BQ0; 4CDM; 4DLC; 4GAD; 4GLF; 4JH; 4KR; 4NPR; 4NVR; 4QET; 4QNM; 4QWJ; 4SPP; 4TKP; 4TPJ; 4XCG; 4XQF; 4YBF; 4YJ1. — EA4BM; E15F; E18B; E18G; E19G; ESSC. — F 3AU; 3EB; 3KR; 8IZ; 8LG; 8NV; 8NY; 8QQ; 8RC; 8RJ; 8WK; 8WQ; 8GK. — FB8AB; FMSAD; FT4AG. — G 2AV; 2BK; 2CL; 2IM; 2LU; 2PL; 2RF; 2TM; 2UL; 2ZY; 5CW; 5GL; 5GQ; 5HB; 5KJ; 5PP; 5RX; 5SR; 5PD; 5YV; 5VB; 6CJ; 6DT; 6GH; 6IR; 6LM; 6MK; 6NJ; 6WI; 6QX; 6RB; 6RH; 6TD; 6TR; 6TZ; 6UW; 6VP; 6VV; 6WY; 6YU; 6ZS; 6ZU. — G15QX; G16XS; HAF5G; HB9AC; HB9B; HB9BD; H93L; HK3JB; I11R; I11RA; I1TKM; J2LC; J5CC. — K 4DTH; 5AA; 5AC; 5AF; 5AG; 5AH; 5A1; 5AL; 6BAX; 6LEJ; 6NCW. — LA2X; OK1ZB; OK2MA; ON4CD; ON4CJJ; ON4CN; ON4DX; ON4GW; ON4ZTW; OZ2B; OZ7G. — PAO gn; JMW; KG; LR; MDW; NW; PN; QG; GL; XF; DK. — PY 2BU; 2D0; 2CK; 2EA; 2QG; 8AD. — SM5UW; SM7YN; SP1FP; SP1JB; SU1SG; SU5AK; TI3WD; U2NE; U3AG. — VK 2AS; 2CG; 2FY; 2JX; 2LR; 2LZ; 2RK; 2UD; 2QO; 2XU; 3BJ; 3BW; 3DM; 3EO; 3GP; 3KJ; 3KX; 3MR; 4AP; 4GK; 5JB; 5WP; 6MW; 7NC. — XE1AK; XE1L; XE1S; XE2N; YM4AA; YN1AA; ZL1FE; ZL2II; ZL3DJ; ZL3FZ; ZL4A0; ZL4BQ; ZS10; ZS6AL; ZU1T.

Vincent McMinn, NZ16W, 12 Edge Hill, Wellington, C-3, New Zealand

June 1 to July 1

(7 Mc. c.w.)

CM8AA-6; CT1GG-4; CT1MS-5; CT1LZ-7; D4ZMI-6; EA1AT-5; EA3A0-6; EA3EE-6; EA4BD-7; EA5AQ-5; EA5CG-6; F3EY-6; F3HR-5; F8AT-5; F8JD-5; F8JF-5; F8KS-5; F8YZ-5; G2AV-5; G2AW-6; G2NA-6; G5JN-5; G6DXP-4; G6JW-6; G6T0-4; HB9BD-5; HB9BL-6; HJ5AK-6; I1EC-4; K5AM-6; LU2CW-8; ON4DM-5; ON4MA-5; OZ8B-5; SP1FF-4; SP1FU-5; SP1IA-5; SP1IF-5; SP1IH-6; U2AG-5; U2NE-5; U40L-5; U2NE-5; U40L-5; U5AH-6; XE1HG-5; YR5ST-5; YU70R-6.

(14 Mc. phone)

W 11FD-7; 1PL-6; 2AKK-6; 2EUG-7 2FOA; 3EYH-8; 4LL-6; 5BEE-7; 6EQA-6; 7APD-6; 8ANO-7; 8FHW-6; 8LIJ-8; 9NA-6; 9RGB-5. — C02KC-6; C08YB-6; EA4BM-6; EA7A1-8; H1LW-5; H17G-6; K6KDX-5; NY2AE-7; OA4AK-6; ON4VK-6; PY2BA-6; TI1AF-7; VE2HM-6; VE2MC-6; VE5KY-7; VE5OT-6; XE2AH-9.

(14 Mc. c.w.)

CM2AZ-5; CM2FM-5; CM2CP-5; CM8GF-5; CM8MC-5; CM8RQ-6; CT1KR-5; CT1ZZ-5; CX1BG-5; CX2AK-5; D3DXU-5; D4ARR-6; D4HCF-6; D4SXR-5; D4TKP-6; D4VRR-6; D4XVG-5; EA2AD-5; EA3BV-5; EA3EG-5; EA4Z-5; EA4AP-6; EA4BM-6; EA5BS-5; F 8BF-5; 8DC-5; 8DW-5; 8EB-5; 8EF-5; 8FC-5; 8KJ-5; 8LG-4; 8LX-6; 8NE-6; 8NV-5; 8RC-5. — FT4AG-6; G2IM-5; G2ZQ-5; HAF2I-4; HAF3D-5; HAF6G-5; HB9AK-5; HB9AW-4; HB9AZ-4; HB9BD-6; I1DL-4; I1RR-5; I1TKM-5; J8CF-6; LU3DH-6; LU5AN-7; LU5BZ-7; LY1J-5; OE3EZ-5; OE7JH-6; OK1FD-6; OK2HX-7; OK2LU-5; OK2PN-6; ON4GW-6; ON4FC-5; ON4HC-5; ON4HM-6; ON4RAY-5; ON4TF-5; PY2BB-5; PY2DC-5; PY2CW-4; PY2QD-7; SP1FU-5; SU1KG-6;

U2NE-6; U3D1-5; VE2CA-6; XE1AY-7; XE1BT-6; XE1FL-6; XE1R-6; XE3R-6; YR5OR-6; YT7KP-5; YT7VN-5.

To June 1

(7 Mc. c.w.)

CT1MH; CT1MR; CT1RO; D4SDA; D4TJP; D4XFB; D4YJ1. — EA 2BU; 3BM; 3BP; 3EG; 4BM; 5AQ; 5CK; 6AF; 8AE; 8AF; 8AH; F 3A1; 3AU; 8FK; 8FX; 8NE; 8PK; 8ZZ. — FB8AD; HAF2G; HB9AQ; HB9BE; J2CT; J2MU; J4CP; J6DS; KALPT; LA2B-6; OA4AB; OE3AH; OE7JH; OK1ZB; OK2OP; OK3DC; ON4BD; ON4DM; ON4FE; ON4NC; OZ8B; PAOCF; PAOCV; PK3LC; SM7UC; SP1AL; SP1AR; SP1KM; U3BN; U3VB; U40J; U5RC; U9AY; UK1AA; UOCQ; VQ8AD; VQ8AG; YR5IG.

(7 Mc. phone)

EA5BF-6; EA5BL-6; TI2FG-6; OA4R-8.

(14 Mc. phone)

W 1AJZ-6; 1CJC-7; 1GJY-6; 1FD-7; 2A10-6; 2BSD-8; 2GDU-6; 2HTI-7; 2SZ-6; 2UK-7; 3AHS-6; 3BNC-5; 3CDU-5; 3WD-6; 4ADY-6; 4AH-6; 4CY-7; 4DGS-6; 5ACF-7; 5AHK-7; 5AKI-5; 5BFS-6; 5DCP-7; 5DDK-7; 5JC-6; 6ANU-6; 6BHO-6; 6CLS-7; 6CQG-7; 6DWA-6; 6EFC-6; 6ETX-5; 6FTJ-7; 6GAL-5; 6ISH-6; 6IZB-7; 6JYH-6; 6KSO-7; 6LFD-7; 6MMW-6; 6SJ-7; 7FAA-6; 7FU-6; 7QC-7; 8CD-6; 8CNA-6; 8DLO-5; 8FC-5; 8CLA-7; 8IAF-6; 8JAK-5; 9ARA-6; 9CCM-6; 9CHI-7; 9CVM-7; 9DGY-5; 9DKU-5; 9DTJ-7; 9LD-8; 9MRH-8. — C06GM-7; G3HH-5; F8DC-5; K6CMM-8; K6KDX-6; LU8DR-7; OA4KR-6; OA4AA-6; ON4VK-6; PK1MX-6; PK4AU-5; TI2RC-7. — VE 1DQ-5; 3HC-6; 4CW-5; 4LX-4; 5HU-7; 5OT-5. — XE1G-7; XE1CS-4; XE1V-7.

C. J. Nolf, ON4NC, Chateau de Rameignies, par Thumaide, (Hainaut), Belgium

September, 1936

(28 Mc.)

CN8MQ; E18B; FB8AB; G5VF; G6CL; G6DH; J2CE; LU1EP; LU7AZ; LU9AX; OA4J; OH7NC; OH7ND; OH7NF; ON4AU; ON4JB; SU1JT; VE3ADM; VE4QZ; ZE1JJ; ZE1JU; ZS1H; ZT28. — W 1ELR; 1I0B; 2AJF; 3CYX; 3EPA; 3BIW; 3BZ; 4AJY; 4DGL; 4AUU; 4DMR; 4AR; 4AH; 5EHM; 5BEE; 5SL; 6GRX; 7AMX; 8OWD; 8MWY; 8AN0; 8MWL; 8IWG; 9GFD.

(28 Mc. phone)

VE2KX. — W 1CCZ; 1CCV; 1ILQ; 3AIR; 3EMM; 3BEK; 3AUC; 4DSY; 4EBM; 4FT; 5DUQ.

E. Crockett, Jr., W9KG-W9ALV, Weston, Mo.

Sept. 27 to Nov. 15

(28 Mc.)

D3DSR; D4GFF; D4MDN; D4QET; D4XCG; D4XJF; F80B; FB8AB; G2AX; G5QV; G6DH; G6QZ; J2IS; LU9BV; OE1FH; OK2HX; OK2MV; OK2RM; ON4CJJ; OZ7KG; PAOZK; SM5VW; SM7UC; M7YA; VK3YP; VK4EI; VP2AT; VP5GM; XE1AY; YM4AA; Z1H.

D. W. Rowe, W9BPU, 513 Kreitzer Ave., Bloomington, Ill.

Oct. 4 to Nov. 4

(28 Mc.)

CM6FA; CM8AH; D3DBN; D3DLC; D4FND; D4IGH; D4KPJ; D4LTN; D4MDN; D4QET; D4SMO; D4XJF; D4XJG; D4XQF; E1LZ; E14J; E18B; F3DN; F3KH; F3KS; F8CP; F8EF; F8EO; F8GQ; F8KJ; F8SN; F8VS; F8WK; FB8AB. — G 2A0; 2HG; 2HX; 2I0; 2MV; 2NM; 2P1; 2QT; 2RD; 2TM; 2XO; 5BP; 5IS; 5JU; 5OJ; 5QY; 5YV; 6BS; 6CL; 6DH; 6GO; 6GS; 6IR; 6IS; 6LK; 6NF; 6NJ; 6OS; 6QB; 6QL; 6QZ; 6RH; 6VF; 6VX; 6WY; 6YU. — HAF8D; I1KN; J2LU; J2IS; J3FJ; J5LX; K5AY; K6MVV; K7PQ; LU6AG; LU7AZ; LU9AX; LU9BV; OE1HF; OE1ER; OH3NP; OH7ND; OK2OP; OK2RM; OK2RS; OK2HX; OZ2M; OZ3J; OZ7K; ON4AP; ON4DL; ON4JB; ON4NC; PAOAPX; PAOAZ; PAOKW; PAOQQ; PAOXK; PAOZK; SM5VW; SM6VL; SM7FC; SM7UC; VK2G; VK2LZ; VK3PL; VK3SN; VK3YP; VP5AC; XE1AM; XE1AY; XE1CM; YM4AA; Z1IDV; ZL2GQ; ZS1C; ZS1H; ZT2B; ZT6M; ZT6Y; ZU1C; ZU6P.

Nov. 8

D3CSC; D4AKK; D4KPG; D4LYN; D4XCG; D4XQF; F8CT; F8KJ; F8WK; G2DH; G2I0; G2PL; G2TM; G2WQ; G5QY; G5RF; G5SY; G6CL; G6DH; G6FQ; G6QZ; G6WN; G6ZU; HAF1G; HAF8D; HB9R; OARG; OH3NP; OK2MV; SM6WL; TF3R; U1AD; U1CR; VP5GM; YT7MT; ZE1J; ZS1H.

DX

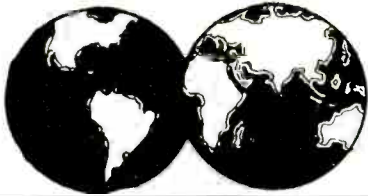

By **HERB. BECKER, W6QD**

Readers are invited to send monthly contributions for publication in these columns direct to Mr. Becker, 1117 West 45th Street, Los Angeles, California.

UN2A Now EL2A

At last we have the definite low-down on EL2A (ex-UN2A). This was sent to this department by W8ZY, who is a personal friend of EL2A, and maintains a regular sked with him. In the first place EL2A is ex-W8BIS from Akron, Ohio . . . will probably be in Liberia for two years in charge of commercial radio station. Hank does not use the commercial rig in the ham bands, but as a matter of information these rigs are two 5 kw. HF Collins outfits. A new "Super Pro" for receiving is used. The set-up at EL2A consists of a 47 osc. on 40, p.p. 46's, 203A buffer, and push-pull 852's with from 600 to 1000 watts input, all stages link coupled. He uses a Yagi type beam hung among the trees and knob-bellied natives, and outside of the fact that he has had a couple of cracks of malaria, he is getting along fine. EL2A is now having some QSL cards printed so all of you boiled owls who figured never to deceive a card from him . . . just keep your . . . or anyway, just be patient and you'll get it. Address him EL2A, c/o John Cooper, Govt. Radio Station ELA, Monrovia, Liberia, Africa. As for o.m. Duerk, W8ZY, he is still going quite strong . . . but what interests me is the dural vertical antenna he has been using with huge success. By the way, Bill "28 Mc." Conklin, W9FM, has a little story on 8ZY's antenna elsewhere in this issue of RADIO (page 76).

From J. V. McMinn, NZ16W, a New Zealand short wave listener comes the following: "The new QSL manager for all "I" stations is our old friend, Ing. Roberte Ognibene, I1IR (ex I1IP and XZA1C, the latter call being a fictitious one used last year) . . . and all cards should be sent under cover with no mention of radio on the envelope, to his QRA, viz . . . Corsa Magenta 45, Milan, Italy. Send cards (enclosed!) direct to this QRA only and *not* via Bureau or the R.S.G.B." More from McMinn: "XOZSUB with a T5 sig on the 14 Mc. band in September gave his QRA as the Indian Ocean aboard a ship bound for Ceylon. At home, OZSUB claims to have worked the world with 7 watts input. G8BD in Portsmouth operates on 7032 kc. and 7280 kc. with 10 watts input, also on 14,064 kc. HK5JD (ex-HJ5AK) is the call of J. B. Delgade C, Box 24 Palmira-Valle, Colombia, and operates on 7 Mc. only. YR5IG uses a Hartley with 14 watts input.

HS1PU with a T7 note and VS4CS in British Borneo on phone, are two newcomers on 14 Mc., together with MX2AN, a T9 signer! ! Mac would like to know the QRA of HG1AA . . . Do you know it?

G6QX, Bob Jardine, says that many fellows bawl him out for not QSLing, and would suggest that they send envelopes to their respective bureaux, as he has spent many long hours writing and answering cards. Bob also states that he is sold on the W3EDP antenna, as it is better than anything he has previously tried, especially for flexibility.

Charlie Pine, W9CWW, of Leavenworth (Kansas) has been a ham for 15 years, has always used low power with never more than 90 watts input. He had 5 continents for 9 years and couldn't hook an African until this fall when he worked 5 of 'em in October. Another interesting and peculiar thing . . . he first worked our old friend VK5HG on June 26, 1927, and nine years later on June 26, 1936, he worked him again the QSO's lacking only a few minutes of being exactly 9 years. Some of the dx that Charlie has worked with his p.p. tens includes OE1FH, ZT5G, ZT2Q, ZS2F, FT4AG, OK1AB, HB9X, OH3OI, OH7NI, D3FZI, D4PZI, D4WXXG, D4ILT, PA0QQ, PA0SD, EI3J, ON4IF, F3AU, KA1MD, J3DE, J8CA, PY2BX, PY2CW, PY5QD, LU8EN, LU3EV, CT1ZZ, U1AD, U9MI, OH5OH.

QSL cards for U9MJ, U9MI, U9MF can all be sent to: Box 48, Sverdlovsk, Ural, U.S.S.R., and



This snapshot caught some of the OK hams at their annual "Czechoslovakian Mardi Gras" fun festival, imitating some of their town-folks. In the foreground are OK2BR and OK2AK (right). In the background, left to right, are Mrs. Plish, Mr. Plish (parents of OK2AK), and OK2DD.

for you fellows who want to try to get a card out of YL2BB, his QRA is Olg. Resnais, Marijas 117-14, Riga, Larvia. This info. from W9ZT, Burt Waldron . . . and he goes on to say that UE3EI at times signs U6AAM. New ones for 9ZT are J2CC, XU8ZT, HB9T, OZ70, OZ2M, ES4D, and ES5C.



COUNTRIES OF THE WORLD AND PREFIXES

Abyssinia. see Ethiopia	Ethiopia (Abyssinia) ET	Maldiv Islands VS9	Salvador YS
Aden	Faeroes, The OY	Malta ZB1	Sardinia
Aegean Island	Falkland Islands VP8	Manchukuo MX	Samoa, U. S. K6
Afghanistan YA	Fanning Island VR3	Marianas Islands	Samoa, Western ZM
Alaska K7	Federated Malay States VS2	Marshall Islands	Sandwich Islands
Albania ZA	Fiji Islands VR2	Martinique FM8	Sarawak VS5
Aldabra Islands	Finland OH	Mauritius VQ8	Saudi Arabia
Algeria FA	Formosa. see Taiwan	Mesopotamia. see Iraq	Seychelles VQ9
Andaman Islands	France F	Mexico XE	Siam HS
Andorra	French Cameroons. see Cameroons	Midway Island K6	Sierra Leone ZD1
Anglo-Egyptian Sudan ST	French Equatorial Africa FQ8	Miquelon & St. Pierre Islands FP8	Socotra
Angola CR6	French Indochina F18	Monaco	Solomon Islands VR4
Arabia. see Saudi Arabia	French Oceania FO8	Mongolia	Somaliland, British VQ6
Argentina LU	French West Africa FF8	Morocco, French CN	Somaliland, French FL8
Ascension Island ZD8	Galapagos Islands	Morocco, Spanish EA9	Somaliland, Italian
Australia VK	Gambia ZD3	Mozambique CR7	South Georgia VP8
Austria OE	Germany D	Nepal	South Orkney Islands VP8
Azores Islands CT2	Gibraltar ZB2	Netherlands PA	South Shetland Islands VP8
Bahama Islands VP7	Gilbert & Ellice Islands, and Ocean Island VR1	Netherlands West Indies. see Curacao	Southwest Africa. see Union of South Africa
Bahrain Islands VS8	Goa CR8	New Caledonia FK8	Soviet Union U
Balearic Islands EA6	Gold Coast (and British Togoland) ZD4	Newfoundland and Labrador VO	European States UI-7
Baluchistan	Gough Island	New Guinea, Neth. PK6	Asiatic States U8-9-0
Barbados VP6	Great Britain G	New Guinea, Territory of VK9	Spain EA
Bechuanaland	Greece SV	New Hebrides, British YJ	Spitzbergen. see Svalbard
Belgian Congo ON	Greenland OX	New Hebrides, French FU8	Straits Settlements VS1
Belgium ON	Guadeloupe FG8	New Zealand ZL	Sumatra PK4
Bermuda Islands VP9	Guam OM, K6	Nicaragua YN	Surinam. see Guiana, Neth. PZ
Bhutan	Guatemala TG	Nicarob Islands	Svalbard. (Spitzbergen) SM
Bismarck Archipelago	Guiana, British VP3	Nigeria (British Cameroons) ZD2	Sweden HB
Bolivia CP	Guiana, French, and Inini FY8	Niue ZK2	Syria
Borneo, Netherlands PK5	Guinea, Portuguese CR5	Non-Federated Malay States VS3	Taiwan (Formosa) J9
Brazil PY	Guinea, Spanish HH	North Borneo. see British North Borneo VS4	Tanganyika Territory VQ3
British Cameroons. see Nigeria	Haiti K6	Norway LA	Tangier Zone
British Honduras VP1	Hawaiian Islands K6	Nyasaland ZD6	Tannu Tuva
British North Borneo VS4	Hejaz HZ	Ocean Island. see Gilbert & Ellice Islands VR1	Tasmania VK7
Brunei	Honduras HR	Oman	Tibet
Bulgaria LZ	Hong Kong VS6	Palau (Pelew) Islands	Timor, Portuguese CR10
Burma VU	Hungary HA	Palestine ZC6	Togaland, British. see Gold Coast
Cameroons, French FE8	Iceland TF	Panama HP	Togoland, French FD8
Canada VE	Ifni VU	Papua Territory VKA	Tokelau (Union) Islands
Canal Zone NY, K5	India EP	Paraguay ZP	Tonga (Friendly) Islands VR5
Canary Islands EA8	Iran (Persia) YI	Persia. see Iran EP	Transjordan ZC1
Cape Verde Islands CR4	Iraq GI	Peru OA	Trinidad and Tobago VP4
Caroline Islands	Ireland, Northern GI	Philippine Islands KA	Tristan da Cunha ZU9
Celebes and Molucca Islands PK6	Irish Free State EI	Phoenix Islands VR6	Tunisia FT4
Ceylon VS7	Italy I	Pitcairn Island	Turkey TA
Chile CE	Jamaica and Cayman Islands VP5	Poland SP	Uganda VQ5
China XU	Japan J	Portugal CT	Union Islands. see Tokelau Islands
Chosen (Korea) J8	Java PK	Portuguese India. see Goa CR8	Union of South Africa ZS-ZT-ZU
Christmas Island ZC3	Kenya VQ4	Principe & Sao Thome Islands	United States (N) W
Cocos Islands ZC2	Kerguelen Islands L8	Puerto Rico and Virgin Islands K4	Uruguay CX
Colombia HJ	Korea. see Chosen	Reunion Island FR8	Venezuela YV
Comoro Islands	Laccadive Islands YL	Rhodesia, Northern VQ2	Virgin Islands. see Puerto Rico K4
Cook Islands ZKI	Latvia VP2	Rhodesia, Southern ZE	Wake Island K6
Corsica	Liberia EL	Rio de Oro	Windward Islands
Costa Rica TI	Leeward Islands	Romania YR	Wrangel Island
Crete	Liechtenstein LY	St. Helena ZD7	Yemen
Cuba CM, CO	Lithuania LT		Yugoslavia YT-YU
Curacao and Netherlands West Indies PJ	Luxembourg CR9		Zanzibar ZK1
Cyprus ZC4	Macau F88		
Czechoslovakia OK	Madagascar F88		
Danzig YM	Madeira Islands CT3		
Denmark OZ			
Dominican Republic HI			
Easter Island			
Ecuador HC			
Egypt SU			
Eritrea			
Estonia ES			

E. L. Walker, W8DFH, has hooked some nice ones and here are a few of the better ones: CR9AB, J8CA, PK1GW, PK1MO, PK1PK, PK1RA, PK1RY, PK1BX, PK3LC, PZ1AL, UN2A, VR4BA, VR2FF, XU3FK, XU3ZC, XU6SW, XU6AZ, XU8RL, XU8OP, XU8LR, YJ2K, J6DK, U9AC, U9AL, U9AZ, U9MI, U9MJ, U9ML, U9MF, U97FY, VQ8AA, VQ8AF, VS6AG, VS6AH. Walker says his son is doing most of the dx snagging lately and has just been issued a call of his own, W8QJV.

8DFH has 34 zones and 84 countries. W2ALO, Jules Obester, gives some good ones to look for: ZB1C 14,270 kc. T9; ZP2AC 14,370 kc. T9; FT4AA 14,010 kc. T9; VR2AB 14,370 T8; FB8AF 14,350 kc. T9; VU7FY 14,395 kc. T9; FT4AC 14,000 kc. T7; FT4AE 14,420 kc. T9; FB8AD 14,270 kc. T9; YR5OR 13,990 kc. T9. Jules worked J1GG one night about 7 p.m. but it turned out to be a Japanese yacht, 250 miles east of Gibraltar, hi. W3EDP, Hy Siegel kicks thru with some of his

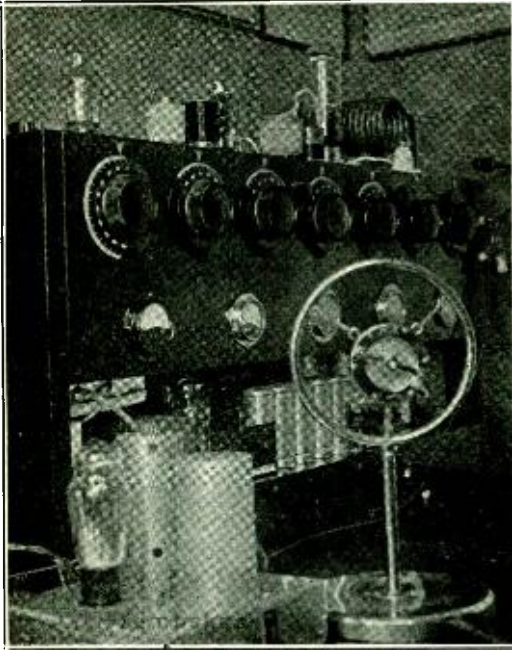

The transmitter of LY1J, probably the most widely known Lithuanian ham. He has worked 37 zones and 88 countries.

dx: KA1MD, PK1BX, J2JJ, ZS5Z, 11LD, FB8AF, SP1LM, CE3AR, PY7AJ, PY8AE, ZT6AQ, FR8VX, FT4AA, OH6NN, 11RRA, ZE1JV, VQ8AF (these being on 20), while the following were worked on 10: G6WN, G2RD, ZU1C, T12EA, ZT6M, SM5VW, OE1FH, F8OB, G2IO, U3QR, ZL1DV, VK3YP, SM5XW, 11KN, ON4AU, D4QET, D4FND, HAF8D, F8WQ. Hy says that the boys who want to get zone 2 should keep their ears open for VE5TV on Nottingham Island off Baffinland. (What frequency, Hy?) VE5TV says he will QSL all contacts, but you will have to wait for about a year due to his isolated station, and the fact that only about one or two ships call during a year. 3EDP put up a new sky wire and rolled off the six continents in 3 hours and 48 minutes. What kind of an antenna is it, anyway . . . or mebbe it's a secret.

VK3EG Is Winner

VK3EG used 7, 14 and 28 Mc. in the recent VK-ZL contest and had 750 QSO's in 77 countries and ran up a total of 251,000 points, which looks plenty good. Operating time was 130 hours. Other scores are, VK3MR 110,000; VK4BB 129,000; VK5FM 150,000. Ivan worked W6TI and W6KWA the long way around on 14 Mc., and reported hearing W8BTI at 1730 G.m.t. which is mighty unusual. W6TI scraped up this bit of info. from VK3EG and also learned while QSO with G2ZQ that he worked his 130th country by snagging ZP6AB. Ronald Moran, W3EJO who has been a ham since 1915, worked J8CG on 14,270 kc., and he claims that is about the only one he has worked that hasn't appeared in these columns. The first time 3EJO ever tried 20 meters was in July 1935, and since that time he has worked 34 zones and 92

countries. Has 1124 foreign QSO's and runs 600 watts to a pair of 211's.

Keat, W9KG-W9ALV, has been doing o.k. with his 90 watts at 9ALV. These have been worked: KA1AN, G5DJ, CT1ZZ, KA1MD, J3FZ, KA7EF, VU2FD, PK1MO, G5VB, J3EM, VU2AU, CX1BN, 11KN, OZ3D, XU8OP, PY2BX, HAF8D, PY2BB, PK4KO, ZU6AF, ZU6L, ZS2L, XU8AG, XU6AZ, PY2AC, PY1DC, HAF4H. Keat says his QRA at Weston, Mo., is a lot better than his spot in K. C. where the 9KG part of it is located. W9LBB is not on very much now as he has become a traveling salesman . . . (Hey, watch out, you farmer's daughters.) W9TXG and W9GK have been doing some pretty good dx lately. W2BMX claims to have the world's lousiest location. Says he is situated in the Berkshire mountains at Dover Plains, N. Y., and the sigs just seem to bounce over him. In the seven years he has been on the air he has only heard two J stations and worked one of them, J3CR, for his w.a.c. 2BMX uses a pair of Taylor 756's in the final at 100 watts input.

Reg Tibbetts, W6ITH, in the past S.S. contest worked all 69 sections, with 223 stations and a total of 30,744 points. He used six bands (the 1.8, 3.9, 14, 28, 56 and 112 Mc.) He says all reports were 5R8 or 5R9 and that only two-way phone was used during the entire contest.

My friend W6KZL and his wife just returned from a tour of the country. They are a very fine dance team, and it is quite interesting to see them traveling with a complete trailer in which he has a 800 watt rig. In their travels they have met hundreds of hams and have taken in a few conventions. The last one I think was that one in Chicago, from which (if I remember correctly) 8CRA got stuck for a way



This picture, taken about a year ago, would have been labeled "OK2AK and Y.L." if run before, but now it is "OK2AK and Wife".
O.k., 2AK: congratulations!

to get back to dear ol' Cannonsburg. Anyway, W6KZL said that the most consistent dx signals they heard while on the road were PA0JMW and G6NJ.

W7BLT worked ZB7AC, who said he was in Palestine. Is he or isn't he? 7BLT has 27 zones. W6BAM hooked up with TF3PF, who was on 14,350 kc. with a T7 note, and that made 6BAM zone 30. BAM uses a Taylor 814 with 250 watts. . . . And now along comes another W6 with some dx . . . but before I go into that I suppose some guy on the east coast will let out a squawk, for not mentioning

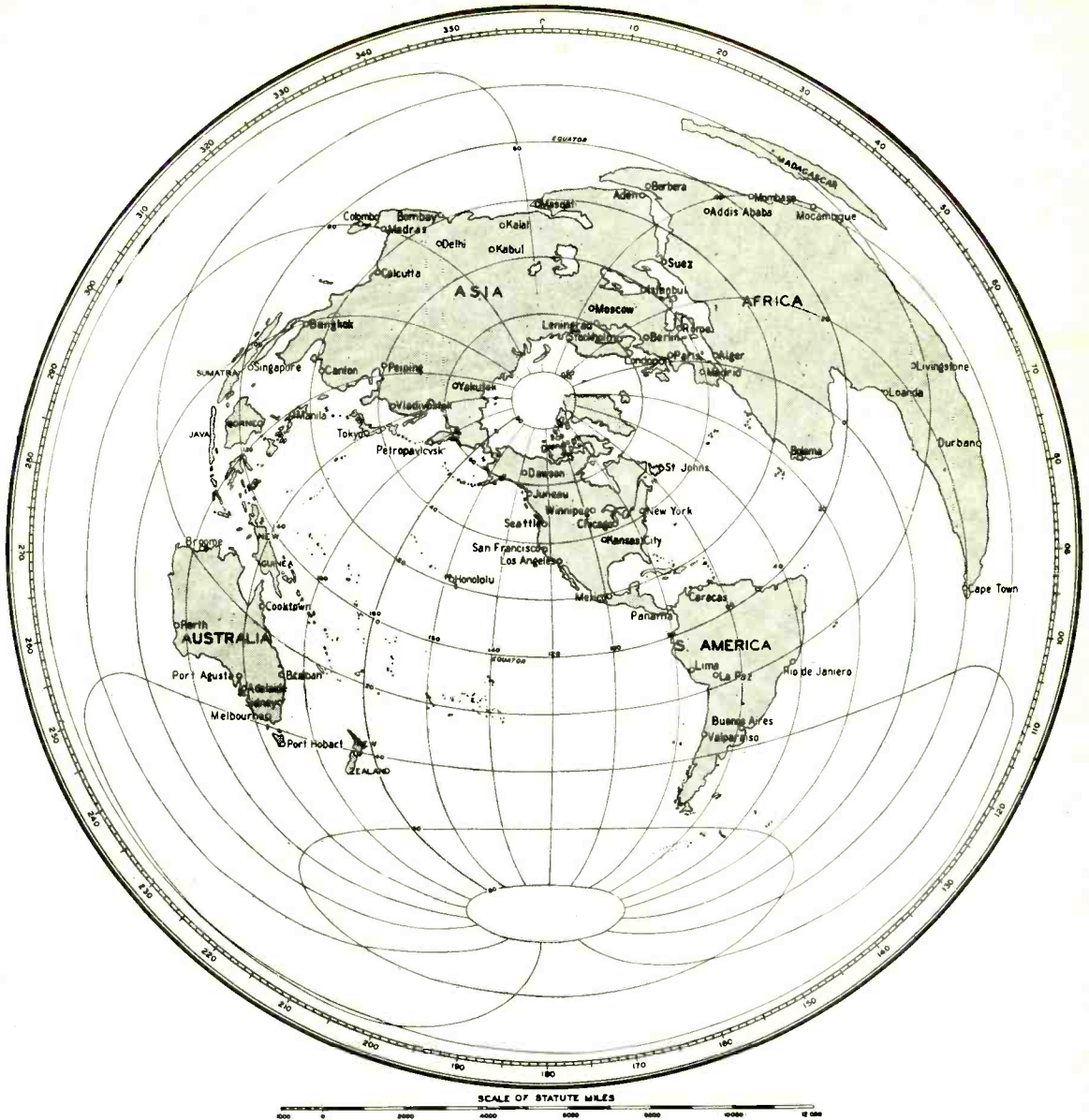

GREAT CIRCLE MAP OF THE WORLD

Centered on San Francisco

The great circle distance from San Francisco to any other point on the surface of the globe may be scaled off directly on this map using a straight-edge and the scale of miles shown directly below the map. Melbourne scales roughly 8000 miles from San Francisco. Distances of distant points from other cities in the western United States can also be scaled off directly with sufficient accuracy for most amateur purposes. To determine distance in kilometers multiply miles by 1.6.

The great circle direction of any point from San Francisco may be determined by laying a straight-edge from San Francisco to the point whose direction it is desired to determine. The point at which the straight-edge crosses the numbered circle will give the direction. Thus Durban, South Africa, lies about $13\frac{1}{2}$ degrees north of east from San Francisco ($76\frac{1}{2}$ on the numbered circle). Verify this on a globe if you doubt it.



A group of well-known Lithuanian amateurs. Left to right: Back row, LY1VV, LY1KK, LY1AL. Center row, LY1HB, LY1AF, LY1MB, LY1AK, LY1AD, LY1AB, LY1AI. Bottom row, LY1X, LY1S, LY1AA, LY1ZB, LY1J. Amateur licenses are probably obtained more easily in Lithuania than any other country. Any citizen may get a license at a cost of 10 Litass (\$1.60). It is good forever, no examination is necessary, and amateurs are permitted to use all bands.

the W1's or W4's, or so-and-so from Sleepy Hollow will exclaim in wild anguish, "Shucks, I work more than those lousy sixes do but nobody pays any attention to me." It's not so much that you might actually be from Sleepy Hollow that I care about, but how in the devil can this dx dept. publish anything that it doesn't have . . . So, my fine thoroughly-squelched friends from east coast "clear way over to this west coast" . . . no matter whether you think it is good dx or not . . . send it in now. It might be the best dx ever worked from your particular section. And while I'm beecing about something, might as well remind you to look over the *new* Zone map and figure out how many you have worked.

As I was about to say five minutes ago, here's another W6 who has worked something unusual . . . The six is W6ERS in Frisco town (beg pardon, you're s'posed to say *San Francisco*, when in the presence of a native San Franciscan) . . . and the guy that W6ERS worked was ST2B in Egyptian Sudan. His frequency was 14.480 kc. with a d.c. note. Guess we'll have to start tuning all over the commercial frequencies to get 'em all.

W3EMM did a pretty good job of making a phone w.a.c. in 8 hours. And here's one from Greenwich, Conn.: W1AVB, who says he has an "under-excited" 830 in his final with 90 watts input, makes use of his attic by stringing up a half wave antenna in it, and with this hooked on his lil rig he has worked 30 countries, which is not bad at all. W8LEC is another one who has added a Zone by working this VE5TV on Nottingham Island. That makes 34 now. Dick also gives forth this info. . . . VP2GA, Grenada, says that VP2DF had an accident and has been in the hospital . . . that in sending a card to OS1BR at Suez, it came back marked, "Uncorrect Adres", so that guy's QRA is still up in the air apparently. Some dx that 8LEC has worked . . . VP9R, YV5AP, VQ8AA, FB8AD, FR8VX, U9MI, U9MJ, U9AZ, FA8JO, XU8OP, URRA, LA4K, KA1MD, KA1AP, U9ML, ZS1Z,

ZT2Y, ZT6S, ZT6AU, ZU6AF, VP4AP Tobago, and VP2GA.

W9NTW nominates a certain W8 for a feller who really was out of luck . . . this W8 took a week's vacation and planned to spend it working some dx, only to find out that the Sweepstakes Contest was the same week. And he couldn't change his vacation. Ho-hum. W6JNL says that VQ2RS has a receiver as he worked him on Oct. 2nd, and wanted especially to let G2ZQ in on it.

W5EOW in Dallas said he darn near made WAC in 39 minutes, but just couldn't land a station in North America . . . tough, eh what? In between QSO's he wrote this little pome, which isn't so bad for around dx contest time. Here goes:

The DX Contest

*Every morning 'bout half past four,
I slip on my pants and sneak out the door,
Out to the shack I run like beek,
To warm up the tubes and get a frequency check.
Listen 'bout an hour, don't hear a thing,
Haven't worked a furriner since way last spring.
Hear a CQ, my heart gives a bound,
Till he signs W5, just across town.
Now some folks say there aint no hell,
But they ain't hams, so they can't tell.
When fall rolls around I take another chance,
And buy 66's instead of new pants,
Buy a new receiver when the old one's best,
But I'm darn sure ready for the next contest.*

—W5EOW.

W9WCE is another firm believer in low power . . . uses 45 watts into an 801, and worked a flock of good stuff. He gives as the QRA of VP4AP . . . Scarborough, Tobago, BW1. W3QM reports that some of the better dx done by his station includes: ZU6AF, MX2B, ZT2E, ZT6AY, J3FI, ZS2X, U3AS, PK1BX, KA1AP, FT4AA, CN8AH, SP11H,



This picture was taken just outside the shack of W8CRA and shows Frank (right) and his pooch "Judy". The little purp answers to the name of "D-X".

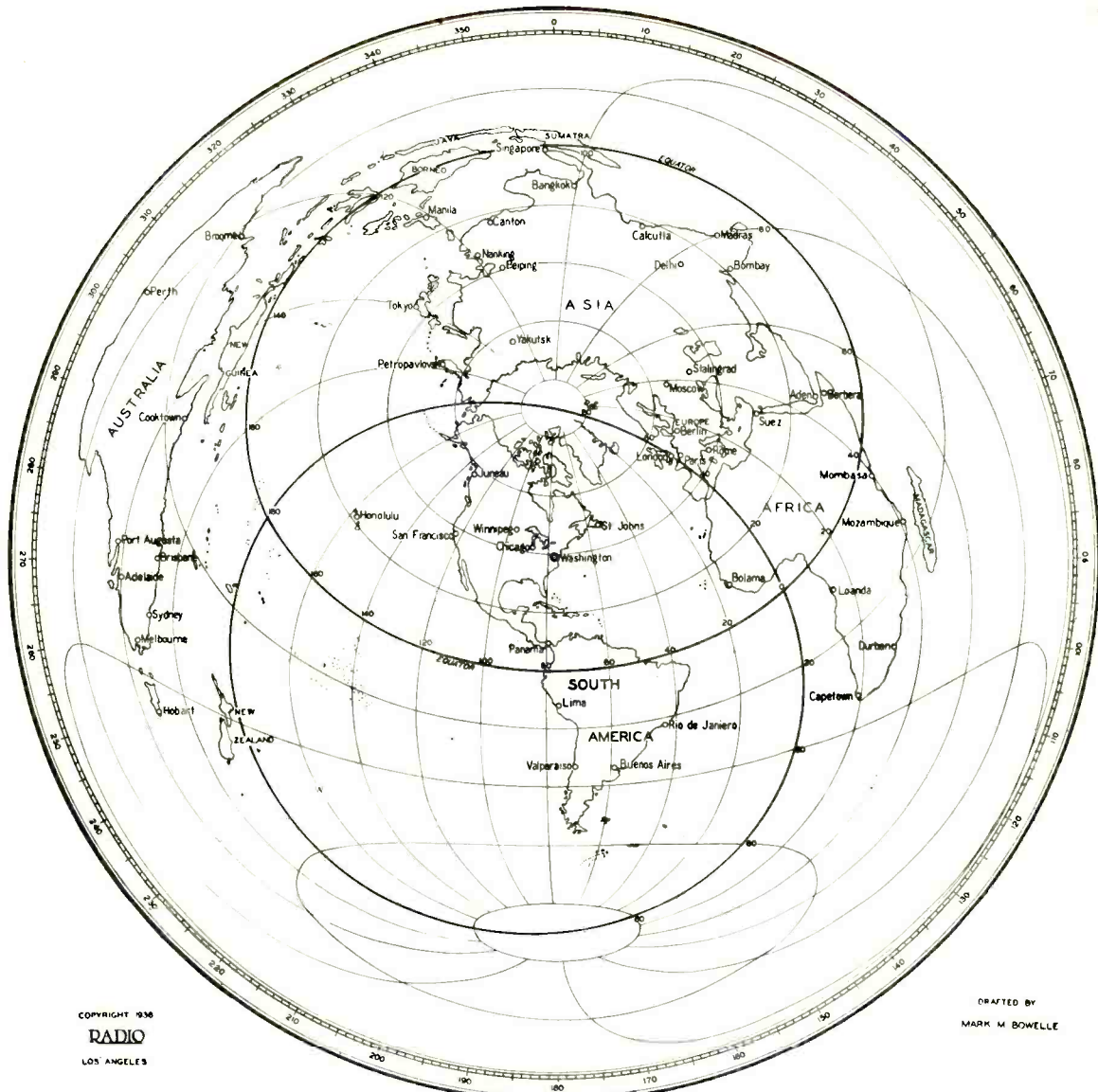

COPYRIGHT 1936
RADIO
 LOS ANGELES

DRAFTED BY
 MARK M. BOWELLE



GREAT CIRCLE MAP OF THE WORLD

Centered on Washington, D. C.

The great circle distance from Washington to any other point on the surface of the globe may be scaled off directly on this map using a straight-edge and the scale of miles shown directly below the map. Perth, Australia, scales roughly 11,500 miles from Washington. Distances of distant points from other cities in the eastern United States can also be scaled off directly with sufficient accuracy for most amateur purposes. To determine distance in kilometers multiply miles by 1.6.

The great circle direction of any point from Washington may be determined by laying a straight-edge from Washington to the point whose direction it is desired to determine. The point at which the straight-edge crosses the numbered circle will give the direction. Thus Perth lies about 33 degrees north of west from Washington (303 on the numbered circle). Verify this on a globe if you doubt it.



"WAZ" HONOR ROLL

G2ZQ	39	W8BTK	32
W3SI	39	W5EHM	32
W6CXW	39	W2BJ	31
W4DHZ	39	W3DCG	31
W8CRA	39	W2FAR	31
W6GRL	39	W5CUJ	31
W6ADP	39	W9KA	31
W3PC	39	W3EXB	31
W9TJ	38	W6BAM	30
G5YH	38	W6GHU	30
G6WY	38	W9WE	30
W6CUH	38	W3EVW	30
W6QD	37	W9LW	29
W8BKP	37	W6FKZ	29
W2GWE	37	W6GNZ	28
W8OSL	37	W5EOW	28
W6FZY	37	W3CIC	28
G6NJ	37	W9JNB	28
W2DTB	37	W6HJT	28
LY1J	37	W3EYS	28
W9PTC	36	W6CEM	28
W6GAL	36	W6JBO	28
W6AM	36	W7BLT	27
W9KG	36	W8WBW	27
W3EDP	35	W6FZL	27
W6HX	35	W8BOF	27
W2BSR	35	W8FJN	27
W1CC	35	W6FET	26
W1ZB	35	W9DEI	26
W8KPB	35	W6IDW	26
W8LEC	34	W2ALO	26
W8DFH	34	W6ITH	25
W3EJO	34	W9MKO	25
W9LBB	33	W6KRM	25
W5AFX	33	W2DZA	25
W9ARL	33	W7AHX	25
G6QX	33		
W9AFN	33	Phone:	
W9ALV	33	W5BDB	27
G6CL	33	W6AM	23
W8AAT	32	W6ITH	21

If you have worked more than 25 zones and are willing to produce confirmation on demand, send in your score on a postcard.

Phone stations need work but 20 zones, but stations must be raised on phone. Stations worked may be either c.w. or phone.

OK4KW, YR5AE. 3QM uses an RK-18 final with 100 watts input.

Ol' Pete, G2PL, says that a lot of the gang have gone on phone, including himself. Pete is using a T-55 now with about 100 watts input, and has added three new countries to his list. They are MX2B, FR8VX, CR9AB. Also says he started the VK-ZL contest with a bang but the last part of it was spoiled by YL QRM . . . so he "chucked it" (the contest).

This is a good spot to call your attention to the Zone map which you will find in this section. The boundaries are as accurate as can be made with information at hand, and I would suggest that you hang on to this issue of RADIO for future reference. Many fellows have asked for the map showing the Zones and now that it has been brought up to date we should have many new calls added to the list.

What Is a Country?

For years the dx boys have been squabbling over their countries and I dare say that it would be hard to find any two of them that would agree 100%. One would say, "I have 108 countries." And some guy would pop up with, "Well, if I counted mine that way I would have 169." And so it would go indefinitely. Therefore, in order to get some sort of a standard for comparison, RADIO has been working on a country list for the last few months. Just when we were about ready to "let fly", the A.R.R.L. came out with its "dx map", giving its interpretation of what constitutes the different countries. As its list coincides reasonably closely with the list we compiled, and because its was out first, we are acknowledging that list instead of running our own version. After all, the important thing is that amateurs throughout the world agree, rather than who compiled the list or how the doubtful countries are counted. The "official" list of countries appears herewith.

Activity around the shack of QD this month will hit a new minimum, because on December 1st we were duly informed that the property on which the station is located had been sold. The new owners thought it would be a good idea to start the new year right by moving the whole 'mess'. Soooo back to the old QRA it goes, which is Manhattan Beach . . . and down comes a nicely working diamond beam, a 1200 foot antenna to an oil derrick, and a couple of incidental sky-wires. The old location is not so hot, so the next time the call letters of W6QD are heard floundering around in the mud, their strength will probably be a couple of points weaker. But still I can't help but feel that they will pack enough to get into the W9's ok.

Now . . . to the dx gang throughout the world, and that means the foreign hams as well as those in the U.S.A. (including W9's), I want to wish an extra Merry, Merry Christmas, and a rip-snorting Happy New Year, with plenty of 1937 dx.

28 AND 56 MC. ACTIVITY

By E. H. CONKLIN, W9FM

One of the most interesting phenomena on 28 Mc. to report this month is the reception of VK3YP by W9BPU, W9JGS, and others at around 7:30 a.m. Central time on November 2d. VK3YP was R7 at W9BPU and gave the latter an R5 report. At the time, W3AIR, W4AJY, and general east coast reception was possible in Illinois, but other dx signals did not make their appearance for two hours, when ZS1H was heard.

Two reasonable explanations might be put forward—that the signals followed the long daylight path, or the shorter darkness path, along the great circle route, with conditions as favorable as on 14 Mc. At the same time, 14 Mc. signals have been found to follow the short path through the darkness, and not to be audible in Europe. This, plus the fact that Europe and Africa were not heard for several hours, suggests that the short path may have been taken by the signal. In the summer, when VK signals are heard here occasionally, they come in not during our afternoon, but as late as ten or eleven p.m. During the late summer, VK's were heard in England as late



as 1500 G.m.t. or 2:00 a.m. in Melbourne and Sydney, Australia. Summer conditions on 14 Mc. also permit late evening or night work—and November approaches midsummer in Australia. VK3YP was operating just before midnight his time, at which hour here we have sometimes been able to work as close as 700 miles during our summer. Perhaps during the next year, some of our dx friends will listen or transmit at odd times throughout the day and night.

November Conditions

Crockett of W9KG-W9ALV says that in his opinion 28 Mc. is tapering off gradually but surely until next spring, inasmuch as European signals are not bouncing in as they did a year ago, while VK's and J's are very weak. On the other hand, W8ZY reported hearing J's on November 7 and 8 for the first time, and others have said that conditions were quite satisfactory. One thing is certain—there are plenty of dx stations deserting 14 Mc. and giving "ten" a try. Miss Nelly Corry, G2YL, late in October said that 28 Mc. is getting just like 14 Mc. and one might as well be on one as the other.

Australian Conditions

We have just received the October issue of *Amateur Radio*, published in Australia, in which VK3JJ conducts a "5 & 10" column. He says that during the recent winter months "down under", the only dx stations heard on 28 Mc. were a few W's and J's, while there were very few VK stations active to work with them. An improvement was noted early in September with W signals increased greatly in strength, making contacts easier. Europeans also started to come through again. ZS1H was heard with weak signals. W6DIO and W6GRX were very consistent and about the strongest W's, working plenty of VK's and ZL's. J3FK was putting in a good signal weekends but few other J's seemed to be active. VK3CP has worked five continents on phone, and is experimenting with beam antennas.

Station Reports

- J2IS: (November 1) Recently every morning W's come through very nicely, above all, W6 and W9 phones very good indeed. VK's and ZL's all day long o.k. LU6AX, LU9AX, and LU9BV heard very often during October. In evening, OK, PA, D, F, HAF, HB, G, and ZS come in here rarely, but OH7NF very often. On October 19th heard KA1XR sending V's on about 7 meters at 17:00 l.c.t.
- ON4NC: Reported that W signals from all districts started to come in on September 15, sometimes with very good volume. South Americans and ZS1H were heard but no VK or ZL. J's came in on the 20th. Using grid-modulated phone, 40 watts to a pair of 46's.
- VE3RS: Worked 31 countries on "ten". Found a poor dx period in the middle of October but conditions good to work W's in midwest and west. Needs Asia for w.a.c.
- W8ZY: Using 250 watts to a T-55 final, with a 66-foot vertical antenna. Have been working considerable dx on 28 Mc. recently. Heard several J's on the weekend of November 7-8 when conditions were quite satisfactory.
- W9JGS: Plenty doing on 10 meters. Heard VK3YP in early morning on November 2. Heard SU1SG for first time. SM stations are loudest from Europe.
- W6JNL: Starting November 1, band was hotter than 14 Mc. as far as hearing all continents consistently was concerned. Europeans S6 to S7 in mornings with PA0AZ most consistent. ZS1H is only African coming through but is heard daily. J2LU is in during early afternoons and lasts till evening. Late afternoons LU9AX is S7, as most consistent from South America. Rig here RK20 with 85 watts input, working into 133-foot end-fed antenna.
- W6ITH: On phone exclusively; working VK2GU daily for an hour giving him the Simpson news. VK2GU has

moved to 28,120 kc. to avoid the c.w. QRM on low frequency end of band. Have planned diamond antenna for Europe.

W9BPU: Worked all continents this autumn, using 6L6-804-150T with 450 watts input. The morning of November 8 was particularly good for Europe and Africa; heard U1CR and U1AD in Russia, YT7MT in Yugoslavia, and TF5R in Iceland. Worked 30 countries on "10".

W5FJ: Band opens here about 8 a.m., usually going dead about 6:30 p.m. Europeans come in until 1:30 or 2:00 p.m., then Aussies start about 4:30 p.m. October 31 was almost completely dead. Had a nice contact with mobile W6CNE who was on an RKO set filming a picture. Jack Oakie and other stars came on to talk with us.

The first part of December, Jerry Gorman, W6JJU, hooked SU1SG on 10 meters for the first 10 meter SU-W6 QSO. They had a half hour solid QSO, and Jerry received an R7 report. The QSO took place at 8 a.m. (P.s.t.). Gorman was using a diamond antenna aimed in the "general direction" of SU1SG.

BRITISH REPORT

By NELLY CORRY, G2YL

During October, conditions were excellent and signals were heard from 34 countries in all continents. There were a few poor days, but as a general rule the band was open from 08.00 to 20.00 G.m.t., and at times the l.f. end sounded like 14 Mc., though there are still some wide open spaces above 28,200 kc. It is difficult to give a comprehensive account of everything heard during the month, but reports furnished by two G stations who work exclusively on this band give a good idea of what can be accomplished under present conditions.

G6DH worked 153 U.S.A. stations up to October 25, including 13 W6's and 7's, several on 'phone. His Oceanic contacts included 6 with ZL1GX, ZL3DJ and ZL2BP (on 'phone), and a dozen different Australians. Other unusual stations worked include J2IN, J2IS, J2LU, J3FJ, U9ML, VU2AU, VP2AT, and PY1BR. On October 25 he worked 5 continents in 3 hours, and heard VU2AU, but not appreciating the possibility of a quick w.a.c., did not even call him.

G6LK, another 28 Mc. "addict", worked all continents 8 times from October 1 to 25, and received R8 or 9 reports from VK, VS6, LU, W6, and ZS. His 222 contacts during this period included 15 European, 27 African, 11 South American, 129 North American, (all districts except VE5), 32 Oceanic, and 8 Asiatic. He worked ZL3DJ 8 times on "sked" at 08.00 G.m.t., and also had QSO's with ZL2BP, VK2, 3, 4, 5, 6, 7, VS6AH, VU2AU, U9AZ, J2IN, J2IS, J2JK, J2LU, J3FJ, PY1BR, and PY5QA.

The VK-ZL contest undoubtedly encouraged a number of Australians to "get down to ten" for the first time, and on Sunday mornings in October more were heard than ever before. They included VK2GU, 2JT, 2LZ, 3BQ, 3CP, 3XP, 3YP, 4AP, 4EI, 5LJ, 5WJ, 6AA, 6CA, 6FO, 6MW, 6SA, and 7AB. G6LK has worked VK4AP as late as 15.00 G.m.t.

Though VU2AU appears to be the only Indian active on the band, Japanese and Siberians have been coming through well, so that Asia is now easier to work than ever before. KA1AN reports hearing G2YL but has not yet raised a G station.

Other countries where the "28 Mc. bug" is apparently spreading are Russia and Finland, and during the month G6DH worked 8 different U's, and G2XC worked 8 OH's. African, and North and South American stations have been as consistent as last month,

[Continued on Page 170]



Again: "W.A.Z.", a DX "Yardstick"*

RADIO herewith presents a dx scheme believed to be much superior to any mere list of countries

or continents worked. It not only provides an ultimate goal which is all the more desirable because few will probably achieve it, but more important for the average dx station it provides a means whereby the progress of different stations toward that goal may be easily compared, and concisely stated.

Nearly all of us are interested to a degree in working dx. Large numbers of QSL cards proudly bear the "W. A. C." (worked all continents) designation; many bear lists of the countries or prefixes worked. Even most old-time hams like to brag that some dx stations have reported them the "loudest W— station heard here, o.m.; R99 plus!"

Despite such well-nigh universal interest in dx, there seems to be no satisfactory "yardstick" by which to measure or compare the dx performance of different stations. "W.A.C.", once the goal of every ham who was either mildly or enthusiastically interested in dx, has been "made" by such a large number of hams that it is no longer a badge of special distinction except in a few localities.

"When Is a Country Not a Country"

Realizing this, many such stations in the last few years have taken to listing the number of countries (or prefixes) worked and elaborate tables have been published of just what places are considered by the compilers as "countries". But such schemes lack the element of fairness to many stations. In several places on the earth's surface a considerable number of small countries are grouped together in one natural geographical area; dx stations that can work one easily can usually work all of them just as easily, unless some have very few hams. On the other hand, there are several large countries which lie in two or more natural geographical areas and it may be, and frequently is, a much more dif-

The w.a.z. scheme is, we believe, the best attempt yet to establish a better means of measuring dx achievement, and a fairer basis of comparison of dx records. Originally introduced in "R/9" in November, 1934, its popularity has exhausted three printings, wherefore we present a fourth—with apologies to those who are already well familiar with the plan. The accompanying map has been redrawn and lettered.

ficult feat to work stations in several parts of such a country; yet the station so doing takes credit for

working but one country.

Accordingly the editors of RADIO have attempted to evolve a zone scheme (*w.a.z.*—"worked all zones") which may be used as a fairer basis of comparison. As hinted above, it may not only be used by those who have worked all zones but also by others who can readily compare their progress toward the ultimate goal with that of other stations having the same objective. The far-from-perfect result is shown in the accompanying map and the list of zones at the end of this article. Note that the map is not "official"; it is merely intended to give the general picture. Reference should be made to the list of places in each zone to settle questions which may arise.

Not a "Racket"

It is not our intention to make a minor "racket" out of the *w.a.z.* "degree". It is *not* necessary to join any association, to subscribe to any magazine, or to obtain any certificate to be entitled to call one's station a *w.a.z.* station. The designation is simply an indication of *performance*, and nothing else. However, for those who may want a certificate as a souvenir or evidence, RADIO plans to issue at cost a neat, engraved or embossed certificate (as unlike "oil stock" as possible), upon submission of satisfactory evidence as to the number of zones worked.† Please *do not* send in inquiries, applications, or QSL cards for this purpose until further announcement is made in these pages.

The *w.a.z.* degree should of course be used only by those who have reached the goal of working all forty zones. The scheme, however, is subject to much wider application, as progress made toward that goal can be indicated by a designation such as *W'35Z.* signifying that the station has "worked thirty-five zones".

In determining zone boundaries we readily admit that no two persons in the world would probably make up exactly similar lists. Careful attention has been given to topographical maps,

*The entire contents of RADIO are fully protected by copyright with all rights reserved. Permission, however, is hereby granted to any publication appearing at regular intervals (except those published primarily to advertise the publisher's other products or services) and having a circulation among radio amateurs to reprint the text of this article in whole or in part. A credit line will be appreciated. The accompanying map may also be reproduced in such periodicals *no larger* than the size herein. Electrotypes are available at cost.

†Such certificates will probably be available not only to *w.a.z.* stations, but also to those working a certain number of zones, such as 35 or more.



calls heard lists, and similar factors in compiling the zone lists. For convenience in determining the zone in which a distant station may be located, zone lines have in most cases been made to coincide with political or call area boundaries even where *slight* departures from natural topographical boundaries were necessitated.* Deliberately no consideration has been given to the number of amateur stations which may be located within a particular zone, as this is a factor of no permanence.

A number of stations in the eastern U.S.A. have objected that the scheme has been designed

*Repeated objections to the division of the country even for such a purpose as the w.a.z. plan have been received from one of the more nationalistically inclined countries. No changes have been made on this account, however, as it is our contention that an advancing wavefront cannot recognize a political boundary even when it sees one.

to favor the west coast station because more zones have been assigned to Asia than Europe. The plan has been laid out as carefully as possible without reference to any particular country or portion of a country. The number of zones on each continent is roughly proportional to its area.

Because of the difficulty of securing widespread publicity thereon and the cost of revising maps as well as the undesirability of making obsolete maps already in the hands of users, the question of promulgating changes in the plan will only be considered at infrequent intervals.

In the following list some overlapping units are included, that is, many places listed are subdivisions of other places also listed. This has been done purposely because sometimes one of the names is omitted in the postal addresses given on QSL cards.

W.A.Z. ZONE BOUNDARIES DEFINED

Zone 1—Northwestern Zone of North America

Alaska (K7)
Yukon (part of VE5)
Canadian Northwest Territories (part of VE5)
District of Mackenzie
District of Franklin
Islands west of 102° W., including Victoria, Banks, Melville, and Prince Patrick.

Zone 2—Northwestern Zone of North America

Canada, that portion of Quebec (part of VE2) north of an east and west line drawn along and extended from the southern boundary of Labrador.
Canadian Northwest Territories (part of VE5)
District of Keewatin
District of Franklin east of Long. 102° W., including Islands of King William, Prince of Wales, Somerset, Bathurst, Devon, Ellsmere, Baffin, and the Melville and Boothia Peninsulas.

Zone 3—Western Zone of North America

British Columbia (part of VE5)
W7 except Wyoming and Montana
All W6.

Zone 4—Central Zone of North America

All VE3, VE4, W5, and W9.
Wyoming and Montana (part of W7)
Ohio and Michigan (part of W8)
Tennessee and Alabama (part of W4)

Zone 5—Eastern Zone of North America

All VE1, VO8, W1, W2, W3.
VE2 (Quebec) south of line mentioned in Zone 2
W4 except Tennessee and Alabama
W8 except Ohio and Michigan
Bermuda.

Zone 6—Southern Zone of North America

Mexico

Zone 7—Zone of Central America

Honduras

British Honduras
Guatemala
Costa Rica
Nicaragua
Panama
Canal Zone

Zone 8—West Indies Zone

Cuba
Puerto Rico
Virgin Islands
Jamaica
Bahamas
Barbados
Haiti
Dominican Republic
All Greater and Lesser Antilles except Bermuda and those listed in Zone 9.

Zone 9—Northern Zone of South America

Colombia
Venezuela
Dutch Guiana
French Guiana
British Guiana
Trinidad
Curacao
Tobago
Grenada

Zone 10—West Central Zone of South America

Ecuador
Peru
Bolivia
Colon or Galapagos Archipelago

Zone 11—East Central Zone of South America

Brazil
Paraguay

Zone 12—Southwestern Zone of South America

Chile

Zone 13—Southeastern Zone of South America

Argentina
Uruguay
Falkland Islands

Zone 14—Western Zone of Europe

Portugal
Spain
Andorra
France
Switzerland

Belgium
Luxembourg
Saar
Germany (except East Prussia)
Denmark
Sweden
Norway
Great Britain
Irish Free State
Netherlands (Holland)
Azores Islands
Feroes Islands
Gibraltar
Monaco

Zone 15—Central Zone of Europe

Italy
Albania
Austria
Liechtenstein
Poland
Finland
Latvia
Lithuania
Estonia
Czechoslovakia
Yugoslavia
Corsica
Sardinia
Hungary
Malta
Sicily
San Marino
Danzig
Germany (East Prussia only [D calls ending in A])

Zone 16—Eastern Zone of Europe

European portions of U.S.S.R., including European portion of Soviet Russia, White Russia or Bellorussia, Ukraine, and Novaya Zemlya.

Zone 17—Western Siberian Zone of Asia

Asiatic U.S.S.R.
Ural
Kirghiz
Tadzhik
Turkmen
Uzbek
Kara Kalpak
Kazak

Zone 18—Central Siberian Zone of Asia

Buryat Mongol

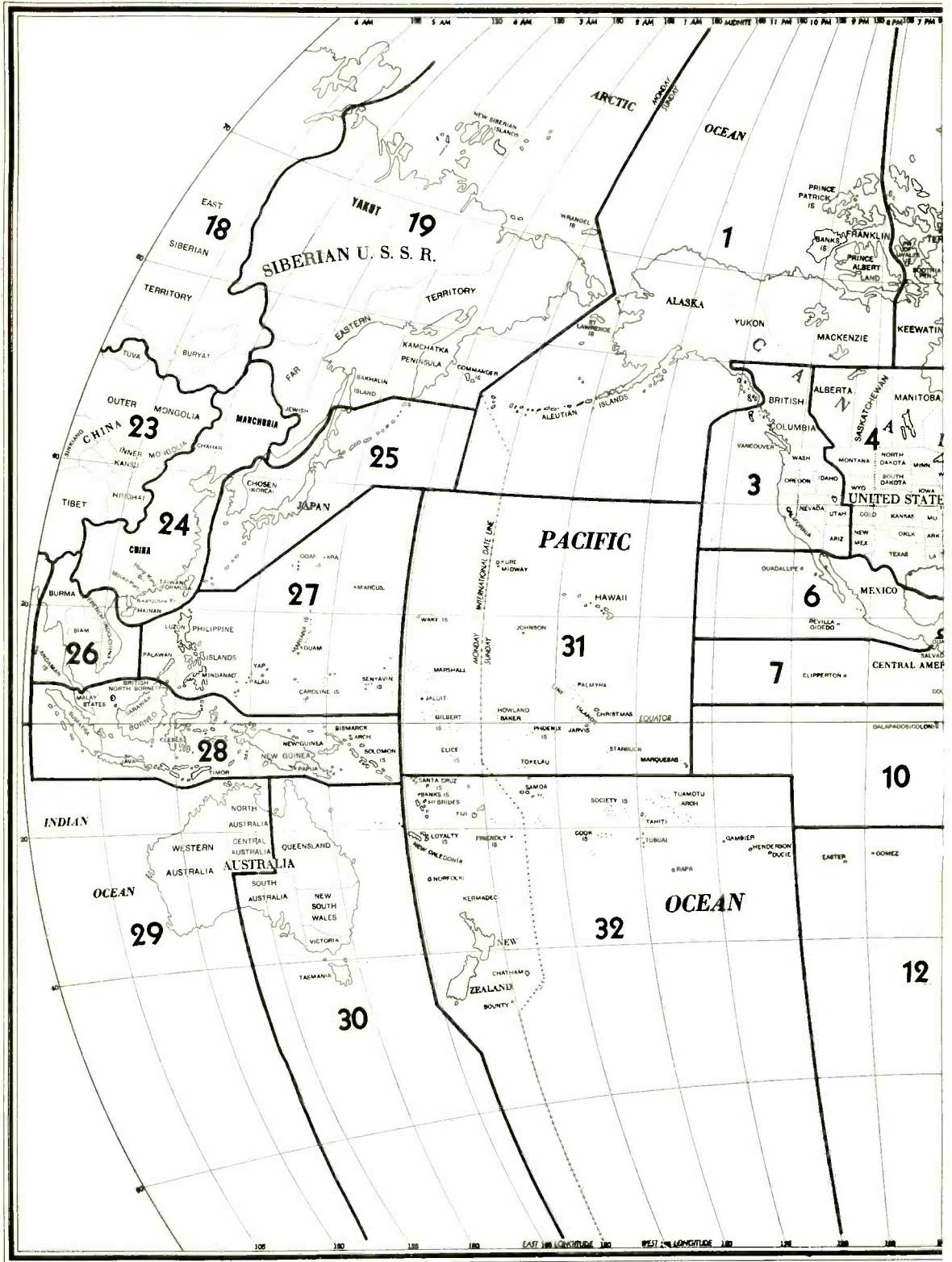

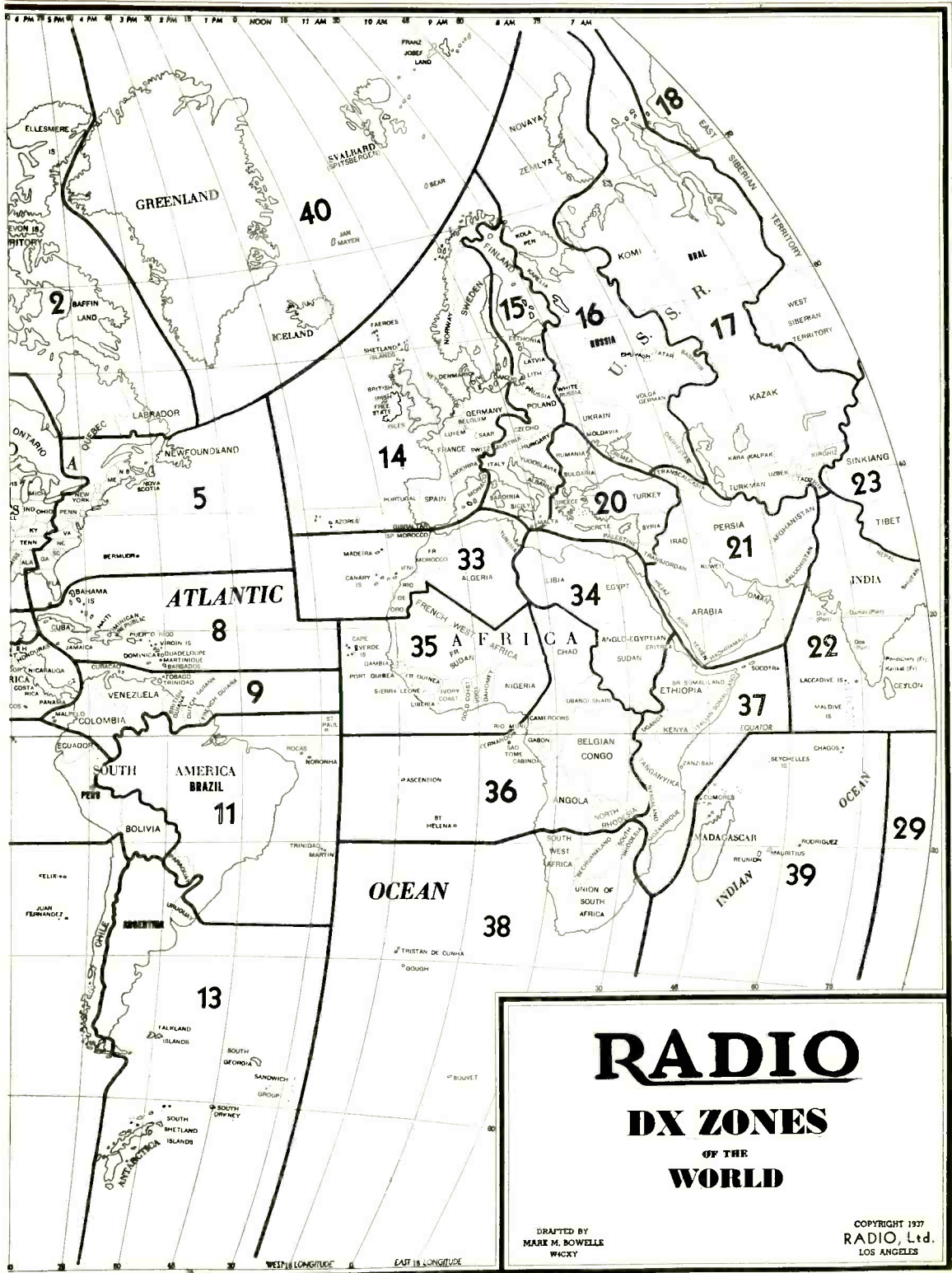

RADIO
DX ZONES
 OF THE
WORLD

DRAFTED BY
 MARK M. BOWELLE
 WACXY

COPYRIGHT 1937
 RADIO, Ltd.
 LOS ANGELES



W.A.Z. ZONE BOUNDARIES

(Continued)

- Oyrat
Siberian Krai (Eastern and Western)
- Zone 19—Eastern Siberian Zone of Asia**
Yakutsk
Far Eastern Area or Dalnevostchnyi
- Zone 20—Balkan - Asia Minor Zone**
Rumania
Bulgaria
Greece
Crete
Aegean Islands
Syria
Palestine
Transjordanian
Cyprus
- Zone 21—Southwestern Zone of Asia**
Saudi Arabia (Hedjaz, Nejd)
Yemen
Oman
Aden
Asir
Iraq (Mesopotamia)
Afghanistan
Persia
India (Baluchistan only)
U.S.S.R. (Transcaucasia only, Georgia, Armenia, Azerbaijan)
Kuwait
- Zone 22—Southern Zone of Asia**
India (except Baluchistan and Burma)
Assam
Sikkim
Ceylon
Nepal
Mahe
Maldiv Islands
Laccadive Islands
Karikal
Bhutan
Pondichery
Goa
- Zone 23—Central Zone of Asia**
Chinese Republic, following portions only:
Tibet
Sinkiang (Chinese Turkestan)
Tannu Tuwa (Tannou Touva)
China Proper (Kansu province only)
Outer Mongolia
Inner Mongolia (except Chahar Province)
- Zone 24—Eastern Zone of Asia**
China Proper (except Kansu Province)
Inner Mongolia (Chahar Province only)
Manchukuo (Manchuria)
Kwangchow
Macao
Hong Kong
Darien
Japan (Taiwan or Formosa only, J9)
- Zone 25—Japanese Zone of Asia**
Japan (except Taiwan or Formosa)
Chosen (Korea)
- Zone 26—Southeastern Zone of Asia**
India (Upper and Lower Burma only)
Siam
French Indo-China
Andaman Islands
- Zone 27—Philippine Zone**
Philippine Archipelago
Guam
Yap
Caroline Islands
Mariana Islands
Islands east of Philippines, west of Long. 163° E., north of Lat. 2° N., and south of a line from 153° E., 40° N. to 151° E., 23° N.
- Zone 28—Malayan Zone of Asia**
Malay States (Federated and Non-Federated)
Johore
Straits Settlements
Malay Archipelago, including Netherlands Indies (Dutch East Indies)
Java
Sumatra
British North Borneo
Sarawak
Papua
New Guinea (VK9)
Borneo (PK6)
Solomon Islands
Timor Islands
Portuguese East Indies
Islands between Lat. 2° N. and 11° S., and west of Long. 163° E.
- Zone 29—Western Zone of Australia**
Australia
Western Australia
North Australia
Central Australia
- Zone 30—Eastern Zone of Australia**
Australia
Queensland
New South Wales
Victoria
Tasmania
South Australia
Islands south of Lat. 11° S. and west of Long. 163° E.
- Zone 31—Central Pacific Zone**
Hawaiian Islands
Ellice Islands
Gilbert Islands
Islands between Lat. 11° S., and 40° N., and between Long. 165° E. and 140° W.
- Zone 32—New Zealand Zone**
New Zealand
Loyalty Islands
Tahiti
Fiji
New Hebrides
Samoa
New Caledonia
Chatham Islands
Islands south of Lat. 11° S. and between Long. 165° E. and 120° W.
- Zone 33—Northwestern Zone of Africa**
French Morocco
Spanish Morocco
- Rio de Oro
Tunisia
Algeria (Northern and Southern)
Ifni
Madeira
Canary Islands
- Zone 34—Northern Zone of Africa**
Libya
Egypt
Anglo-Egyptian Sudan
- Zone 35—Western Zone of Africa**
French West Africa
Nigeria
Ivory Coast
Gambia
Cape Verde Islands
French Guinea
Liberia
Portuguese Guinea
Dahomey
Ashanti
Sierra Leone
Senegal
Gold Coast
French Sudan
Togoland
- Zone 36—Equatorial Zone of Africa**
Angola (Portuguese West Africa)
Cameroons
Spanish Guinea
French Equatorial Africa
Belgian Congo
Northern Rhodesia
Cabinda
Rio Muni
Gabon
St. Helena Island
Ascension Island
- Zone 37—Eastern Zone of Africa**
Mozambique (Portuguese East Africa)
British East Africa
Kenya
Uganda
Tanganyika
Nyassaland
Ethiopia (Abyssinia)
Italian Somaliland
British Somaliland
French Somaliland
Eritrea
Zanzibar Islands
Socotra Islands
Maia Islands
- Zone 38—Southern Zone of Africa**
Union of South Africa
Southern Rhodesia
Swaziland
Basutoland
British Southwest Africa
Buchuanaland
Tristan de Cunha Island
Gough Island
Bouvet Island
- Zone 39—Madagascar Zone**
Madagascar
Reunion Island
Seychelles Island
Admirante Island
- Zone 40—North Atlantic Zone**
Greenland
Iceland
Svalbard (Spitsbergen)



RADIO
THE OPEN
FORUM

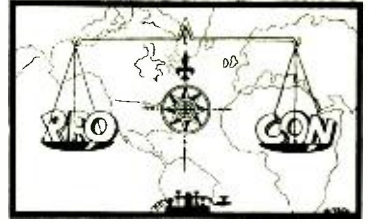

"PSE QRT ON QRO"

Sirs:

In my estimation, RADIO is the best all around publication, but I dislike the policy of "higher and higher" power. For instance, most of the pictures show some ham with a rig that most broadcast stations would look upon with envy, etc.

Someone suggested (November '36 Forum) to tax the hams for each ticket. Instead of that, I think it would be better to tax them, if at all, by the watt. A cent a watt (input, hi) a year.

If every station had a better receiver and a smaller transmitter, the same results could be obtained with less QRM and trouble.

The 160 meter band should be closed entirely to anyone without a class "A" ticket or running more than 200 watts. The way it is now, some young sprout, who has seen all the pictures of every b.c. station in the state, finally manages to get the necessary 13 w.p.m. Then, by the original method of sending for a kit of parts for a transmitter, complete, down "to the last nut and bolt" he is ready to get on 160 and cause grief to every b.c. listener in the district. Of course, the transmitter isn't adjusted correctly. The set looks OK, it is wired according to the diagram which came with it, and it "works"—after a fashion.

BEN LANE. W7FNE
AND A B.C.L.

•
IN DEFENSE OF 160

River Rouge, Mich.

Sirs:

I would like to say a word or two regarding the campaign of ridicule evidently being waged against the 160 meter band by your magazine.

During the past few months nearly every issue contains some item of ridicule or sarcasm directed at the 160 meter band, and while it is true that there exist some abuses of amateur privileges on that frequency, it must be remembered that it is primarily a beginner's band and therefore is no more to be ridiculed than one's own childhood, for after all, when you come right down to it, is there any one of us, who at some time or other, has not indulged in

some "monkey-shine" on the air?, and I say let he who is without fault cast the first stone.

Everyone who listens in on all amateurs can tell you of irregularities on any band, and let me tell you that *one* such offense on a class A band is not as excusable as *ten* on 160 meters, because all the class A fellows are more experienced and should have more sense.

Just remember that there must be a beginning to everything and that there must be some place provided for beginners while they are learning, experimenting and accumulating better equipment, and that all of this would naturally take place on some one or more of the "better bands" were we to lose 160 meters through this foolish adverse publicity, even though the possibility of such a thing taking place, since it is doubly protected by the Madrid Treaty and the North American Alliance, is very vague.

So let's get together and quit this foolish ridicule, endeavoring instead, to try and shame the comparatively few violators into better operation of their outfits rather than implying by jest that it is very common and to be expected, lest, perhaps some day, we may get public opinion so against the band as to cause us to lose this large portion of our precious frequencies so cherished as the birth-place of many a really worthwhile "ham".

E. G. CANUELLE. W8LTH.

By far and large the greatest amount of folderol, horse-play, and poor signals occur on the 160 meter band (considering the 20, 75, and 160 meter phone bands). This is unfortunate, because of the large amount of b.c.l.'s who are able to hear 160 meter phone amateurs on their receivers. RADIO at different times in the past has tried to get 160 meter amateurs to recognize their responsibility, for their own good, first by reasoning with them, then by shaming them, and then by ridiculing them. However, we didn't intend for the many fine operators on 160 to try to "wear the shoe" that was intended for the relatively small percentage of amateurs on that band who "ought to know better but don't seem to".—Editor.

•
"YAPPING"

Washington, D.C.

Sirs:

As I do not approve of your policies, you may please discontinue my subscription.

Your continued "yapping" at 160 meter phone is most disgusting. Do you realize that by publishing articles such as the one on page



46 of your June issue, you are doing all you can to make this band lousy? Any person familiar with the mechanics of modulation knows there should be at least one buffer stage between the oscillator and modulated amplifier of any phone rig; yet you go merrily on printing such articles as the one mentioned and then have the "guts" to print "The World Wide Technical Authority" on the front cover of your publication.



Also you intimate that 160 meters is a special band for drunks. I have heard more downright obscene stuff from special license holders than I have heard on 160. You are undoubtedly one of these guys that thinks he is above using his God-given voice for the purpose of communication.

You might try and follow the program of trying to promote all branches of radio instead of hammering at 160 meter phone. You could convince people you were really interested in the improvement of conditions by omitting articles that state the particular outlet is unsuited for the higher frequencies but is o.k. for 160. As the 160 meter band is closest the broadcast band, signals in this band should be even more stable.

LEO M. CONNER, W9FOO/BT3.

The transmitter referred to by Mr. Conner had such a small amount of frequency modulation on 160 meters as to be undetectable to the ear (zero beating the beat oscillator of a receiver against the carrier under modulation). Though not objectionable by a long sight, the frequency modulation was perceptible on 75 meters; hence operation on that band was not recommended. Frequency modulation is a function of frequency; a certain percentage of frequency modulation is 16 times as bad at 10 meters as 160 meters. Hence, it is quite possible for a rig to be sufficiently free of frequency modulation on 160 meters, but unsuited for use at higher frequencies due to the greater frequency modulation (measured in cycles).

Both current amateur handbooks show 160 meter phone transmitters using no buffer stage (crystal oscillator driving a suppressor modulated pentode). Also, such transmitters are available commercially, manufactured by concerns of acknowledged repute.

As this letter was addressed to the editor personally, he would like to add that operation of his station during the past year has been exclusively on 75 and 160 meter phone. A check of the log reveals that for every hour of operation on 75 meters, three hours were spent exercising his "God-given voice" on 160 meters. And ye ed. does not consider himself exactly a newcomer either, having worked 85 meter phone (not 75) of necessity because there were so few phones on 160 meters and there was no 20 meter phone band.

And before the c.w. men start the Bronx cheer, perhaps we had better add that we take an occasional dash down to Herb Becker's to knock off a few Europeans when the fingers start itching for the key.—EDITOR.

CAN YOU USE IT?

223 Prospect Avenue,
Lake Bluff, Illinois.

Sirs:

Believe it or not, you can get something for nothing in this world! I have on hand one slightly-used iron pole which is going to make one swell vertical radiator for 10, 20, or 40 meters for some wide-awake ham. I am willing to give this to anyone who has a good use for it and the facilities for erecting it. Here is the dope:

There are four sections of iron pipe, starting with 4" diameter and tapering to 1½" diam. Altogether I have approximately 35 feet, and since I have a coupling for another extension of 1" pipe, this may be run up to 66 feet if desired. I have a high-tension porcelain-bowl insulator which may be used to insulate the pole from ground.

The thing has been down in my basement for about a year now, since I have neither the time nor the space to put it up. Besides, our yard is well-stocked with 70-foot trees, which make swell antenna handles and interfere with any mast intentions I may have. Anyhow, I will give this pole to any RADIO reader who will write me and state a good reason for wanting it. If, upon hearing from me, the lucky ham is unable to come and get his present, I will ship it to him for just the shipping charges only.

Respectfully yours,
O. KLOER, W8SZB.

THREE-LETTER VK2 CALLS

Sydney, Australia.

Sirs:

Please let me take up the space of a few lines to inform amateurs in general that Australia has run out of two-letter calls in VK2 and that VK2 three-letter calls now heard are quite authentic and are not pirates. About twenty-five licensed three-letter calls are the total, I think, at the time of writing.

Having had considerable trouble in convincing W stations in general that I wasn't a pirate, I thought I would write and give a lot of fellows whom I have worked a shock. The same trouble must have been experienced by the other VK2 three-letter stations.

Evidence of the suspicion with which we are looked upon (or should I say listened to?) is in the QSL question. Out of 300 QSL cards

[Continued on Page 170]



Looking Forward into 1937

By J. N. A. HAWKINS, W6AAR

This past year has seen many new circuits, tubes, pieces of equipment, and ideas come and go in the field of high frequency communications and many of these new things should be remarked upon in passing.

It has been a year of very good dx on all the amateur bands. New w.a.c.'s are being made every day and the list of phone w.a.c.'s has about doubled. Phone stations became more quality-conscious and notable improvement towards reduction of sideband splatter has been effected through a wider use of the oscilloscope and other modulation monitors. However, so many new stations came on the air on all the phone bands during the year that as fast as one offender would get straightened out a new station would come on with some new sidebands. C.w. signals, in general, improved as more stations found the combination on the resonant filter problem. Also the number of "California Kilowatts" on the air has been reduced, although there are more 1-k.w. stations operating than there were a year ago. Directive antennas are becoming more common and over eight respectable diamond beams are in service here in California alone. This number will undoubtedly multiply during the coming year as the superiority of the diamond is now pretty well recognized.

The whole field of noise silencers was opened by Jim Lamb's "silence punch", and several applications of the limiter type of noise silencer are becoming popular. Exciters have received a great deal of attention. The Smith-Jones 6A6-53-6N7 oscillator-doubler was probably the most popular exciter of the year, but the Goodman improved tri-tet was a step in the right direction. The 6L6 is gradually being ironed out into a good crystal oscillator although it has given some trouble. Several new and simple oscillator-doubler arrangements have been worked out by Jones and Smith and should become more popular.

In the field of high-power crystal oscillators the 25-watt Reinartz oscillator has found some applications but the outstanding high-powered oscillator of the year was the 50-watt triode arrangement of W6UF, using a 35T. This 1000-1500-volt oscillator has less r.f. crystal current than a push-pull 53 oscillator working at 350

volts, and delivers a good 50 watts to a non-critical load. Even aside from the question of tube cost, the 35T oscillator has it all over the high-power pentode oscillators due to its absence of critical adjustments.

Crystal control and high power on the ultrahigh frequencies have followed the development of high-efficiency exciters and low-cost low-C transmitting tubes. Over 40 new transmitting tubes have been presented during the year, most of them being very useful for amateur purposes.

Equipment costs have steadily declined, although receiver prices took a small spurt upward late in the summer. Receivers have been steadily improved and better dials, coil switching arrangements and lower set noise have been the result. There still remains a lot to do on high frequency supers however.

For the phone man there have been almost 50 new microphones of various types. The crystal mike seems nearly to have a monopoly on amateur transmitters, but the moving coil type is gradually coming up. The ribbon mike is finding some favor but few amateurs seem to like to bother with the equalization necessary with the ribbon mike.

The development of the Doherty and Hawkins high-efficiency linear amplifiers has again upset the economics of high powered phone transmitters and the proponents of high level modulation are losing ground. However, in the field under 200 watts of carrier the development of low-cost tubes and transformers has kept high level modulation at the top without any serious competition. It is expected that controlled carrier transmitters will become more rare as the new high-efficiency linear amplifiers provide all the advantages of controlled carrier systems without the disadvantages.

The various local emergencies during the year helped to stress the need for constant development of portable and mobile equipment and several new low-cost gasoline-driven a.c. and d.c. generators have appeared on the market. Crystal-controlled 5-meter portable transmitters have appeared and are being used here and there. It will not be long until the new television services necessitate an F.C.C. ruling that 5-meter transmissions be either M.O.P.A. or stabilized oscillators.



Quarter-wave line stabilization of ultra-high frequency oscillators has gained ground. Various "rubber crystals" have made their appearance, ranging from a self-excited oscillator, up to the new variable-air-gap crystal holders for the AT-cut crystals. The Keely-Hayes conversion exciter (crystal controlled, variable frequency) will undoubtedly find wider application as its advantages become more widely appreciated.

Television

The television picture is still rather cloudy. There would have been a hundred amateurs and at least a dozen commercial stations on the air with high-definition pictures at the end of 1936 had the pick-up tubes been available. Everything else necessary for a picture is available. The only consistent television picture on the air has been the Los Angeles Don Lee picture which used mechanical scanning with the conventional scanning disc. This picture was quite well defined for a mechanical system.

Philco, Farnsworth, and RCA each has high-definition cathode-ray systems ready to go, but it seems to be somewhat of a question as to which comes first, the chicken or the egg. They don't want to put up transmitters without receivers to pick up the pictures. On the other hand, they can't sell receivers until the pictures are on the air. They are not entirely agreed upon the specifications of a standard picture, but I don't think that any standard picture chosen at this time will remain a desirable standard for more than two or three years.

We have had so many new things invented during the last year and so many new tubes, both receiving and transmitting, that it will be some time before we can really utilize all the new ideas to their fullest. It can be expected that 1937 will see still more new ideas brought forth.

Noise Silencers

There can be no doubt but that many new and simple noise silencers will appear, both of the amplitude limiting and the "silence punch" types. Several are known to be in the laboratory and they should be "de-bugged" before long. While practically all the noise-silencing schemes shown so far are limited to highly-damped and sharply-peaked impulses that do not overlap, it is not too much to hope for a silencer that will work on the electric razors and power leaks whose noise impulses largely overlap, making the "silence punch" type of silencer inoperative.

The 956 Tube

Now that we have a variable μ acorn pentode it can be expected that really good, high-gain r.f. amplifiers will be made to work in the range from 5 to 30 megacycles. Such an amplifier is badly needed for the front end of the average high-frequency superheterodyne. The use of something similar to the 956 will also allow materially increased r.f. selectivity in front of the first detector which will help to cut down the high-frequency images which are constantly getting worse as the high-frequency spectrum fills up with signals. As yet, the 956 is still too new for us to know whether it can stand high-resistance decoupling in its grid circuit as in all A.V.C.-controlled amplifier circuits. The earlier acorn tubes suffered from reverse grid current which caused the tube to burn up if the grid resistance exceeded more than a few thousand ohms. This minor bug in the acorn tubes undoubtedly will be, if it has not already been, eliminated. The 956 will be cheaper as it finds wider application.

Intermediate Amplifiers

Some signs are appearing that intermediate frequencies in the neighborhood of 1600 kc. or 2100 kc. may find some use in high-frequency supers. The newer powdered iron core i.f. transformers are capable of giving all the gain and selectivity desirable at these frequencies. The improved shielding and gain that can be achieved with the metal tubes will also help to make these higher intermediate frequencies useful. This change in intermediate frequency will tend to greatly reduce images, even on 5 meters. The growth in 5-meter supers will help to discourage the use of modulated oscillators.

Frequency Multiplication

The presentation of the Watts high-efficiency doubler circuit during the last year was one of the greatest advances in this field in some years. Now it is up to someone to show a simplified adjustment procedure that allows the fundamental and harmonic impedances to be adjusted without inter-action. Dr. Terman, of Stanford University, presented some extremely useful data on frequency multiplication and choice of bias and excitation. Someone should interpret his data in terms of actual tubes, voltages, and amateur adjustment procedure.

Antennas

1936 saw the development of several new and useful antennas for both transmitting and receiving. John Reinartz showed a very useful

5-meter receiving antenna with a very sharp discrimination against signals coming from the rear, although the front end gain was less than one decibel. This will materially help the 5-meter interference problem.

Hawkins showed a capacity-loaded matched-impedance antenna which simplified coupling of an untuned line to an antenna. This antenna also has a high-radiation efficiency due to the fact that the average antenna current is higher over a greater portion of its length than in the conventional dipole. He also showed a directive H broadside array which operates from an untuned line on two bands.

The Collins multi-band antenna is the successor to the Zepp, and is one of the greatest advances in years. A great deal of useful all-wave receiving antenna development appeared during the year and it can be expected that all-wave antennas will see considerably more development. Some day we will have an all-band transmitting antenna that operates from an untuned transmission line.

New Tubes

The past year has seen many new tubes, but outside of the RK100 gaseous-conduction triode nothing really radical has appeared in the transmitting field. The beam-power tubes such as the 6L6 and the 807 are not really new, although the beam theory only recently has been accurately measured and extended to some very useful applications. It can be expected that the beam-focussed grid arrangement will be applied to many more types and sizes of tubes in the near future.

An entirely new tube, possibly known as the Furay Gammatriode, should appear before long. This tube will find most application as a stabilized self-excited oscillator. For high-power c.w. use with a single dial to twist to change frequency, it looks at first glance as if the Furay oscillator might be one very good answer. While it can be plate modulated without frequency modulation, rather careful adjustment is necessary.

There is a possibility that this tube may be the answer to truly linear and efficient grid modulation when operating as an amplifier. It can be adjusted for any degree of either positive or negative dynamic characteristic curvature and can be made to *neutralize amplitude distortion* generated in some previous stage. It is also the theoretically perfect detector tube, as its characteristic can be shaped so that its rectification efficiency down at the lower end of

the curve (which corresponds to cut-off bias) is nearly 100%. This means that it avoids the small-signal distortion common to all forms of detectors, including diodes.

The metal tubes are coming through now with most of the early bugs worked out. A new series of 150-milliamperce heaters at 6.3 volts is starting to appear in the metal tube lines.

HIGH-RANGE CAPACITY METER

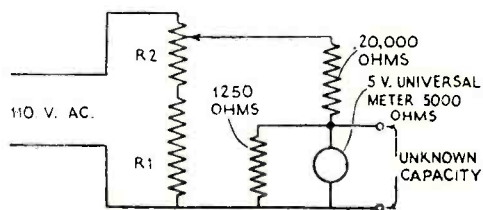

From the *Aerovox Research Worker* we take the accompanying capacity-meter circuit and calibration curve. The circuit is almost self-explanatory. R_1 is a fixed 4000 ohm resistor, R_2 is a 1000 ohm potentiometer. Both can be replaced by a 5000 ohm resistor with an adjust-

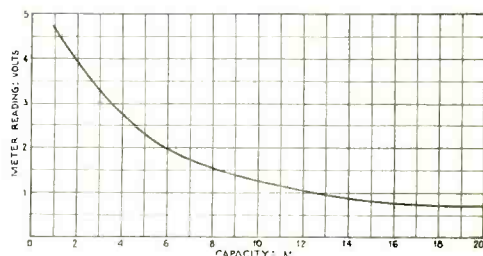

able but "clampable" tap. The potentiometer has the advantage that before each reading the meter can be set for line voltage—for instance, by sticking a 20 mike condenser across the test terminals and setting the "pot" to make the meter read 0.7 volts. However if there are too many "monkey fingers" around, the pot is always being twisted and one prefers to accept some inaccuracy in order to let the line voltage adjustment get away from the tinkerers by either putting the pot. below a panel, or else by using the tubular resistor and clamped contact already suggested.

The meter assumed is a "1000 ohm per volt" meter working on its 5 volt scale. It is of course of the "universal" or a.c.—d.c. variety.

Not all hams pawn their false teeth. One in Salem, Mass. sold his automobiles (note the plural) to get radio stuff.



The Experimental License

WHERE REQUIRED AND HOW OBTAINED

By RUFUS P. TURNER*

Any licensed amateur who chooses to conduct experiments at his station, whether he plans honest-to-goodness scientific investigation or only wishes to test a new rig, is within his right as long as the experiments are non-commercial in character and he confines his transmissions to amateur frequencies. The amateur station license, however, does not authorize any type of experimenting where money-making features are involved, whether stated or implied; the use of frequencies other than those allocated for amateur communication; or the use of types of emission not permitted to amateur stations.

For all special experimental work, the Federal Communications Commission issues an experimental class station license, and this ticket *must* be obtained whenever anticipated experiments cannot be covered by the accepted definition of *amateur* radio communication. The experimental license is not a ham ticket, though the call letters are made up with the district numeral in the conventional amateur fashion. The one distinguishing feature of the call is the initial letter, X (such as W1XYZ) which has given rise to the slang terms, X-license and X-station.

Special frequencies are set aside for use by X-stations, and the particular ones chosen by an applicant should best suit the conditions under which he plans to operate. An applicant for an experimental license is required to request one or more of these definite frequencies, as the Commission neither assigns frequencies individually nor advises applicants which would be the best ones for their particular experiments. Whatever the frequencies chosen, the applicant must satisfy the Commission that his equipment will enable him to maintain those frequencies within three-hundredths of one per cent, plus or minus. And he must show that he has precision monitoring equipment which will indicate this small tolerance.

The Experimental Service includes (1) General Experimental Stations, (2) Special Experimental Stations, (3) Experimental Broadcast Stations, and (4) Experimental Visual Broad-

cast (television) Stations. It is assumed that the average amateur of experimental bent will be interested only in the first two classifications, hence this discussion will be confined to general and special stations.

Rules 303 and 304 (Rules & Regulations of the Federal Communications Commission) define these two classes of experimentals as follows: "The term 'general experimental station' means a station equipped to carry on research or development in the radio art requiring the transmission of radio-frequency power and operating on frequencies designated by the Commission for general experimental service. The term 'special experimental station' means a station used to carry on special research or development in the radio art which, because of the nature of the experiments, requires frequencies other than those designated for general experimental stations."

The following frequencies are allocated for general experimental service: 1614, 2398, 3492.5, 4797.5, 6425, 8655, 12862.5, 17310, 23100, 25700, 26000, 27100, 31600, 35600, 38600, 41000, 86000 to 400,000 and 401,000 kilocycles and above. An applicant may request any or all of these frequencies, but he *must* be equipped to maintain the 0.03% tolerance on each one requested.

None of the frequencies is assigned exclusively to any one applicant; they are shared by similar stations throughout the country, and when interference results, the license holders are required to arrange a division of time.

Special Experimental Frequencies

Special X-stations may ask for definite frequencies other than those in the above list when the proposed owners can show that the general experimental frequencies are unsuitable for their research. Where the frequency requested is already in use by some other radio service, the applicant must make arrangements with those services beforehand in order that interference may be prevented and in many cases must file with his application statements from the other services that experimental use of the frequency is agreeable.

*W1AY-W1XDF, 159 W. Springfield St., Boston, Massachusetts.



Special Operators License Necessary

Experimental Stations may be operated only by individuals who hold commercial operator licenses of the radiotelegraph third class or higher, except in the case of stations employing frequencies higher than 30,000 kc. where an amateur operator license is acceptable.

Emissions Permitted

A1 (c.w. telegraphy), A2 (i.c.w. telegraphy), A3 (radiotelephony), and "special" types of emission are authorized under the experimental license, and the applicant may request permission to use any or all. Under the heading of *special* are included all types of keying, modulation, etc., which cannot be classified as A1, A2, or A3.

Experimental applicants may ask for definite operating hours or may request unlimited time.

Application Procedure

The prospective experimental's first job will be to apply to the Commission for a construction permit. The application, Form 401, is an eight-page document containing thirty-four questions. Herein, the applicant requests the frequency desired, hours of operation, operating output power, and emission. He must state the proposed location of the station to the nearest degree, minute, and second, north latitude and west longitude, and must list the airways and airports within ten miles of the location. He must also state the number of persons residing within one mile and within five miles of the proposed transmitter.

The type of experimental research to be carried on must be described in detail, and the applicant's own technical qualifications, or the qualifications of those he will engage to carry on the work, must be outlined. A *bona fide* statement must be made of the applicant's financial responsibility to see the work through.

Most difficult of all, the applicant must satisfy the Commission that his proposed researches will be in the public interest, convenience, and necessity. A large number of applicants are refused the construction permit because they fall down on this last requirement.

Before filling out an application for station construction permit, a study should be made of *Rules and Regulations of the Federal Communications Commission*, with particular attention to the section on Experimental Services. The booklet may be obtained for thirty-five cents from the Supt. of Documents, Government Printing Office, Washington, D.C.

Station License

The construction permit bears the call-letters of the station, frequency (s), power output of transmitter, emission(s), and hours of operation, and authorizes the building and testing of the equipment described in detail in the application. Six months are allowed for completion of the station; and if at the expiration of that period the station has not been completed, the applicant may file an application for an extension of time.

On completion of the construction and testing, application for station license is made on Form 403. This application merely certifies that the station has been completed and corresponds to the description in the application for construction permit. Should changes have been made in the original plan, these changes are detailed in the station license application. The applicant also re-affirms all statements regarding ownership, operation, control, and so forth, made by him in the application for construction permit.

Both the application for construction permit and the one for station license are filed in duplicate.

Experimental station licenses are issued for a period of one year.

Every station is required to keep an accurate log and to file with each application for renewal a report showing:

- A. Ultimate objective to be reached by experiments.
- B. General results accomplished during period of report, including references to published reports of experimental work.
- C. Technical studies in progress at time of filing of report.
- D. Any major changes in equipment.
- E. Total hours of operation.



At the Central Division Convention held recently in Chicago, a medal was presented to the guest of honor, Dr. Lee deForest, by president Woodruff on behalf of the radio amateurs in recognition of his early pioneer work on the three-element vacuum tube, probably the most important single item in the field of radio today.



One ham who distinguished himself in New England flood work was himself named *Flood*.



Iron-core i.f. transformers were used in ham supers over ten years ago.



Meet the "Mayor"

We know that a large number of our Pacific Coast readers would like to see a picture of the famous self-styled "Mayor of Moss Landing". Tom "Red" Whiteman, W6DDS, the Honorable "Mayor" of the City (?) of Moss Landing, California, is known to virtually every 160 meter phone amateur in the 6th and 7th districts. He is known by many of our eastern readers for his humorous article on tower construction appearing in the January, 1936 issue of RADIO, and for some of his sage remarks that we print from time to time in the magazine. Incidentally, Tom's reputation as a "mast engineer" is becoming widespread. He has supervised and helped build nearly a dozen towers by the "Whiteman Maimless, Brainless, Painless Method" up and down California. The 95-foot guyless tower shown in our frontispiece was built with his assistance and under his direction for one of his friends.

In the upper left picture, Tom is engaged in an argument with his inseparable friend, W6CEH ("The Down Trodden Farmer") of Santa Cruz, who is probably as well known to 160 meter amateurs as Tom. These two amateurs have undoubtedly put in as many hours on 160 meter phone as any amateur in the U.S.A. They both came on 160 meter phone several years ago when the band was practically deserted, and have averaged several hours' operation a day since. A good part of this time has been spent working each other, and we suggest that some evening when you want entertainment that you stay home from the show and listen to one of their QSO's. They both lay down a very loud signal up and down the coast.

Tom uses only 50 watts, but his antenna is stretched between two high masts and is located directly over several feet of salt water. It is a 5/16 wave Marconi, grounded to a network of radials submerged under the water and extending out a considerable distance. The Down Trodden Farmer uses a pair of plate-modulated HF-300's and an antenna over 100 feet above ground at its highest point (supported by one of Tom's towers). Needless to say, no one has trouble in hearing him.

Tom doesn't do so badly either, even with but 50 watts input. His 160 meter phone signals have been heard in several foreign countries.

In the upper right photo we see Tom standing outside the door of the "Mayor's Office". We asked him if the muzzle-loader was for ducks, but he solemnly enlightened us with the laconic remark, "Naw, B.C.L.'s". Then after a pause, "One of 'em hollered once, so I fixed him up so he wouldn't have to listen to me. That's why the population of Moss Landin' is only 47 now instead of 48." The gun also comes in handy at election time. No one has the nerve to run against him for Mayor.

In the bottom photo we see Tom hard at work (to right). Since the photo was taken he quit that job; it was too strenuous, he explained. Perhaps now you can understand why some of his friends refer to him as the "horizontal fisherman".

If you want to know about the Monterey Bay long neck clam, Tom can tell you more about them than the fellow who recently wrote a satire on them in *Esquire*. And if you are planning a new tower, give him a shout. He can give you some splendid advice. In fact, if you are a loyal Democrat, have plenty of beer in the icebox, don't "mess around on the 'high hat' band" (20 meters), and don't live over several hundred miles from Monterey Bay, he might even take a few days off and help you build it. He usually needs a rest from his strenuous work anyway, he explains. His only fee is the necessary fuel for his gas chariot, which burns 3d-grade gasoline very nicely and gets anywhere from 10 to 25 miles per gallon, "depending upon what kind of mood she's in and whether I've got enough energy to shift her out of second gear."

Tom's activities are not confined to phone operation. He joined the "Naval Preserve" as he calls it, and he explains, "They wouldn't work me on phone, so I had to learn the code."

We thought Tom was grinning when he said this. We since discovered that he was a radioman in the Navy many years ago, after which he spent some time on 40 meter c.w. before getting interested in phone.

If you like salt water fishing, drop in on Tom some time. He can tell you where they are biting and what to use to make them bite. In fact, he claims to "know some of the 'big fellows' by their first names."

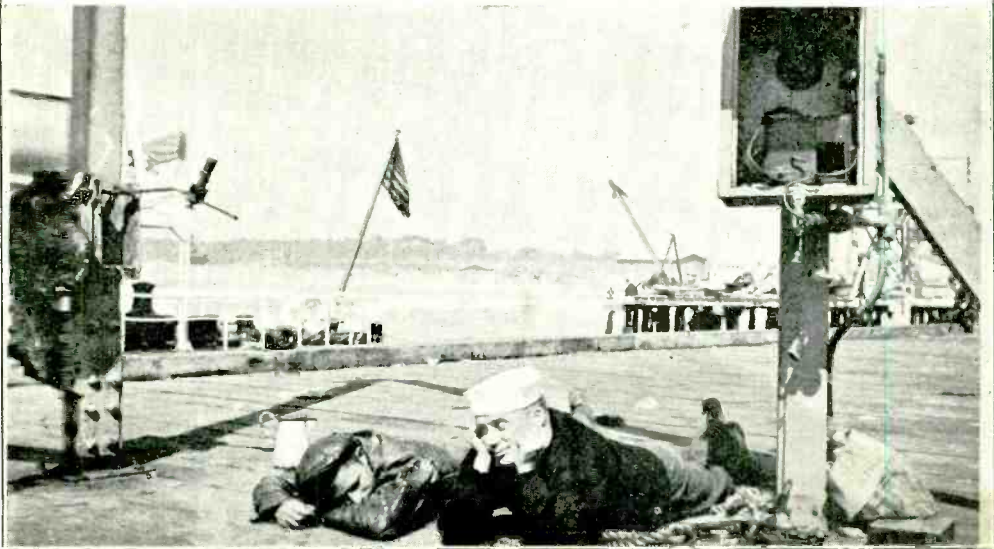

Simplified Operation by Means of Relays

Unquestionably the up-to-date amateur station should be relay operated. The use of relays in connection with radio and electrical apparatus not only provides a very desirable convenience but in many cases safeguards the apparatus and the operator against damage or injury. In this article we will endeavor to illustrate a number of uses to which relays might be well employed.

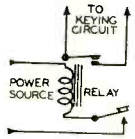

Figure 1
Keying relay.

The first application of a relay in an amateur station is for keying the transmitter. There are a number of reasons why this works out most effectively, and they are: It removes high voltage from the metal parts of the key and permits uniform characters to be transmitted, especially when a "bug" is employed. The connections for this relay are shown in figure 1. The next application is for turning the transmitter *on* and *off*. In cases of low power, where filaments and plate voltages may be applied to the rectifier at the same time in the power supply, only one relay is required, as shown in figure 2. When using this particular method, it is advisable to have a switch in the B negative or B plus supply of the transmitter power supply, so that the plate voltage will not be applied to the tubes before the filaments are thoroughly heated.

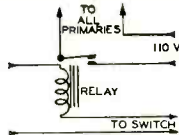

Figure 2
Simple circuit for turning transmitter "on" and "off".

By employing the system shown in figure 3 in conjunction with figure 2, we have a very satisfactory arrangement. This should be used as we said before where a low voltage power supply is employed so that there is no danger of damaging the rectifier tubes. The circuit in figure 3 primarily opens the B negative circuit right at the power transformer secondary. In addition, we have shown how the receiver may be operated in conjunction with this arrangement to permit *stand-by* for *rapid change-over* during communication. Two relays are employed here—one to disconnect the B minus center tap of the high-voltage secondary, thus turning off the power to all stages in the transmitter, and another relay to turn the receiver on by connecting the center tap in the high-voltage secondary of the receiver power transformer; this is for *standing-by*. In order to transmit, merely make contact with the *stand-by*

switch; this turns the high voltage on to all tubes in the transmitter and at the same time turns the receiver off.

Where higher power is used it is necessary to heat the filaments for a period of at least 15 or 20 seconds and in some cases a few minutes before plate voltage is applied. This may be accomplished with *time-delay* relays or more simply and more economically by the system shown in figure 4. Here a single double-pole, single-throw relay is used to turn on the filament transformers. The other pair of contacts on this relay complete the circuit for the high-voltage relay. Thus, when the plate switch makes contact the primaries of the high-voltage transformers are thrown on and we are ready for operation. If the plate switch is pulled open, only the filaments remain on; while if the filament switch is pulled open while the plate switch is closed, they all go off at the same time, which is a reasonable measure of safety. The only danger is in throwing the filament switch on when the plate switch is already closed. The

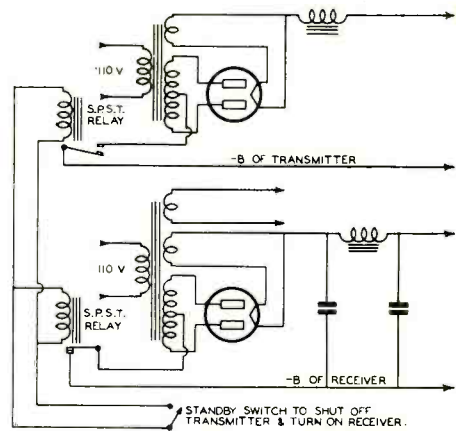

Figure 3
This system provides rapid change-over from transmit to receive and speeds up operation.

operator should make sure that *this is never done!*

The entire group shown in the four different diagrams represents a complete installation. A combination for relatively high voltage would be figure 1 for keying, figure 3 for stand-by and figure 4 for starting the station. In the case of figure 4 for relatively high voltage power supplies, where separate filament and plate trans-

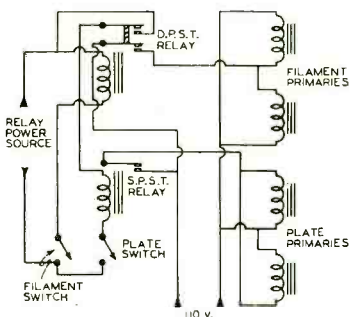

Figure 4

How two relays are employed in a high-voltage power-supply, using separate transformers for plates and filaments.

formers are employed, *break-in* can be accomplished with the plate switch, merely by disconnecting the high-voltage primary. In this case, the field of the relay operating the receiver would be connected in parallel with the field of the plate relay. Of course, if a number of separate power supplies are employed, then the number of relays will have to be increased. This will depend upon the particular station layout. If relays are installed, there is no doubt that they will prove the most valuable accessory the operator ever employed.

Modulation Notes

The "surging" plate current pulled by a pair of class B modulators does lots of funny (and sometimes rather disconcerting) things. If the same plate supply is used for both the modulator and modulated stage, we can tell absolutely nothing about our modulation percentage from the degree of activity of the antenna ammeter. A pure, steady, voice tone producing 100% modulation would (symmetrical modulation envelope and no carrier shift) ordinarily drive the antenna current up about 17%. But at 100% modulation the increased plate current to the modulators causes the plate voltage to drop from 5 to 15 per cent (depending upon regulation). So, instead of rising 17 per cent, the antenna ammeter either goes up just a hair on a sustained 100% modulation tone or stands still. Willie Wizeguy takes a squint at the antenna ammeter and tries to whistle it up 20% or so. It goes up only 5%, and, horrified, Willie cranks up the gain in an attempt to "bobulate" 100%. As he winds up the gain and modulates harder, the plate mils on the modulator kick up more, and the plate voltage drops

more and more on a whistle. When he finally runs up the gain enough to enable him to whistle the r.f. current up 17%, the plate voltage on the final has dropped probably 20% or so during the whistle, the negative peaks are being clipped over about one quarter of the audio cycle, the positive peaks hit 547%, the modulator tubes groan in agony, the harmonic distortion is around 35%, and the signal takes up half the band on a good super or two-thirds of the band on a poor one. Willie notes with satisfaction that he is now modulating "100%" and proceeds to clutter up the band with a CQ.

Great is Willie's indignation and disbelief when someone with a "scope" informs him that he is unable to give Willie the dope on the pattern of Willie's modulation because it "flies clean off the screen".

If a modulator is a small one (in comparison to the modulated stage) or if the modulated stage has not a super-abundance of excitation, Willie may be unable to make the antenna current climb 17% regardless of how hard he yells. But the peak-clipping and harmonic distortion will be there just the same, causing a fuzzy and broad signal.

What's to be done about it? First, improve the regulation of the power supply that feeds the modulators and modulatee. If the plate voltage varies more than 6 or 7 per cent under modulation it shouldn't be used for class B anyhow, unless you are willing to sacrifice quality. Second, do not attempt to ascertain your modulation percentage by the increase in antenna or tank current. Either check it on an oscilloscope or rig up a "negative peak clipping indicator". Really these methods should be used even when separate power supplies feed modulator and modulatee, but their use is doubly important when a single supply is used.

Believe it or not, *QST* once ran a three-quarter page ad offering *RADIO* and *QST* in a combined subscription plan! "Every progressive radio experimenter," said the ad, "Should read both magazines regularly."

If you haven't already seen one, we suggest you get yourself a copy of *Kenyon Engineering News*. It has many items of interest to radio amateurs, and contains many useful tables and charts.

One big-shot advertiser in the hazy past called hams, *radiotics*.

A 66 Foot Vertical Duralumin Radiator

By E. H. CONKLIN, W9FM

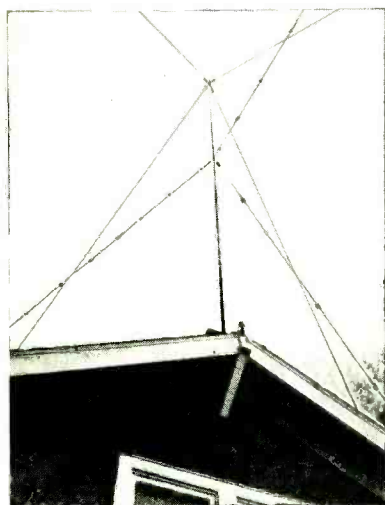

The vertical duralumin radiator of W8ZY (photo retouched to show detail).

A year ago we called upon Karl Duerk, W8ZY, and became interested in his 39 pound duralumin mast which, placed upon the house, reaches up to the 96 foot level, and acts as an all-band antenna. Recently we made a special trip to Defiance, Ohio, just to take another look and obtain a description, which is presented below. If you are interested in its operation rather than the construction, skip over the following details.

Material

The bill of material calls for 70 feet of 0.120 inch wall 40,000 pound tensile strength "dural" tubing. The wall is slightly less than $\frac{1}{8}$ inch and therefore tubing in quarter-inch steps will telescope together. The five 14-foot lengths have the following *inside* diameters: 2", $1\frac{3}{4}$ ", $1\frac{1}{2}$ ", $1\frac{1}{4}$ ", and 1". The total weight without the guy wires is 39 pounds, and it can literally be lifted single-handed. A telephone call to the aluminum company revealed that tubing of this strength is relatively inexpensive compared with heat-treated materials. It is described as "52 S.H." In quantities less than 25 pounds of each size, the cost runs around 61c a pound for these diameters. The duralumin therefore will run to about \$25.00.

The mast is supported on a large multi-skirt insulator (who said "pop bottle?") because

high voltage will appear at the bottom when used on 40 meters and below. Good insulators should be used where the guy wires connect to the mast, because these must handle the strain as well as the voltage. Duerk uses the twelve-inch Johnson type. Other guy wire insulators can be the inexpensive "eggs" which involve looping the wire through so that a broken insulator doesn't let the mast down on somebody's head. Number 12 galvanized iron wire is used at the upper guying position, while only no. 16 is necessary for the lower guy wires.

The upper guy wires are attached to a pipe flange which has had its threads turned out to slide on the $1\frac{1}{4}$ inch section, resting on the $1\frac{1}{2}$ inch section (inside diameters). Fittings of this sort without internal threads are probably available from brass supply or boat supply houses—or whoever supplied the rails before bars went modernistic.

The sections are bolted together with $\frac{1}{4}$ inch drill rod, threaded at the ends and cadmium

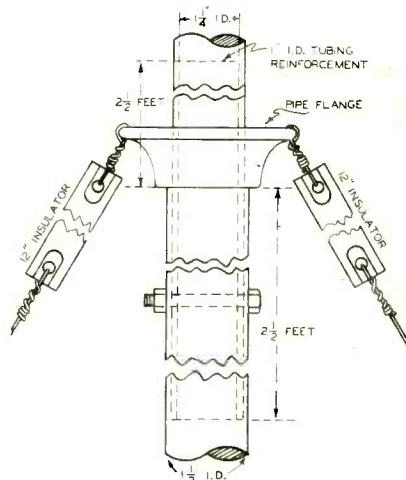

Figure 1

Showing construction of joints and also the method of fastening the top guys to the pole. The threads on the pipe flange are turned down so that it slips on the upper section of tubing. Because of the guying at this point, the joint is further reinforced by a short length of 1" inside diameter tubing slipped inside the $1\frac{1}{4}$ " tubing.

plated. A single bolt at each joint is sufficient because the outer tube is squeezed against the inner one sufficiently to remove the "shear" strain upon the bolt.



And lastly—get a cork to plug the top to keep rain water out.

Construction

It is difficult to distinguish between the construction of the pole and the operation of raising it. The only real construction job is drilling four holes for the bolts. If this is done beforehand, the bottom two sections can be slipped together ten inches, and the bolt hole drilled through (see figure 1). The same overlap is used at the second and fourth joints. The third joint, however, carries the strain guys. In this case the overlap is made $2\frac{1}{2}$ feet long, and in addition a four-foot piece of the 1" section is slipped inside of the $1\frac{1}{4}$ " section to strengthen the joint.

The total length above the base insulator at W8ZY is just 60 feet, the visible length of each section, beginning with the bottom, being 14', 13'2", 13'2", 11'6", and 8'2". Originally the whole top section was used, the total length being 65 feet, but the top swayed around a little more than was thought safe with the upper guys 25 feet below the top. If the full half-wave length is desired on 7 Mc., it might be better to start with a 20-foot section of the two-inch tubing, thus raising the upper guy wire position, keeping it twenty feet below the top.

If a vertical rod is pivoted at the base and is guyed two-thirds of the way up only, it can

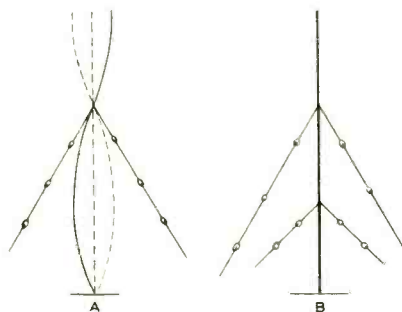

Figure 2

"A" shows mechanical vibration when guyed $\frac{2}{3}$ of the way up (free top and pivoted base). "B" shows how a set of lower guys stop the vibration.

vibrate mechanically with a "half-wavelength" below the guys and a "quarter-wavelength" above. By placing the second set of guys one-third of the way up, the possible vibration is reduced to almost nothing. The top will weave about as much as two or three inches, but no serious bending has been observed.

The guy wires can be made ready. In the

W8ZY mast, the upper guys are broken into $6\frac{1}{2}$ foot lengths, the lower guys into $4\frac{1}{2}$ foot lengths. They can be attached to the substantial insulators located just at the flange. Four guys at the upper position are recommended.



The Ohio license tag of W8ZY, purely coincidental of course. (Ahem.)

One way to support the high-tension insulator on a slanting roof is to make a box to fit over the peak, bottom side up, requiring no nails in the roof. This box can be large enough to bridge across two rafters in the roof. (See figure 4.)

If you are going to put the pole on top of a peaked-roof house, a handy gadget is recommended. Duerk built up a little double platform from 2 x 8 planks and some 1 x $\frac{1}{4}$ inch iron bar (see figure 3). The perforated strip used to support pipes from basement ceilings probably could have been used. The iron bar is bent to conform with the roof angle at the peak, and bolted at the ends to triangular pieces of the plank which support a narrow horizontal platform on each side of the peak. If the mast is to be right at the edge of the roof, don't fix things so that the mast grows up through the center of the platform unless you have arranged to take the platform apart to remove it. One dodge is to move one of the iron straps in from the end of the planks so that both straps will be on the same side of the mast.

Wood can be used in the construction of the platform in place of the strap iron, or two ladder-like arrangements can be built and bolted together so that one ladder goes down one

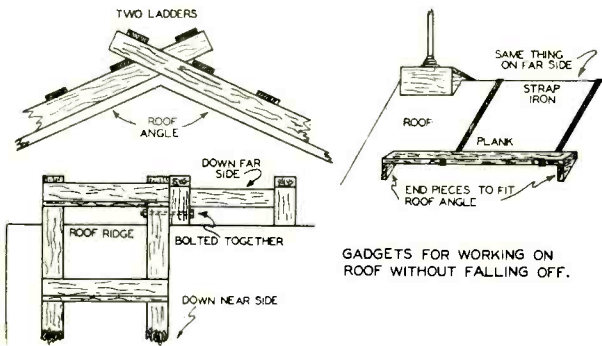

Figure 3

side of the roof while the other, bolted to it at the top end, serves as a counterweight down the other side. (See figure 3.)

Raising the Pole

A scaffold was used the first time this mast was raised. When it was taken down, shortened, and replaced, the "handy roof gadget" was used. With men standing by the upper guys and two on the roof, the whole thing was lowered, rebuilt and raised in about an hour.

The first thing to do is to cork the top section and set it on end. Then the next section can be bolted below, working over the edge of the roof. The flange is then slipped on and the middle section is bolted on and passed up hand-over-hand. The fourth section and sway-guys are next attached—half way between the strain guys and the bottom—followed by the bottom section. Some help will be needed from the guy wire attendants on the ground by way of keeping the pole vertical after the third section is attached.

While ordinarily a mast of this height would require numerous sets of guys and a large area over which to stretch the guy wires, the fact that the upper guys are only two-thirds of the way up reduces the space requirements. Duerk has one guy attached to the house only 30 feet from the base. The other three are fastened to convenient trees and posts from 30 to 50 feet from the base.

The Feeder

At W8ZY, the total length is now only 60 feet above the peak of the house (6 feet shy of a half wave on 40 meters) and therefore the "feeder" runs as a single wire for an additional six feet from the bottom of the pole before the second feeder starts. On most bands, the feeder system is switched to a pair of condensers and

a coil, the latter being link coupled to the proper transmitter. On ten meters there was a shortage in the condenser supply so the coil was placed in the feeders without a tuning condenser, and the turns squeezed together until resonance was obtained. On 80 meters, a horizontal wire could have been attached to the second feeder, or the whole mast plus feeder could have been worked against ground. But Europeans have been raised just by tuning the feeders and antenna, allowing the feeders to become unbalanced (same as using a 40 meter "zepp" on 80).

Operation

Our first impression of the operation of this mast as an antenna was that it would be fine on 7 Mc. but that because it is a full wavelength



This will give you an idea of how the radiator "sticks its head above the landscape" (photo retouched to show detail).

on 14 Mc., the higher angle of radiation might reduce its effectiveness. We had visions of center-feeding it to get 2 db. gain and concentrated low-angle radiation. However, the absorption of radiation from the bottom half may be greater than from the upper half which is in the clear above houses and trees, so that the pat-

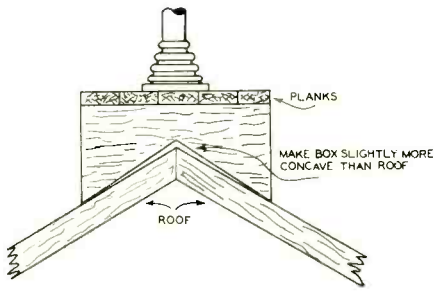

Figure 4
Box used as base of mast at house peak.

tern may not be as unfavorable as might be expected. W8ZY *does* get out very well on the 14 Mc. band, however, and gave us this illustration:

A chap from Akron, Ohio, recently moved to a rubber plantation in Liberia, and put up a rig to keep in touch with the family. He is using the call UN2A (14,404 kc. with a real signal!), and a beam pointed across the U.S.A. W8ZY has plenty of competition with other 1 kw. rigs on 14,397 kc., yet UN2A says that other R9 signals cause no trouble even when copying several hundred words of news from home—with only two exceptions: WILZ and W6CXW.

On ten meters, the pattern presumably has several lobes, including some useful ones at low angles. With 250 watts input to a T-55, W8ZY seems to work plenty of dx, with good reports.

On receiving, signal strength is better on all bands than on anything else that has been in use. On the highest frequencies, ignition noise is worse than on a horizontal doublet, but the better strength justifies the use of the single antenna for all purposes.

The field strength within the house is rather strong, making it necessary to use some by-pass condensers across lights. That would still happen, probably, if a horizontal antenna were used over the house. If a short, husky pole is available in the yard, the mast could be mounted on that, away from the house.

No one is making claims that this antenna is better than stacked doublets, beams, etc. Yet it is up in the clear where some power can be radiated above trees and houses, it can be used on several bands, and it is not as unsightly as a pair of poles with a lot of guy wires all over the lot. And remember, if you are cramped for room, you can always go *up*.

THE DECIBEL

The human ear is less sensitive to a change in volume of sound as the intensity of the sound increases. Thus a thunderclap might represent several million times the audio power of a watch ticking, yet your ears can stand the tremendous volume of thunder and at the same time detect a watch ticking. Scientists have discovered that the ear's response to changes in sound intensity follows mathematical rules.

Relative audio powers may be expressed as power ratios. For instance, if the output power of an amplifier is 10 watts and the input power is 1 watt, we have increased the power level of the signal through the amplifier 10 times. The output power divided by the input power gives the ratio of signal increase.

But our ears do not respond according to power ratios. So we have to change these ratios to sound units or decibels. Don't be frightened by this term decibel—it is no more difficult to handle than ohms, watts, or any of the other terms you use every day in radio service. An easy method of thinking in decibels is expressed thus: In terms of power gain in an amplifier—

A power ratio of 1 is a 0 db gain

A power ratio of 10 is a 10 db gain

A power ratio of 100 is a 20 db gain

A power ratio of 1,000 is a 30 db gain

A power ratio of 10,000 is a 40 db gain

A power ratio of 100,000 is a 50 db gain

A power ratio of 1,000,000 is a 60 db gain

A power ratio of 10,000,000 is a 70 db gain

Studying this series of relations, you can quickly see that the number of times 10 would have to be multiplied by itself equals the significant figure of the decibel gain. But each decibel gain figure is 10 times the significant figure. Therefore, any gain ratio even though it is a billion, which is 10 multiplied by itself 9 times, needs only to have the 9 multiplied by 10 to secure the decibel gain which in this case would be 90. Those who prefer the logarithmic method of calculating decibels use the formula:

$$\text{Db} = 10 \text{ Log}_{10} \frac{\text{Power output}}{\text{Power input}}$$

[Reprinted with permission from the THORDARSON TRANSMITTER GUIDE]

◆
Electrodynamometer is the longest single name used to any extent in radio.

◆
A conductor with unit resistance also has unit conductance!

The Evolution of a Vacuum Tube

By W. W. SMITH, W6BCX

[This bit of nonsense was written in 1934 and first appeared in the January, 1935 issue of RADIO. In response to a number of requests it is reprinted herewith, this time with illustrations. We ask forbearance of R.C.A., Eimac, Raytheon, and Amperex. After all, it is all in fun.]

Sales Manager of Novacon Inc. informs Chief Engineer that what the hams need is an addition to the Novacon line of electronic devices that will fill the gap between the NG-210 and



"... stays up all night trying to decide ..."

NG-211 transmitting tubes. Chief Engineer stays up all night trying to decide whether to first build the tube and then name it, or to name the tube and then build it. After going into conference with second pint of Old Crow¹ gets inspiration to call new tube the NG-210¹/₂. Office boy remarks that designation is very fitting, but reminds C.E. that Feebeltron has a tube called the FB-479¹/₂, and confusion might therefore arise because they sound so much alike. Suggests to C.E. that they call the tube the NG-73.

For rough draft of proposed tube, design department uses pantograph on drawing of NG-210, and brings plate lead out top of envelope.

Office boy takes home first experimental model of tube and reports after trying it in his TNT that the thing got "pretty red" with 93 watts input and the key held down. Chief had a TNT once, and found efficiency to be 47 per cent, so with 93 watts input the tube must have been dissipating 50 watts, he figures. Office boy discloses that his milliammeter has bad habit of sticking and getting loggy; therefore figure of 93 watts should not be taken too seriously. C.E. replies not to worry about that, because he was not sure of the accuracy of the ratings on the carbon lamps he used for dummy

¹An old favorite of both receiver and vacuum tube manufacturers.

load, and only guessed at normal brilliancy anyhow. So maybe a TNT was 69 per cent efficient instead of 47 per cent.

Janitor asks C.E. why he doesn't run static test on the tube to determine how much it will dissipate without getting too red, instead of fussing around with TNT's. C.E. shuts him up by giving him second experimental tube to take home with him to play with, and then rushes off to lab to see about the matter of static inputs. Janitor reports next morning that tube gets fairly blue at 1250 volts.

Advertising department releases advance data on new NG-73 along with tentative ratings: Plate dissipation (max.) 50 watts. Plate voltage (max.) 1250. Oversupply of 210 filament stock results in tube having 1¹/₄ amp. filament, 15 volts to give necessary watts emission. Shop foreman's son reports that he had 1500 volts on one for 5 minutes and it didn't blow up or go soft, so rating is changed to 1500 maximum.

Charlie Perrine writes in and says that he obtained 231 watts output from an NG-73, with a note that if grid leads were brought outside so a Hamperex HF200 driver could be used without the NG-73 flashing in the base, and the tube were pumped harder to allow 2800 volts on the plate instead of the 2200 he was using, it would be possible to get 239 watts output with-



"... after going into conference with second pint of Old Crow ..."

out exceeding the dissipation rating. Chief Engineer after reading letter five times announces that he has, after much scientific research, decided to scrap current design and change mechanical construction. He carries the idea one step further and brings not only the grid lead out the side, but also the filament leads out the other side. Notices that pins on base are not connected to anything, so decides to throw base away. Discovers difficulty of mounting tube which has no prongs, so decides to put base back on.

Remembers about remark that tube should be pumped harder. Makes memo to put more "getter" in the tubes and increase the size of the envelope to allow cool spot of glass at bottom of tube for gases to collect on. President sends him memo never to use a preposition to end a sentence with.

Tube now handles 2800 volts without celebrating Fourth of July. Assistant Engineer notes new size of envelope and remarks that it is now large enough that if cooling flanges were put on the plate, the dissipation rating could be raised to 75 watts. "Improved" NG-73 makes its debut, sporting new corrugated-carbonated plate with cooling flanges giving the anode the appearance of a burned drug-store waffle wearing flippers. Data sheet states 300 watts input now permissible in high-efficiency circuits.

Skroo Loos, W5NUT, takes antenna off his Perrine rig to show visitors how he can draw off a 7-inch arc, and blows NG-73 through roof. Writes to factory saying tube sure enough "NG" all right, and asks why bother to put the "on" on "Novacon"? Does not think it necessary to mention small matter of plate voltage of 3200 and removal of antenna.

W6AM writes in that tube gets very hot with 300 watts input, which should be permissible according to ratings. Does not notice that he has mixed up coils on trick Don Wallop coil-changing scheme and is using 20 meter coil on 40 (resulting in very high "C"), as he has become far-sighted from trying to point out to visitors the trade mark on "Q" antenna atop his tower.



"... even if it were good he wouldn't like it..."

W4SOS writes in plate ready to melt at 250 watts input, but neglects to mention that tube was running self-excited on 11½ meters. After mailing letter finds that the tube wasn't on 11½ meters after all, because the tube wasn't even oscillating. Decides to keep discovery to himself and lets letter ride.

W7RAZ forgets to remove shunt from milliammeter, and writes very derogatory letter about tube being over-rated. Visiting ham notices shunt and calls it to his attention, but RAZ

remarks that the tube probably isn't any good anyhow, and that even if it were good he wouldn't like it.

Adjustment department gets tired of replacing tubes and answering complaints, so advises engineering department to make the tube huskier so that the hams can run 300 watts input, and not just 300 Perrine watts input.

Plate is made larger to handle more heat, and spacing is increased to raise breakdown and keep interelectrode capacity at approximate rated value. Proving laboratory finds tube okay except plate resistance now twice original value, which is corrected by putting in a huskier filament, now drawing 4 amps. instead of 1¼ amps at the same 15 volts.

"... staff compliments itself on new tube..."



News leaks in through grapevine that Braytheon and Earmac are about to release a class B audio tube with a transconductance of 4237 as compared to 3879 mmhos. for the NG-73. Chief decides that too much plate is hiding from the filament. Designs phantom grid structure to cut down shadow and raise mutual conductance. Research department brings in tube in which no grid can be seen at all. C.E. compliments research department, and then notes they carried things a bit too far by leaving out grid altogether. New Novacon high voltage rectifier for cathode ray equipment announced; appearance is suspiciously similar to the NG-73.

Chief decides to quit playing with ghosts and leave grid structure as originally planned, and to raise mutual conductance by putting in still more filament. New 8 ampere filament radiates so much heat that envelope melts with no plate input. Envelope glass changed to Stonex.

President's son decides to build himself a ham rig using low level modulation with a pair of NG-73's as linear amplifier. Because of comparatively low efficiency, finds that output is limited by plate dissipation long before maximum allowable plate voltage and plate current are reached. Instructs dad to instruct C.E. to put flanges on the cooling flanges to increase dissipation rating. New NG-73 is announced, more suited to low-level and grid-



modulation as dissipation rating has been raised from 135 to 165 watts, without change in other characteristics.

Letter from Perrine states that at 4600 volts he finds it possible to run 2800 watts input to a single NG-73² without the plate getting much more than a vivid red if keyed with light enough dots.

Engineering staff compliments itself upon new tube, and celebrates occasion by opening case of Old Crow. President opens letter from field man advising him that what the hams need is a tube that will fill the gap between the NG-210 and NG-211. President has idea for new tube. Chief Engineer has delirium tremens.

SIDEBAND SPLATTER

The Federal Communications Commission now requires that all amateur phones operating in the bands below 30 Mc. not be modulated in excess of their modulation capability. The modulation capability of a phone transmitter rarely exceeds 90% modulation and the maximum *capability* of many amateur phones is below 70%.

By modulation capability is usually meant that percentage of modulation above which the transmitter begins to generate spurious sidebands which may extend out 50 kc. or more on one or both sides of the carrier frequency. These spurious or extraneous sidebands are generally termed "sideband splatter". They cause a tremendous amount of unnecessary QRM to stations working on adjacent channels and can sometimes be heard thousands of miles. These same extraneous sidebands also can cause bad local QRM to broadcast listeners.

One source of sideband splatter is *carrier shift*. Carrier shift has nothing to do with frequency modulation or a shifting of the *frequency* of the carrier. Carrier shift describes a shift in the *average* amplitude of the carrier, which is supposed to remain constant during modulation. Carrier shift almost always can be identified by a change in the d.c. plate current drawn by the final amplifier, whether a plate modulated class C stage, a grid modulated stage or a class B or BC "linear" r.f. amplifier. Carrier shift can occur at *any* percentage of modulation and is not necessarily associated with overmodulation. In fact, a transmitter can be considerably overmodulated without any noticeable carrier

shift being present. The best indicator of carrier shift is a diode linear rectifier consisting of a 30 tube or equivalent used as a diode (grid and plate tied together) and a 0 to 1 milliammeter. The diode rectifier is placed in series with the meter which indicates the average rectified amplitude of the carrier. If carrier shift is present the meter reading will change slightly during modulation. If the meter reading increases there is *positive* carrier shift. If the meter reading decreases there is *negative* carrier shift present. Note that the meter reading will usually, *but not always*, vary when the carrier is overmodulated. The same holds true for the d.c. plate current to the final amplifier. If there is only enough r.f. grid excitation to the class C stage to enable the positive modulation peaks to go to 100% modulation, and not beyond, then both the positive and negative peaks will be cut off and little or no carrier shift will result. This explains how some stations can consistently overmodulate yet the operator can truthfully maintain that the plate current to the final amplifier remains absolutely constant.

SOLDERING IRON PILOT

An excellent pilot light for a soldering iron may be made by inserting a small resistance in series with the power supply line to the soldering iron outlet. Across this resistance a standard 2½ volt pilot light bulb may be connected to indicate when the soldering iron is connected. The size of the resistance is determined by the power consumption of the soldering iron. In the case of a 100 watt iron, which draws approximately 1 ampere of current, a resistance of 2½ ohms capable of passing 1 ampere will cause a voltage drop of approximately 2½ volts.

A short section of wire from an old radio filament rheostat or from an old electric toaster will serve as a resistance. The wire may be wound on a strip of bakelite or on a round pencil, from which it may be removed in the form of a spiral spring.

The drop in voltage will not seriously cut the efficiency of the soldering iron but does provide ample current for the pilot light. The pilot will only light when the soldering iron is drawing current through the circuit. (See diagram.) By experimenting with various resistances, it is possible to make simple pilot lights for flat irons, toasters, percolators, and other household appliances, which may otherwise be left connected for a long time.

²Working into a dummy antenna.

Radiotelephony for the Newcomer

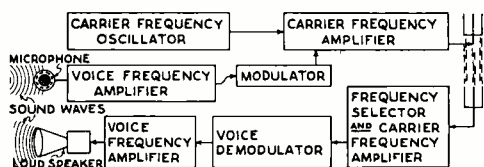

Figure 1

There can be no doubt but that most beginners in amateur radio today are attracted by the idea of voice communication. Formerly the whole idea of communicating at all was so new to most people that it made little difference whether the method utilized voice or the Continental code. Today, however, the widespread sale of all-wave broadcast receivers has brought an entirely new crop of beginners into the fold who have listened to amateur phone stations through their all-wave receivers. The age of this type of newcomer averages probably 10 to 12 years older than the beginner of only a few years ago who usually consisted of a boy of school age of a mechanical turn of mind. This older type of beginner finds learning the code somewhat more difficult than the younger beginners did, which also partially accounts for the wider interest in phone among beginners today.

Improved Phone Technique

However, the principal reason for the wider interest in phone among the beginners is undoubtedly due to the vast improvements in phone technique which have occurred in the last few years. It is a fairly simple matter to construct a 25 to 50 watt high quality 160 meter phone today for less than a hundred dollars. Such a phone transmitter can be purchased ready for use for about two hundred and fifty dollars. Good superheterodyne receivers are also available at around fifty dollars or less. Another attraction to the use of phone lies in the fact that it is an activity that can be more or less shared by the y.l.'s of the family.

The fundamentals underlying the operation of a phone transmitter are not particularly complicated when analyzed in their logical order.

Microphones and Voice Frequency Amplifiers

A microphone is a device which transforms the successive compressions and rarefactions in the air caused by the vibrations of the vocal

cords of the speaker's throat into a pulsating electrical current. The pulsations, or more strictly, the variations in the electrical output of the microphone, are usually quite small and thus must be amplified before they can be used. This process of amplification takes place in one or more vacuum tubes connected in cascade. A vacuum tube amplifies by reason of the fact that a small electric current applied to the control electrode (grid) causes the controlled electrode (the plate) to release an exactly similar, though magnified, electric current to the output (load) circuit of the amplifier. If the output of the voice frequency amplifier were suitably connected to a loud speaker or telephone receiver the electrical impulses would be turned back into variations in air pressure which constitute audible sound. Thus far we have described a telephone circuit essentially similar to the one between New York and San Francisco, for example.

It might be thought that merely by amplifying sufficiently the voice currents and then applying them to an antenna might be enough to allow voice communication by radio. This is not the case for several reasons. It is known that the range of voice vibrations runs from about 50 to 10,000 vibrations per second. Thus the electrical equivalent of voice vibrations is composed of an alternating electric current whose frequency of alternation is in the same range (50 to 10,000 cycles per second). Before anyone can hear a radio wave it must be radiated from the transmitting antenna into space. It has been determined that the efficiency of radiation from a transmitting antenna increases as the frequency of the electric current increases, and is far too low to allow any appreciable radiation at the voice frequencies. Also, the size of the transmitting antenna goes down as the frequency goes up and therefore the cost of an efficient antenna becomes less as the frequency of the radiated electricity goes up. Thus it becomes necessary to change somewhat the original voice frequencies which were impressed by the microphone on the voice frequency amplifier into a considerably higher frequency in order that enough electrical power may be radiated from the transmitting antenna to be picked up by the distant receiver. Instead of directly changing the voice frequencies to a higher frequency by some process of frequency



multiplication which would involve many difficulties, a much simpler process is used.

A constant, high frequency alternating current is generated by an oscillating vacuum tube. The frequency of oscillation is usually that which it is desired to radiate from the antenna and might be, for example, 1800 kilocycles, which is in the 160 meter band of amateur frequencies. Then the amplified voice frequencies are mixed, by the process known as modulation, or heterodyning, with the 1800 kc. carrier so that the amplitude of the 1800 kc. carrier wave is varied up and down about an average value in exact accordance with the variations in sound pressure that the operator's voice impressed on the microphone. Thus the 1800 kc. carrier wave is said to be modulated by the voice frequencies. A voice tone of 400 cycles per second, for example, causes 400 variations in the amplitude of the carrier wave per second. A weak voice tone applied to the mike causes a small variation in the amplitude of the carrier. A loud voice tone likewise causes a large variation in the amplitude of the carrier. These variations in the amplitude of the carrier wave are alternate increases and decreases in the carrier wave. A given increase in the carrier amplitude above the resting value must always be followed by an exactly similar decrease below the resting, or average value. The upper limit of modulation occurs when the voice tone causes the carrier amplitude alternately to double its resting value and then go to zero on the succeeding half cycle. Any increase in modulation beyond this point results in overmodulation of the carrier wave, which is undesirable because it causes unnecessary interference with other radio services.

Thus we come to the conclusion that there is a definite relationship between the resting, or normal, amplitude of the carrier wave, and the amplitude of the voice frequency waves which modulate that carrier. Thus any phone transmitter must be designed and built so that the amplitude of the voice waves bears a definite relationship to the carrier amplitude, for best modulation.

Receivers

In the receiver the process generally described above is reversed. The modulated carrier wave is selected from among the many thousands of carrier waves on the air by the process known as tuning.

A selective tuned circuit is simply a filter or gate through which signals of a desired car-

rier frequency may pass, though signals of any than the desired frequency are rejected. After the desired signal has been selected and amplified through various vacuum tube amplifiers it is *demodulated* by the process known as detection. This process separates the voice frequency waves from the carrier wave, eliminates the carrier wave and passes the voice frequency waves on to a voice frequency amplifier to be again amplified to a value great enough to actuate a loud speaker. That is all there is to it. In figure 1 is shown a block diagram of a complete radiophone circuit from microphone to loud speaker.

There are certain rules which must be observed in order to get good results from a radiotelephone transmitter which will be briefly outlined here.

The microphone and voice frequency amplifier must not change the voice frequencies in any way. Anything taken away or added to the voice frequency waves constitutes distortion. Frequency distortion occurs when the various complex voice tones are not amplified equally well and tones of certain frequencies become amplified more than others. This destroys the original relationship between the amplitude of the various tones and overtones constituting the original sound impressed on the mike.

The other common type of distortion is amplitude, or harmonic distortion. Harmonic distortion occurs when the output of the voice frequency amplifier contains voice frequency waves that are generated in the amplifier or microphone itself, and were not present in the original sound impressed on the mike. Harmonic distortion makes the reproduced voice sound "fuzzy" or harsh and makes the voice sound unnatural as well as reducing the intelligibility of the transmission.

There are other faults that can affect a phone transmitter. *Non-linear modulation* is a fault of the coupling circuit between the last voice frequency amplifier and the carrier frequency amplifier to which the modulation is applied. It can also result from improper adjustment of the modulated carrier frequency amplifier. The result of non-linear modulation is harmonic distortion.

There are other faults that can affect a phone transmitter. *Non-linear modulation* is a fault of the coupling circuit between the last voice frequency amplifier and the carrier frequency amplifier to which the modulation is applied. It can also result from improper adjustment of

the modulated carrier frequency amplifier. The result of non-linear modulation is harmonic distortion.

Carrier shift is usually a fault of the modulated carrier frequency amplifier. If the *average* amplitude of the carrier output does not stay absolutely constant, the average amplitude shifts either up or down. Carrier shift causes unnecessary interference to other radio services due to what is known as sideband splatter. Carrier shift always accompanies overmodulation of the carrier. Carrier shift is also known as unsymmetrical modulation.

Overmodulation occurs when the amplitude of the voice frequency modulating wave is too great for the carrier. In other words, the carrier amplitude is being varied more than up to twice normal and down to zero.

Frequency modulation occurs when the frequency of the carrier is not held absolutely constant, but is affected by the modulation. This fault causes unnecessary interference and is remedied by improving the isolation between the carrier frequency oscillator and the carrier frequency amplifier to which the voice modulation is applied.

Excessive carrier noise. This fault is usually traced to excessive a.c. hum or ripple in the high voltage direct current power supplies used to feed the various vacuum tube amplifiers used in the transmitter. The result of excessive carrier noise is to mask the weak sounds applied to the microphone. As the upper limit of loudness is set by the point of 100% modulation of the carrier, the lower limit is set by the carrier noise. Thus excessive carrier noise cuts down the *volume range* of the phone transmitter. The remedy is to use additional hum filters in the various high voltage d.c. power supplies.

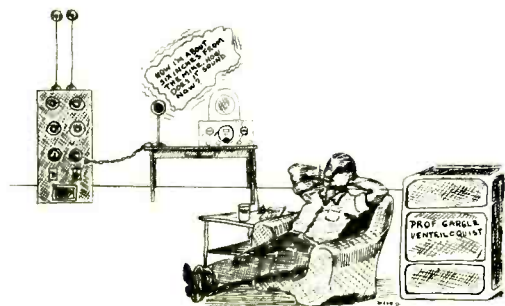

BETTER VOICE CODES

The constant need of using words in amateur radiotelephony to clarify call letters and other easily confused things, has forced phone amateurs to resort to hand-whittled devices such as

"This is W1FG — one, Florida, Georgia."

This is pretty bad, because it names two states in which the station might be, whereas it is actually in Connecticut. Of course, if there is no QRM, that's another story. But the amateur bands are not such a Utopia yet.

How about junking state names for such purposes, and using some sort of non-misleading words? Just for a starter, here is a code which has been in more or less common use in landline telegraph offices:

ADAM	JOHN	SUGAR
BYRON	KING	TOM OR
CHARLES	LINCOLN	THOMAS
DAVID	MARY	UNION
EDWARD	NORMAN	VICTOR
FRANK	OCEAN	WILLIAM
GEORGE	PETER	X-RAY
HENRY	QUEEN	YALE
IDA	ROBERT	ZERO

As there is nothing official about such a code, there naturally arise some variations. A few of the most common are:

BOSTON	DENVER	YOUNG
CHICAGO	NEW YORK	

Names of cities, however, would appear to be likely to cause confusion just as with those of states.

And if you don't like that code, here's another one that has been in occasional use since the earliest phone days:

ABLE	JIG	SAIL
BOY	KING	TARE
CAST	LOVE	UNIT
DOG	MIKE	VICE
EASY	NAN	WATCH
FOX	OBOE	X-RAY
GEORGE	PUP	YOKE
HAVE	QUACK	ZED
ITEM	ROT OR RUSH	

VT, ND, GA, and DC are the only radio abbreviations on the map of the U.S.

Most of the W6 calls starting with the letter N are assigned to Navy men.

The 1st Call Area is the only one in the Country embracing an entire geographical section of the U.S. with no "sidebands" in other sections. The 1st is entirely New England.



Resonant Harmonics for Various Wire Lengths

Length	$\frac{\lambda}{2}$	λ	2λ	4λ	8λ
133' 7"	3,500	7,185	14,550	29,210	58,760
129' 10"	3,600	7,390	14,970	30,130	60,450
126' 4"	3,700	7,595	15,390	31,010	62,135
123'	3,800	7,800	15,820	31,800	63,800
119' 10"	3,900	8,005	16,300	32,640	65,500
118' 4"	3,950	8,110	16,420	33,060	66,330
116' 10"	4,000	8,210	16,620	33,450	67,140
66' 9"	7,000	14,370	29,105	58,730	
66' 4"	7,050	14,470	29,305	58,990	
65' 10"	7,100	14,570	29,510	59,290	
65' 4"	7,150	14,670	29,710	59,800	
64' 11"	7,200	14,775	29,940	60,260	
64' 6"	7,250	14,880	30,130	60,640	
64'	7,300	14,985	30,365	61,110	
33' 5"	14,000	28,720	58,180		
33' 2"	14,100	28,950	58,640		
32' 11"	14,200	29,160	59,090		
32' 9"	14,300	29,290	59,340		
32' 6"	14,400	29,550	59,870		
16' 8½"	28,000	57,440			
16' 5"	28,500	58,500			
16' 1½"	29,000	59,595			
15' 10½"	29,500	60,710			
15' 7½"	30,000	61,500			
8' 4"	56,000				
8' 2¾"	57,000				
8' ½"	58,000				
7' 10¾"	59,000				
7' 9"	60,000				

Radiation Resistance of Harmonic Antennas

No. of $\frac{\lambda}{2}$	Radiation resistance ohms	Angle of maximum radiation	Power in major lobe of radiation
1	72	90°	1
2	90	55°	1.15
3	100	46.5°	1.25
4	110	37°	1.35
5	115	34.5°	1.5
6	122	30.5°	1.7
7	125	28°	1.85
8	131	27°	2.1
9	135	25.5°	2.3
10	139	24°	2.55
11	142	22.5°	2.75
12	145	21°	3.1
13	148	20.5°	3.3
14	150	20°	3.65
15	152	19.5°	3.9
16	154	19°	4.25
17	156	18.5°	4.55
18	158	18°	4.9
19	160	17.5°	5.25
20	162	17°	5.65
21	163.5	16.5°	6.0
22	165	16°	6.3
23	166.5	15.5°	6.75
24	168	15°	7.2

The radiating portion of an antenna does not resonate on integral harmonics of its fundamental frequency. This point is not generally appreciated. It is a common assumption that a half-wave antenna cut, for example, for 3500 kc. (133'7") resonates on all the integral harmonics of 3500 kc. and thus can be used on 7000, 14,000, 28,000 and 56,000 kc. Actually, a half wave antenna cut for 3500 kc. resonates at 7185, 14,550, 29,210 and 58,760 kc. These frequencies are related by the formula

$$F = \frac{(K-.05) 492,000}{L}$$

where F is the frequency in kilocycles, K is the number of half waves on the antenna, and L is the length of the antenna in feet.



Dimensions for Matched Impedance J, T, Q, Single-Wire-Fed, and Collins Antennas

Frequency in Kilocycles	Quarter wave feeder section	Half wave Radiator	Dis. from end of radi- ator to feeder tap
	$\frac{234}{F_{mc}} = \frac{.95\lambda}{4} = N$	$\frac{467.4}{F_{mc}} = \frac{.95\lambda}{2} = L$	$D = \frac{169.2}{F_{mc}}$ (single wire feed)
3500	66' 10"	133' 7"	48' 4"
3600	64' 11"	129' 10"	46' 8"
3700	63' 2"	126' 4"	45' 7"
3800	61' 6"	123'	44' 6"
3900	59' 11"	119' 10"	43' 3"
3950	59' 2"	118' 4"	42' 8"
4000	58' 5"	116' 10"	42' 1"
7000	33' 5"	66' 9"	24' 2"
7050	33' 2"	66' 4"	23' 11"
7100	32' 11"	65' 10"	23' 9"
7150	32' 9"	65' 4"	23' 7"
7200	32' 6"	64' 11"	23' 4"
7250	32' 3"	64' 6"	23' 3"
7300	32'	64'	23' 2"
14,000	16' 9"	33' 5"	12' 1"
14,100	16' 7"	33' 2"	12'
14,200	16' 5"	32' 11"	11' 10.5"
14,300	16' 4"	32' 9"	11' 9"
14,400	16' 3"	32' 6"	11' 8"
28,000	100"	16' 8.5"	72"
28,500	98.4"	16' 5"	71"
29,000	96.5"	16' 1.5"	70"
29,500	94.8"	15' 10.5"	69"
30,000	93"	15' 7.5"	68"
56,000	50"	100"	36"
57,000	49.2"	98.4"	35.5"
58,000	48.3"	96.5"	35"
59,000	47.4"	94.8"	34.5"
60,000	46.5"	93"	34"

Quick-reference guide for determining radiator and feeder (matching section) length for the J, T, Q, and Multiband antennas: Also for determining the proper point at which to attach a single-wire feeder for optimum results for one-band operation. For operation on more than one band, the flat top should be cut for the highest frequency band and the single-wire feeder tapped one-third of the way in from one end, disregarding the figures given in the right-hand column of the above chart. The antenna will then work equally well on several bands with but a slight reduction in efficiency.

Pentodes and Tetrodes in Ham Transmitters

By R. M. PURINTON, W2ICU

Pentodes and tetrodes are now almost as common in amateur use as triode transmitting tubes. The development and use of these screen-grid tubes has progressed at a surprising rate considering the fact that no important improvement in triode tube design was made over a period of almost twenty years. The first transmitting pentode, designed particularly for the amateur, in this country was the RK-20 which was introduced about two and a half years ago. Prior to this, pentodes had been put to experimental use in England where all of the advantages of the pentode tube, including suppressor-grid modulation had been noted. Of course, we have had tetrodes such as the 865 for a long time, but these tubes were expensive and did not provide the possibility of high-quality modulation with one of the grids, using low audio power.

Tube Comparisons

A comparison may be made between triodes and pentodes as radio-frequency amplifiers against these same tubes used as Class A audio

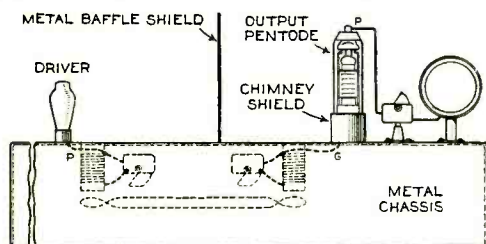

Figure 1
Proper method of shielding a
pentode amplifier.

amplifiers. In an audio amplifier the triode or pentode is called upon to act either as a producer of power output or as a voltage amplifier. In the amateur transmitter where these tubes are used as buffer or final stage amplifiers, they are called upon to deliver power all of the time, and while we may speak of a stage as producing voltage amplification principally, the triode or pentode is operating more nearly as a power amplifier than as a voltage amplifier. This difference exists simply because of the fact that in the Class A amplifier the grid of any driven tube does not draw current, or in other words become positive, and in the r.f. amplifier the

grid of each tube in the system draws current if the tube is operating Class C.

The grid impedance of any amplifier tube varies from a comparatively high value (100,000 ohms or more) if the grid never becomes positive, to an average value of only a few thousand ohms if the grid is permitted to become positive for a part of each half cycle. The grid circuit of a driven tube is directly parallel with the plate circuit of the driven tube. Therefore, if the grid remains negative at all times and has a high impedance, the driven tube will operate satisfactorily if it has a high plate impedance and the tube can operate with a high resistance plate load capable of delivering considerable voltage.

On the other hand, if the grid is driven positive as in Class C, some grid current will flow and power will be dissipated in proportion to the amount of grid current and the voltage which produces it. This condition calls for the delivery of power from the driver stage sufficient to equal the power dissipated in the grid circuit plus the losses in the coupling device. Good power drivers and similarly final power amplifiers have a reasonably low plate impedance which will match a low resistance load such as a following grid circuit which draws current during a part of the positive half cycle. As a power amplifier, a high impedance plate circuit tube such as a receiving type 57 is unsatisfactory. A tetrode such as the receiving type 6L6, in which the design provides low plate impedance, will work efficiently into a grid circuit which draws current.

Certain types such as the 865 and 6L6 and the more recent RK-39 are tetrodes having only the control and screen grids. The 6L6 operates as though it had a third or suppressor grid by virtue of the position of the control and screen grids with respect to each other. Tubes such as the 2A5, 41, 42, 47, 59, and 89, in the receiving lines, and RK-20, RK-25, and RK-28 are all pentodes with a third or suppressor grid. The purpose of the suppressor grid, in addition to permitting suppressor-grid modulation in types where the suppressor grid is brought out to a separate base pin, is to eliminate secondary emission. Without going into a study of secondary emission it is sufficient to say that secondary emission in an oscillator or amplifier circuit would have two effects: First, the pos-

sible production of spurious frequencies and second, instability.

Many of the receiving type pentodes can be used as radio-frequency oscillators and as driver tubes for larger pentodes. Types 2A5, 41, 42, 47, 59, 89, 6L6 and 6L6G are all suitable for

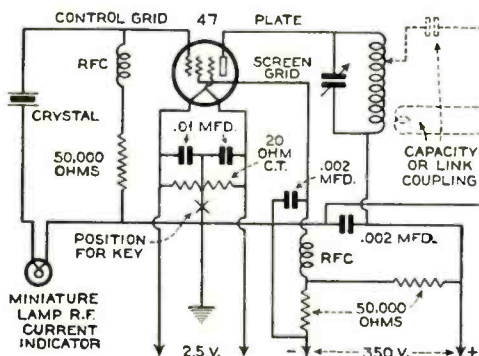

Figure 2
Circuit of crystal-controlled pentode oscillator.

this use and the two latter types will handle sufficient power to function as final amplifiers in a low-power transmitter. The RK-25 is useful also as an oscillator and r.f. amplifier.

Selecting the Tube

This listing brings up a question as to the relative merits of receiver type tubes as compared with a tube like the RK-25. In most receiver tubes and in fact all of the receiver types listed, the original design was based on audio power output usage. For this purpose the screen grid was made necessarily coarse in pitch. Such a screen does not provide a perfect capacity shield between the plate and control grid of the tube. Tubes such as the RK-25 and the similar RK-23 (2.5 volt heater) were designed for radio frequency rather than audio use and they have a screen grid which provides a really effective electrostatic shield between plate and control grid. For doubler use, oscillation trouble is not a factor and the tube with poor screening will operate satisfactorily. In buffer service where the tube functions as a straight radio-frequency amplifier with the input and output operating at the same frequency, the grid-plate capacity can cause trouble if it is of appreciable value. Under this condition, the receiving type pentode falls down and will not provide operation without oscillation unless neutralization is used. The choice of a tube for oscillator, doubler and buffer use will be dictated by the amount of power needed and by

the flexibility desired in the transmitter. If a tube must function at one time as a doubler and with transmission on another band as a direct amplifier, it is best to use a tube with good internal shielding made especially for the purpose.

Shielding

The matter of shielding is important in any transmitter and particularly in one using pentodes as direct amplifiers with no neutralization. In the transmitter using triodes, neutralization will counteract, to a certain extent, the coupling between input and output circuits other than the internal coupling which exists between the grid and plate of the triode. In an amplifier stage using a well shielded tube, however, it might be assumed that no precaution need be taken to prevent self oscillation. It is only necessary to examine a receiver to come to the conclusion that some degree of shielding is absolutely necessary if coupling between the input and output circuits is to be avoided.

Figure 1, is shown as an example of shielding which should be employed as a minimum if the driver tube operates on the same frequency present in the output circuit of the driven amplifier. The plate circuit of the driver, whether it be link coupled or capacity coupled to the driven stage, is a part of the

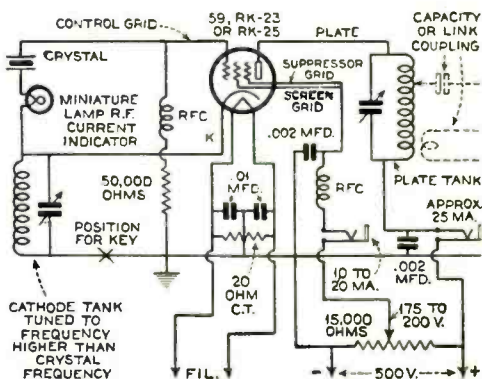

Figure 3
Crystal-controlled pentode oscillator in triode circuit.

grid circuit of the driven stage. If the plate coil of the driver is within the field surrounding the plate of the driven tube or the field surrounding the plate tank of the driven tube, some reaction is bound to be present and it is likely to be detrimental whether the coupling is such as to provide either regeneration or degeneration. The best policy is to shield the

driver tuned circuits from the tuned circuits used in the driven amplifier.

Bias for pentode and tetrode stages can be obtained by using any of the methods common to triode circuits. The cathode resistor method can be used but it is likely to cause some re-

power output will increase until a point is reached where the screen voltage is at or near the manufacturer's rating for the tube. Above this point it will be found that the power output no longer rises but begins to fall.

Excitation

The effect of excitation can be measured in two ways. The first is by the amount of screen current flowing, and the second by the amount of plate current which flows when the plate tank circuit is not tuned to resonance. Obviously the latter method should not be used because the normal high voltage on the plate will cause a harmfully large plate current to flow if excitation is normal. The screen current check is normal in every way and tells the full story. In any of the circuits shown, it will be noted that the screen grid of each tube is by-passed to ground or to cathode. The screen thus has no load circuit with impedance to radio frequency and the screen current will be proportional only to the screen voltage, the control-grid bias and the r.f. voltage applied to the control grid. It is easily possible to gauge excitation then by adjusting the drive to a pentode or tetrode to the point where with correct control-grid bias (-75 volts to -100 volts) the screen current is normal. It is generally true that the screen voltage and excitation should be adjusted for maximum output from the plate circuit. It may seem surprising that

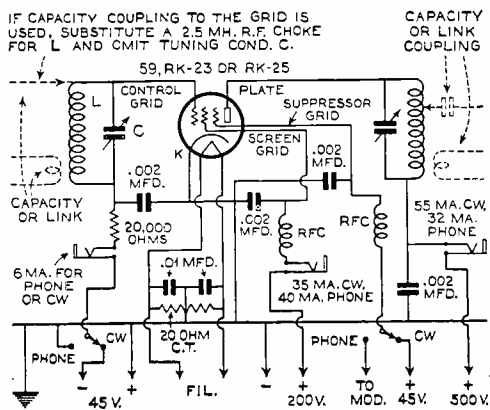

Figure 4
Final amplifier circuit using low-power pentode.

generation through coupling which develops in the cathode circuit between the control, screen and suppressor grids and the plate. If cathode bias is used, it is suggested that the cathode resistors be by-passed with mica condensers of $.01 \mu\text{fd}$. The most satisfactory method is through the use of a grid leak or a combination of grid leak and battery bias. Most pentodes and tetrodes, including the receiving types, are designed to operate best at a control-grid bias voltage of approximately minus 100 volts.

Screen Voltage

In replacing triodes with tetrodes or pentodes, it will be noted that there is only one fundamental change, which is the addition of the screen grid. The voltage applied to the screen grid should never be higher than the manufacturer's rating for two good reasons: First, excessive voltage causes excessive screen current which wastes power and robs the plate of electrons; second, excessive screen voltage and screen current overheats the screen grid and produces instability and loss of power.

An excellent method of controlling the output of a screen-grid tube consists of causing a variation in screen voltage by means of a heavy-duty volume control type of resistor or potentiometer. Using this type of control it will be found that as the screen voltage is raised, the

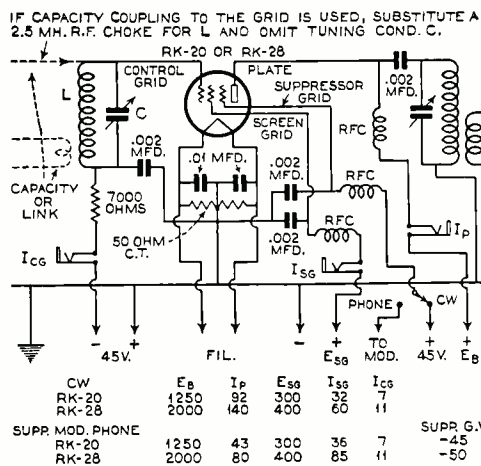

Figure 5
Final amplifier circuit using power pentode.

if either excitation or screen voltage is too great, the output power falls. These two factors are important and, along with shielding, they should be remembered.

It is reasonable to say that tetrodes and pentodes offer more flexibility and higher efficiency in the amateur transmitter than can be had using triodes. At the same time it must be said that the pentode or tetrode calls for more attention in making initial adjustments and in setting up proper operating voltages. If trouble is encountered with pentodes, the trouble is no more complex than in the case of triodes. The fundamentals are the same and the solution is no more complicated. An understanding of the fundamentals as we have tried to set them

descent when the current is .150 ampere. It is a simple matter to calibrate it for lower values of current with one of the station meters, a rheostat and 6.3 volts of d.c. from the station battery or the battery line in an automobile.

Figure 3 shows the conventional triode oscillator, which is widely used with transmitters operating on several bands. This oscillator is a strong producer of harmonics. Type 59 tubes, if selected for r.f. use, are good oscillators but a special tube made for r.f. use is preferred. It will be noted that the crystal-current indicating lamp is shown with this circuit also. The lamp is a great aid in adjusting the excitation control (cathode tuned circuit) to a frequency where the crystal will receive the proper amount of excitation and no more. One position for a key is indicated by the mark X. Breaking the cathode circuit at this point provides clean-cut chirpless keying and does not endanger the heater-cathode insulation because the cathode voltage with the key up is less than 100 volts. Normal current values are shown for the tube in oscillation.

Figures 4, 5, 6 and 7 show pentode amplifiers in single-ended and push-pull circuits using low, medium and high-power tubes. As in Figure 3, the approximate normal currents for the screen and plate circuits are shown. Grid bias is shown derived from grid-leak resistance alone for phone operation and from a combination of a grid leak and battery for c.w. This latter method calls for only 45 volts of negative battery bias which is sufficient to cut off the plate and screen current while the key is up. Failure to secure complete cut-off can be traced usually to poor regulation of the screen voltage; that is, to a large increase in screen voltage over the normal with the key up.

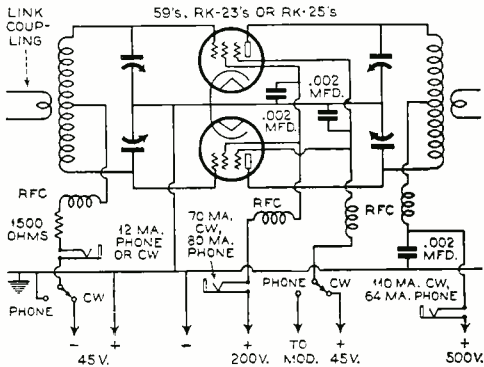

Figure 6
Double ended final amplifier using low-power pentodes.

down will enable the amateur operator to get the most out of his transmitter.

Circuits

Figures 2 through 7 show typical pentode operating circuits. While these are familiar to most amateurs, either through the reading of RADIO and other amateur publications or through actual use, some comment on each may be worth while.

A typical straight pentode crystal oscillator is shown in Figure 2. While the tube shown is a 47, the circuit performs well with any of the other receiving pentodes. The 47 has some advantage as a filament type tube over heater-cathode types because the input capacity is somewhat lower. This advantage may be useful in higher frequency circuits made possible by the introduction of crystals cut for oscillation at frequencies as high as 14 m.c. The addition of a miniature lamp as a crystal-current indicator is worth while and useful in adjusting the circuit voltages to provide maximum output without damaging the crystal. The lamp which is recommended is the Mazda 6.3 volt, 150-milliamperere dial light. It is identified by a brown glass bead holding the tiny support wires which carry the filament. The lamp is incan-

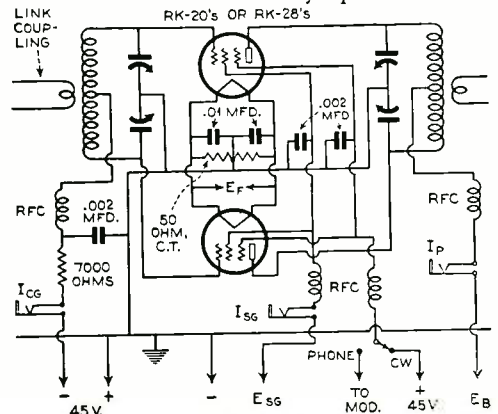

Figure 7
Double ended final amplifier using power pentodes. (See Figure 5 for Icg, Isg and Ip values.)



How Loud Is Sound?*

In order to answer this question it is necessary to carefully define what is meant by sound. Usually sound is defined as the sensation produced upon the ear by the vibration of air particles, although vibrating solids applied to other parts of the body may also produce the sensation of sound. With this definition as a basis it is at once obvious that the loudness of a given sound will vary with the individual and that we are primarily concerned with the objective characteristics of the air particle vibrations such as frequency, amplitude velocity, etc., only as they are effective in inducing an auditory response.

A difficulty is that a given vibratory condition induces a different response in different individuals. This difficulty can be to some extent overcome by testing many different persons and determining the characteristics of the average or normal individual and relating them to the objective characteristics of air particle vibrations.

Although the law of auditory response to a stimulus of constant frequency is approximately logarithmic, there are substantial departures especially at the higher sound levels. Furthermore, as is well known, the intensity of a sound which can be detected by a given individual varies markedly with the frequency, the greatest sensitivity of the human ear being in the neighborhood of 1000 cycles per second. Indeed, few persons can detect a pure tone having a frequency below 30 cycles per second and the range of hearing rarely extends as high as nine octaves above this. The effect of the surrounding noise level, the condition of the listener and other factors, also affect the apparent loudness of sounds so that any system based entirely upon the physiological effect becomes so complicated as to be impractical.

It is possible, however, to express the characteristics of the vibratory motion of air particles in such units that their numerical value will approximate the resulting sensation of loudness closely enough to be useful and, moreover, be simple enough in their derivation to be readily usable. Such units should be proportional to the logarithms of the numerical values of the corresponding characteristics since this is the simplest function approximating the relationship between sensation and stimulus.

The American Standards Association has pro-

posed the use of 1×10^{-10} microwatts per sq. cm. as the unit of sound intensity. At 1000 cycles per second this is close to the average threshold of hearing, being a trifle below if anything, although perceptible to many people under good conditions of hearing. Intensity is a characteristic of sound waves which can be measured without great difficulty and is related to most other characteristics of sound waves such as pressure, velocity, amplitude, etc., by simple equations.

Since the decibel scale is essentially logarithmic, if the sound intensities are expressed in decibels referred to the preceding proposed standard as a base, the results correspond sufficiently well to the auditory sensations produced to be practically useful. The effect of frequencies outside the audible range can be overcome by limiting the frequency range of response of the measuring apparatus.

Since the unit "microwatt per sq. cm." has the dimensions of power, any values may be converted into decibels. Values of microwatts per sq. cm. corresponding to various decibel levels are given in the fifth column of the table printed on the opposite page.

In the design of acoustical apparatus or in undertaking the measurement of sound intensities it is often desirable to know the difference of pressure in the medium caused by the sound waves, or even the actual length of the excursion or travel of a vibrational particle of the medium. Here again there is a definite relation, and the values corresponding to various decibel levels are given in the second column of the table.

Similarly the relationship between decibels and particle velocity is apparent, and corresponding values are given in the third column of the table. These values are r.m.s. values and if maximum values are desired the figures should be multiplied by 1.414.

The actual amount of movement (excursion) of the air particles may be obtained by multiplying the average particle velocity by the time. The particle excursion for a frequency of 1000 cycles is given in the fourth column of the table.

In order to aid in forming a mental picture of the values involved and to assist in relating them to various familiar sounds, some sound effects are listed in the first column of the table opposite the corresponding characteristics and decibel values.

* From an article by C. H. Tower, The Brush Development Company.



ACOUSTICAL LEVELS

Various Noises and Orchestral Effects	Sound Pressure	Particle Velocity	Movement of Air	Sound Intensities	Power Level
	Dynes per Sq. Cm.	Cm. per Sec.	Millimeters at 1,000 Cycles	Microwatts per Sq. Cm.	Deci- bels
Threshold	0.000204	0.0000050	2.22×10^{-8}	10^{-16}	0
	0.000363	0.0000089	3.95×10^{-8}	3.165×10^{-14}	5
	0.000645	0.0000158	7.00×10^{-8}	10^{-9}	10
	0.001146	0.0000281	1.25×10^{-7}	3.165×10^{-9}	15
Whisper 4' from source	0.00204	0.000050	2.22×10^{-7}	10^{-8}	20
	0.00363	0.000089	3.95×10^{-7}	3.165×10^{-8}	25
Soft Violin 12' from source	0.00645	0.000158	7.00×10^{-7}	10^{-7}	30
	0.01146	0.000281	1.25×10^{-6}	3.165×10^{-7}	35
	0.0204	0.0005	2.22×10^{-6}	10^{-6}	40
	0.036	0.00089	3.95×10^{-6}	3.165×10^{-6}	45
Bell F4 160' from source	0.0645	0.00158	7.00×10^{-6}	10^{-5}	50
Ordinary Conversation 3' from source	0.1146	0.00281	1.25×10^{-5}	3.165×10^{-5}	55
	0.204	0.0050	2.22×10^{-5}	10^{-4}	60
	0.363	0.0089	3.95×10^{-5}	3.165×10^{-4}	65
Bell F2 160' from source	0.645	0.0158	7.00×10^{-5}	10^{-3}	70
	1.146	0.281	1.25×10^{-4}	3.165×10^{-3}	75
Full Orchestra					
Bell F4 6' from source	2.04	0.15	2.22×10^{-4}	10^{-2}	80
	3.63	0.089	3.95×10^{-4}	3.165×10^{-2}	85
	6.45	0.158	7.00×10^{-4}	10^{-1}	90
	11.46	0.281	1.25×10^{-3}	0.3165	95
	20.4	0.5	2.22×10^{-3}	1.0	100
Bell F2 6' from source	36.3	0.89	3.95×10^{-3}	3.165	105
Thunder	64.5	1.58	7.00×10^{-3}	10.0	110
Hammer 2' from source	114.6	2.81	1.25×10^{-2}	31.65	115
	204	5.0	2.22×10^{-2}	100.00	120
	363	8.9	3.95×10^{-2}	316.5	125
Threshold of pain	645	15.8	7.00×10^{-2}	1000.0	130



Low-Cost C-R 'Scope for the Phone Man

The introduction of a cathode-ray tube with a list price in the vicinity of six dollars is somewhat of an event—but when the self-same tube is no larger than a 6L6, operates on an anode voltage as low as 250, and will perform all the tricks its older brothers are capable of, then its introduction is more than an event; it's a riot.

The tube we refer to is the new RCA Radiotron Type 913 midjet cathode-ray tube of the high-vacuum, low-voltage electrostatic type. It is shown in Figure 1. This tube has a fluorescent viewing screen approximately an inch in diameter and all the essential elements of the larger tubes. It is of all-metal construction with the result that the elements are *shielded* from external fields ordinarily capable of distorting screen patterns. The electron beam produces a brilliant, luminous spot having a greenish hue that produces a surprisingly clear pattern when deflected. The clearness and brilliance of patterns is due in part to the short sweep area of the fluorescent screen and the shorter electron path.

The tentative characteristics of this tube follow:

Heater Voltage (a.c. or d.c.)	6.3 Volts
Heater Current	0.6 Amp.
Direct Interelectrode Capacities:	
Control Grid to All Other Electrodes	10.5 max. μ fd.
Deflecting Plate D ₁ to D ₂	3.6 max. μ fd.
Deflecting Plate D ₃ to D ₄	4.3 max. μ fd.
Maximum Overall Length	4 3/4"
Maximum Diameter	1 3/8"
Base	Octal 8-Pin

Maximum ratings and typical operating conditions for the Type 913 are:

High-Voltage Electrode (Anode No. 2) Voltage	500 max. Volts
Focusing Electrode (Anode No. 1) Voltage	125 max. Volts
Control Electrode (Grid) Voltage	Never Positive
Grid Voltage for Current Cut-off*	—90 approx. Volts
Peak Voltage Between Anode No. 2 and any Deflecting Plate	250 max. Volts
Fluorescent-Screen Input Power Per Sq. Cm.	5 max. Milliwatts

Typical Operation:

Heater Voltage	6.3	6.3	Volts
Anode No. 2 Voltage	250	500	Volts
Anode No. 1 Voltage**	50	100	Volts
Grid Voltage	Adjusted to give suitable luminous spot		

Deflection Sensitivity:

Plates D ₁ and D ₂	0.15	0.07 Mm/Volt D.C.
Plates D ₃ and D ₄	0.21	0.10 Mm/Volt D.C.

*With approximately 100 volts (to focus) on Anode No. 1.

**Approximate.

The base pins of the Type 913 fit the universal 8-prong octal socket, which may be installed to hold the tube in any position. The base-pin connections of the tube are shown in Figure 2. Average characteristic curves are shown in Figure 3.

The 913 is applicable to any of the common circuits employed in conjunction with the larger cathode-ray tubes, such as the Type 906. It may



Figure 1
The type 913 midjet cathode-ray tube.

be used with or without horizontal and vertical amplifiers and need not use an internal sweep circuit if some other means of keeping the spot in constant motion is available. Moreover, the Type 913 is in no way limited in its applications and can as readily be used for the study of wave shapes, measurement of modulation and peak voltages, adjustment and location of faults in transmitters and receivers, etc., as the larger tubes. Since the viewing screen is small, it cannot be used at any great distance from the operator unless a magnifying lense is employed.

Installation

There are, however, a few points regarding its installation that are important. The metal shell is connected to Anode No. 2 within the tube, and in circuits where it is desired to operate the shell at a positive potential with respect to chassis ground, the shell should be entirely encased in a cylindrical tube of good insulating material. Bakelite or fibre tubing is suitable for this purpose. The front rim of the metal shell should also be *made inaccessible*

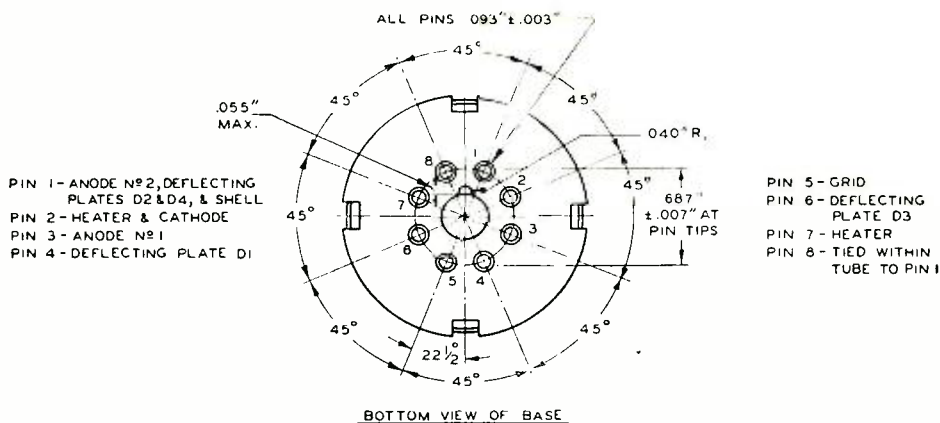

Figure 2. Pin connections for the type 913 cathode-ray tube. The shell connects to pin 1.

by means of a clear celluloid or glass plate mounted in front of the viewing screen. Where a separate d.c. power supply is used for the electrode voltages it is recommended that the shell be grounded, rather than the cathode terminal. With this method, which places the cathode and heater at a high negative potential with respect to ground, the shell need not be insulated from the chassis and the high voltage can more easily be made inaccessible. If the shell can not be connected to the chassis, as is the case where the Anode No. 2 voltage is obtained from the power supply of a receiver or amplifier, d.c. blocking condensers must be inserted in the signal input leads to both sets of deflecting plates, so that the anode voltage supply cannot be shorted by the signal circuit. These blocking condensers are designated as C_2 , C_3 and C_4 in the essential circuit for the Type 913 tube, shown in Figure 4.

Circuit Pointers

In order to maintain deflecting plates D_1 and D_3 at essentially the d.c. potential of Anode No. 2, each of these plates should be connected through a resistor of one to ten megohms to the Anode No. 2 socket terminal, as shown in Figure 4. This arrangement permits a choice of resistor value such that the electron beam is not distorted by d.c. potentials built up on the deflecting plates. If, during operation, the zero axis should be permanently deflected, it is usually because the beam current is too high for the resistors used. The beam current should ordinarily be kept low. In cases where the fluorescent spot is off center, a variable d.c. bias voltage of the necessary polarity should be con-

nected in series with one or both of the deflecting plate-resistors (at points marked "X" in the circuit of Figure 4). The polarity of each control voltage should be such that the spot can be shifted in the desired direction, or preferably, in both directions so as to provide a pattern-centering adjustment.

The high voltage in the filter circuit is dangerous, and care should be taken in the design of the oscilloscope to prevent anyone from coming in contact with hot leads or parts. Moreover, do not touch any part of the circuit without first turning off the power-supply switch and *discharging the filter condenser* by shorting it to ground.

The values of the resistors in the bleeder circuit should preferably be such that the total bleeder current is 2 or 3 milliamperes. If the total bleeder resistance is of too high a value, the spot on the screen of the tube will persist for some seconds and in consequence is apt to damage the fluorescent coating. A great deal is dependent upon the amount of capacity in the filter circuit, and if the spot persists after the power has been turned off, the spot should be kept moving by means of a sweep circuit controlled by a separate power switch. Since it is necessary for the same reason to maintain the spot in constant motion at all times during the operation of the oscilloscope, the use of a simple sweep circuit will take care of both problems. Of course, the spot can be removed from the screen before the power is turned off by turning the spot intensity and focusing controls to their minimum positions. The objection to this method is that one may forget.

Focusing of the fluorescent spot is controlled by adjustment of the ratio of Anode No. 2 volt-

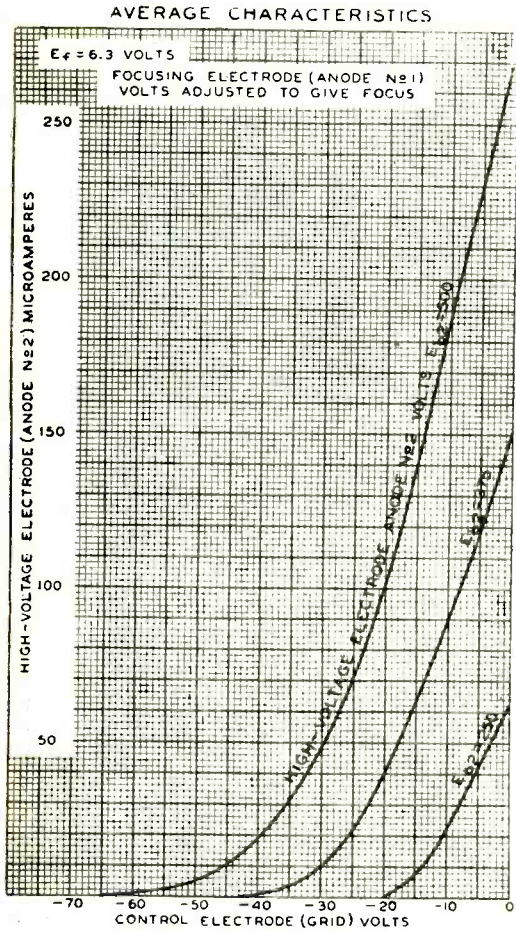

Figure 3

age to Anode No. 1 voltage. Ordinarily, the ratio is varied by adjustment of Anode No. 1 voltage, as shown in Figure 4.

Regulation of spot size and intensity can be accomplished by varying Anode No. 2 current and/or voltage. The current to Anode No. 2 may be increased by decreasing the bias voltage applied to the control electrode (grid). An increase in Anode No. 2 current increases the size and intensity of the spot. An increase in the voltage applied to Anode No. 2 increases the speed of electrons which increases spot intensity and decreases spot size. When any of these adjustments are made, consideration should be given to the limiting voltage and power ratings of the 913 tube previously listed.

Oscilloscope Circuit

A suitable oscilloscope for checking transmitters and the outputs of receivers and amplifiers

can be built around the type 913 tube, using as the basis of the design the circuit of Figure 4. Though this circuit is not complete in itself, all that need be added is a small power transformer of the receiver type capable of supplying approximately 250 to 500 d.c. volts to the filter circuit and having separate heater supply windings for the 913 and a type 1-V half-wave rectifier. The complete unit can be built into a compact metal cabinet, or mounted on one of the transmitter rack panels.

A sweep circuit, using an 885 tube, a neon tube, or simply a small transformer supplying from 110 to 180 volts a.c., may be used if desired, but is not essential. Of the three sweep systems, the 60-cycle sweep, employing a simple transformer, is the cheapest and easiest to handle. The a.c. voltage of the transformer is applied to the "horizontal-axis" plates of the tube, and by this means a modulated-envelope pattern can be obtained.

For general testing, adjusting or monitoring of a transmitter, the "trapezoidal" pattern is more easily interpreted and will disclose as much as the modulated-envelope pattern. No sweep circuit is required, for in this case the time-sweep voltage is taken directly from the output of the modulator. The r.f. voltage is applied to the "vertical-axis" deflecting plates through the oscilloscope signal terminals by means of a twisted pair and pick-up coil of one or two turns coupled to the tank circuit.

TYPICAL OSCILLOGRAPH CIRCUIT

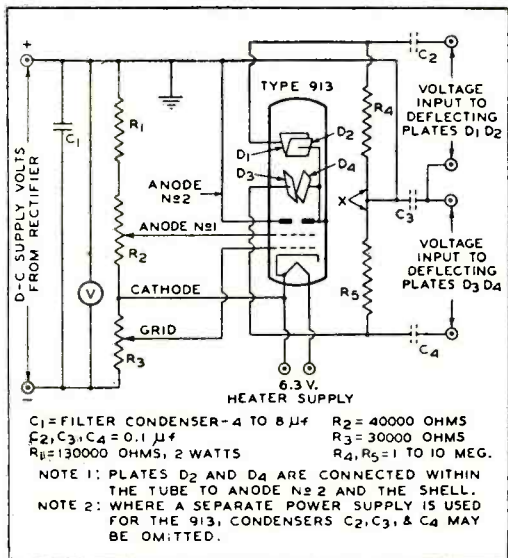

Figure 4

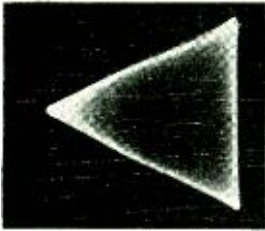

Figure 5

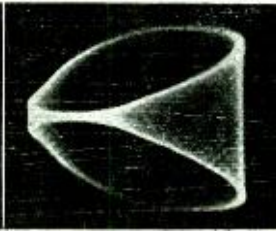

Figure 6



Figure 7

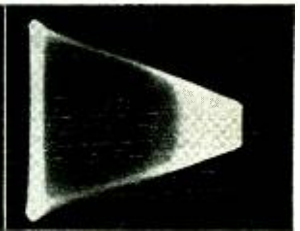

Figure 8

The r.f. voltage alone will produce a straight vertical line on the screen of the cathode-ray tube. The addition of an audio voltage from the output of the modulator, and fed to the "horizontal-axis" plates of the 913 tube through the "external sweep" terminals, will produce a pattern on the tube screen having the appearance of an isosceles triangle and having uniform shading on all three borders.

"Trapezoidal" Patterns

A photo of such a pattern is shown in Figure 5. This is the appearance of the pattern one should expect when all units of the transmitter are properly adjusted and the r.f. carrier is being modulated 100 percent. It should be noted that the pattern is close to being a perfect triangle, has uniform shading and straight lines. Any departure from this general appearance is an indication of improper adjustment or the presence of undesirable operating conditions. The proper interpretation of changes in the shape or shading of this basic pattern is all that is necessary for the purpose of disclosing any of the more common forms of transmitter ills.

The easiest way to become acquainted with the various shapes of pattern that are obtained under various conditions of transmitter adjustment and operation is to purposely carry out incorrect conditions of operation. Try as the first experiment the picking up of the audio voltage from some intermediate stage in the pre-amplifier rather than from the output of the modulator. Since the audio voltage at most

points other than the output of the modulator is out of phase with the audio envelope of the r.f. carrier, such an out-of-phase voltage applied to the time-sweep circuit of the cathode-ray tube results in a distorted pattern folded over on itself, as shown in Figure 6. The conditions of transmitter operation are still correct, and the pattern still retains somewhat the same aspect as the basic pattern shown in Figure 5, except for the addition of the "image." Should such a pattern develop under proper test conditions, it would indicate an out-of-phase condition, or might well be hum modulation.

Pattern Interpretations

If the r.f. carrier is overmodulated, the basic pattern will develop a "tail," as shown in Figure 7, the length of the tail depending upon the extent of overmodulation. On the other hand, if the carrier is undermodulated, the basic pattern assumes the shape of a trapezoid (the appearance of a fourth side parallel to one other side) as shown in Figure 8. The height of this fourth side with relation to the height of the side which it parallels is a measurement of the percentage of modulation. Thus, if we designate the dimensions of the left side of the trapezoid as H_1 and the dimensions of the right side as H_2 , the percentage of modulation can be calculated from the following equation:

$$\text{Modulation Percentage} = \frac{H_1 - H_2}{H_1 + H_2} \times 100$$

(Continued on Page 105)

Figure 9

Figure 10

Figure 11

Figure 12

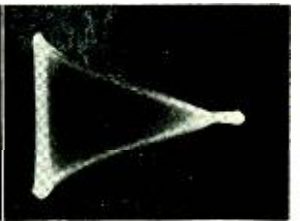
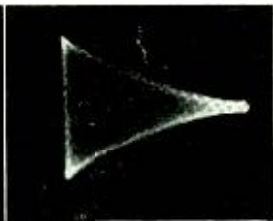
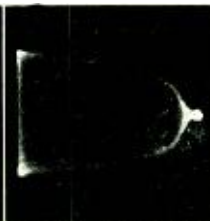
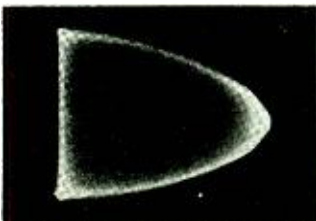

(The unretouched oscillograms appearing on this page were taken from the book, "The Cathode-Ray Tube Art Work," by John F. Rider.)



Power-Supply Circuits*

The 1936 model receivers employ power packs of varying complexities. Some of them are so involved that their function is often not readily understood from the usual schematic diagram. Others are so simple as to make their operation readily apparent. It seems desirable to examine the various types of power supplies, explain their functions and discuss their advantages and limitations. This is done below; all the circuits shown are employed in commercial receivers released during the past year.

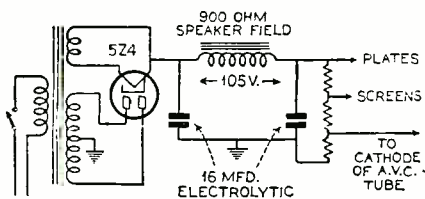

Figure 1
Power supply circuit for the smaller receiver.

The primary function of a power supply is to furnish the required a.c. and d.c. voltages to the tubes, properly filter the plate supply so as to avoid hum and have satisfactory regulation. All this has to be accomplished in the most economical manner and without causing the parts to overheat or to induce hum in the amplifiers or detector circuits. Usually the power supply also provides the necessary current for one or more speaker fields.

While discussing power supplies it is best to divide them into large groups. There are power supplies for a.c. only, others for d.c. only, some for a.c. and d.c., etc. In this article the d.c. supply will be omitted because few of them exist at the present time.

A.C. Power Supplies

The fewest parts which are employed in a practical power supply are a power transformer, a rectifier-tube and one filter section consisting of a choke and two electrolytic condensers. Generally the choke can be the speaker field, thus killing two birds with one stone. Figure 1 shows such a circuit which has become very popular for the smaller and even the medium sized receiver. The resistance of the choke must be correctly chosen so the total current

drawn by the receiver is just sufficient to produce the required excitation in the electromagnetic field of the speaker.

The circuit of Figure 1 is nearly the most economical one for small receivers. It is generally used with sets of relatively low sensitivity because there is only one filter section and any hum which reaches any of the early amplifying stages has only a limited amount of audio amplification. So, if this amplification is not too much the hum in the speaker can be kept at a negligible level. Some small receivers will also be found to employ some form of hum-bucking coil in the voice coil circuit.

Note that Figure 1 shows a voltage divider consisting of high-resistance units of the carbon type. The heavy bleeder of a few years ago is very little used nowadays. It is of course well known that in cases where a heavy bleeder is absent, the voltage of the B-supply will vary somewhat with the total current drain. The largest variation in drain is usually caused by the a.v.c. circuit which changes the bias on several tubes. In one case the plate voltage on the r.f. amplifier was 240 volts with a strong signal coming in but it dropped to 225 volts without a signal. The result may be a slight shifting in the oscillator frequency.

Another consequence of the lack of a voltage divider is a high-voltage surge when the receiver is turned on. There is no drain on the plate supply until the tubes have heated up, a

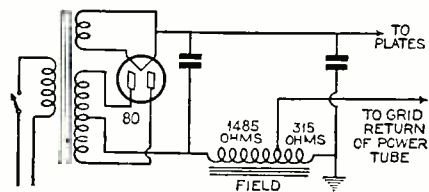

Figure 2
Method of obtaining C-bias from a tapped speaker field.

matter of 10 to 15 seconds, while the rectifier heats within two seconds. In such cases the voltage may go up to 500 volts temporarily, or even higher. The electrolytic condensers should then be chosen so as to withstand these surges. In the case of some rectifier tubes the surge does not occur because the rectifier heats as slowly as the rest of the tubes, so by the time the power supply delivers plate voltage, the tubes are ready to draw plate current.

* From an article appearing in The Aerovox "Research Worker."

Returning now to Figure 1, it is seen that there is a drop of 105 volts across the speaker field; consequently when making up the specifications for the power transformer, 105 volts must be added to the required plate voltage. It will occur to some that this is a waste and one would like to make use of this or at least a part of this wasted voltage. When the field coil is placed in the negative side of the filter, it becomes possible to utilize a part of the voltage drop as a C-bias supply. This is shown in Figure 2. A tap on the field coil has been so chosen as to provide the correct voltage drop for the grid bias of the power tube. Obviously, this bias supply needs additional filtering, but this is not hard to do because no current is drawn from the tap. Therefore a high resistance can be used in conjunction with a condenser as the filter unit.

Sometimes a field coil with the proper tap might not be available. In that case the same result can be obtained by connecting a tapped resistor across the choke or field as illustrated in Figure 3. The total resistance of this branch should be more than ten times the reactance of

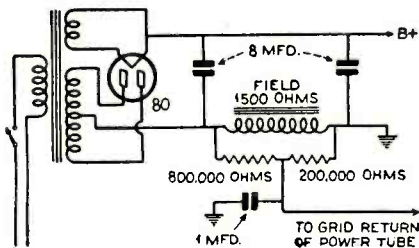

Figure 3
Obtaining C-bias by means of a tapped resistor shunting the speaker field.

the choke in order not to impair the filtering efficiency.

There is of course no objection to obtaining more than one C-bias voltage value from the parallel resistor. It is also possible to use a series resistance and tap it so as to provide one or more tubes with a negative bias; this is shown in Figure 4. Such a series-resistor should be *small* in comparison to the reactance of the choke.

A modified way of doing the same thing is shown in Figure 5. Here the choke is in the positive side and a tapped resistor is in the negative side to provide C-bias. Note that both bias supply lines have additional filtering.

The question will be raised as to whether there is any objection to the placement of the choke in the negative lead or in the positive lead. Theoretically it should be the same but

Prof. F. E. Terman and S. B. Pickles in the proceedings of the I.R.E. for August, 1934 point out the possibility that there may be some residual hum when the choke is in the negative side. This is due to the capacity between the secondary of the transformer and the electrostatic shield; no matter how much filtering is added, the residual hum cannot be removed, unless the positive side of the power supply is grounded.

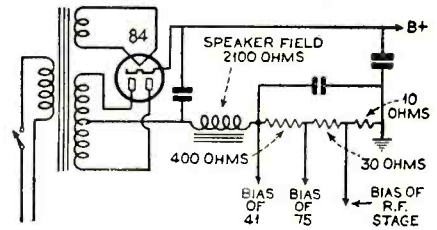

Figure 4
Obtaining C-bias by means of a tapped resistor in series with the speaker field.

The different forms of negative-leg filtering have now been exhausted and so we return to the filters with the choke in the positive leg. Figure 6 shows a circuit which takes care of C-bias supply by grounding a tap of the voltage divider. In some cases this is more desirable than providing each tube with a cathode resistor. The section of the voltage divider from chassis to B— carries all the current of all the tubes and consequently is less affected by the varying current in just one tube. A better stability of grid bias can then be obtained. However, this is by no means fixed bias such as required by certain class AB output stages. In order to have real fixed bias it is necessary to employ batteries or a separate power supply. These cases will be discussed later under "special power supplies".

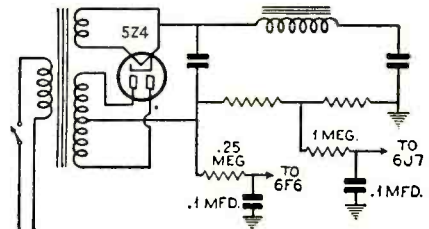

Figure 5
Here the speaker field is in the positive leg and the resistor in the negative leg.

Figure 7 illustrates a typical power supply for larger receivers employing two filter sections

and placing the speaker field in the second section. The filter stage ahead of the speaker greatly reduces the hum introduced by the field itself besides lowering the hum level of the plate supply. The voltage divider serves as a bleeder to deliver semi-fixed bias to the driver stage. The output stages however, as well as all other tubes are self-biased.

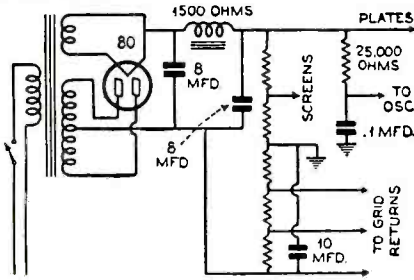

Figure 6
Method of obtaining C-bias by grounding a tap of the voltage divider.

Figure 8 shows a power supply for a really large set. The receiver in question employs three speakers. Two of the speaker fields serve as chokes for the filter while the first filter section contains a choke. This first section is tuned by means of the condenser across the choke. The combination is tuned to 120 cycles and being a parallel tuned circuit in series with the line it offers a high impedance to currents of its resonant frequency.

The 10,000 ohm field of the big low frequency speaker does not take part in filtering. It merely acts as a bleeder across the power supply.

A series of tubes is available which is suitable for this service because all heaters of the series require the same filament current (.3 ampere.) In general, all the tube filaments are placed in series and a resistor is added so as to provide the required voltage drop. This resistor is now generally placed in the power cord so as to remove the heat from the chassis.

When placing the filaments in series it makes quite a difference in which order they follow each other so as to produce the least hum. As one might expect, hum is introduced due to leakage between the cathode and the filament; this leakage will in turn depend on the potential difference between the filament and the cathode. Since all cathodes are connected to the negative side of the power supply, it follows that the most critical tube should be placed at the negative end. This is generally the detector. Starting from that side one encounters first the detector, then the r.f. and i.f. stages, then the a.f. stages and finally the rectifier.

The B-supply has only about 120 volts to start with, so it is not possible to employ high-resistance chokes. Consequently, the speaker field cannot serve as filter choke and it is generally connected across the B-supply. The maxi-

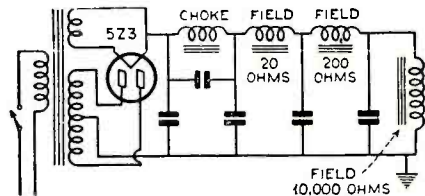

Figure 8
Typical circuit of power supply for a large receiver with high current drain.

A.C.-D.C. Circuits

A.c.-d.c. receivers offer some new problems. As far as the circuit is concerned, very little

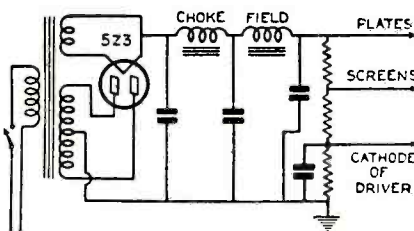

Figure 7
Typical circuit of power supply for larger receivers, using two filter sections.

variation is possible; Figure 9 shows a typical power supply of an up-to-date receiver. Let us take the problems one by one, beginning with the filaments because that seems easiest.

num rating of the 25Z5 rectifier is sufficient for the average receiver but sometimes two of them are used in parallel. Sometimes one encounters a design which utilizes one section of a 25Z5 for the field supply, the other section for the receiver proper.

Filtering a 60-cycle supply is twice as hard as removing a 120-cycle ripple. Reactances of chokes are only half as much as for 120 cycles and reactances of condensers are twice as high. So, in order to obtain the same filtering at 60 cycles as at 120 cycles one would need chokes of double the inductance and condensers of double the capacity. Fortunately, the small a.c.-d.c. set has a relatively low gain and the set has no transformers. Therefore there can be no inductive pickup from any power transformer although there is a choke. Resistance coupling



is usually employed which eliminates the dangers of hum pickup in audio transformers. One should not think, however, that the design of

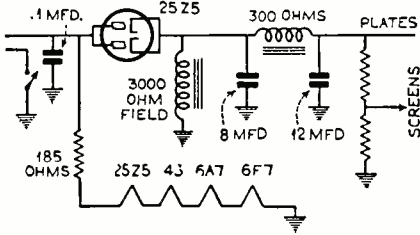

Figure 9
Typical power-supply circuit of an up-to-date receiver.

such a set is easy. Very careful placing of the parts is necessary if good results are to be obtained.

One filter section is usually all that is employed; large condensers are used and the choke can have larger inductance due to the relatively low current flowing through it.

Another problem with a.c.-d.c. sets is the fact that the chassis, if tied to the B— side becomes one side of the line and this may be the side which is not grounded. Accidental grounding of the chassis or the antenna wire would result in short circuits. The last danger is circumvented by placing a series condenser in the antenna lead and to make no provision for a ground connection.

There is still the possibility that the chassis may accidentally be touched by a grounded wire which may result in shorting the line. The only remedy seems to be to sever the connection

between the chassis and B— is employed to complete the circuit which is again likely to cause feedback and hum unless great care is taken.

Still another problem with a.c.-d.c. sets is their susceptibility to interference conducted along the line. The circuit of Figure 9 shows a condenser connected across the line in order to help remove this trouble.

A discussion of power supplies would not be complete without a consideration of modern automobile receivers. The systems in use at the present time include: motor-generators, dynamotors, synchronous and non-synchronous vibrators. The majority of automobile-receivers obtain their B power from the car battery by means of a vibrator system.

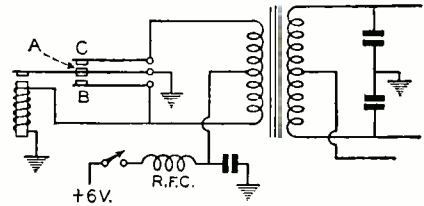

Figure 10
Circuit of non-synchronous vibrator-type power supply for auto-radio receivers.

Non-Synchronous Vibrators

The non-synchronous vibrator consists of an armature which is kept in vibration by an electromagnet on the same principle as the buzzer. At the same time the armature serves as a com-

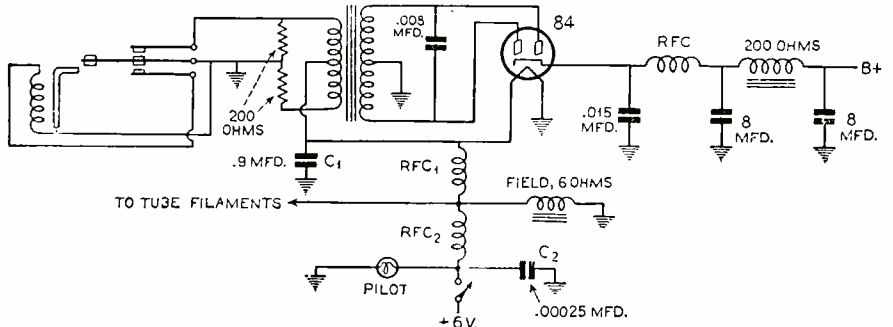

Figure 11
Non-synchronous vibrator-type power supply with necessary filter circuits.

mutating switch, continually reversing the primary current. The action is best illustrated by Figure 10. This diagram shows only the vibrator itself with the transformer and r.f. filter. When the switch is closed current will flow through the lower half of the transformer primary and

mutating switch, continually reversing the primary current. The action is best illustrated by Figure 10. This diagram shows only the vibrator itself with the transformer and r.f. filter. When the switch is closed current will flow through the lower half of the transformer primary and



then through the magnet windings. The armature is then attracted and contact A will touch contact B, thereby short-circuiting the electromagnet. The armature is then released again and swings back until contact A touches contact C. Meanwhile the electromagnet is attracting it again so that it keeps on vibrating at its own natural frequency and alternately touching contacts B and C. Now when contacts A and B are closed, the lower half of the primary is directly across the car battery, which will result in a heavy current from the center-tap downwards. When A touches C, the upper half of the primary is across the battery and a heavy current will flow from the center-tap upwards. These two impulses might be considered as alternating current although not of a perfect sine-wave form. An alternating voltage will be induced in the secondary which is rectified in the usual way by means of a full-wave rectifier tube. Type 84 was especially designed for this service; in the metal tube line the 6X5 serves the same purpose.

There are some special precautions to be taken in the design of vibrator systems. When the contacts A and B close there is such a sudden increase of current that a high voltage peak is induced in the secondary. The same is true when the other contacts close. Furthermore,

across the primary. The buffer condensers will absorb the sudden charges and thereby improve the waveform. Yet this alone is not sufficient to insure noise-free reception. The B-supply filter may contain an r.f. filter in addition to the regular a.f. filter and the filament circuit

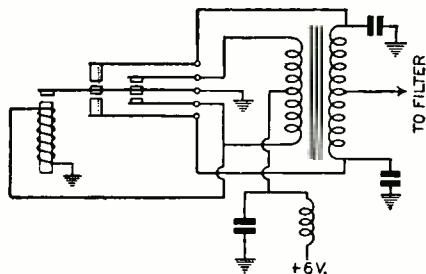

Figure 12
Circuit of synchronous vibrator-type power supply for auto-radio receivers.

may be filtered too. Also, the filament circuit should not have any part in common with the vibrator circuit—except the battery, of course. A typical circuit of an automobile power supply using a non-synchronous vibrator is shown in Figure 11. This circuit includes a center-tapped resistor across the primary and the usual buffer condenser across the secondary. Sometimes two condensers are connected across the secondary

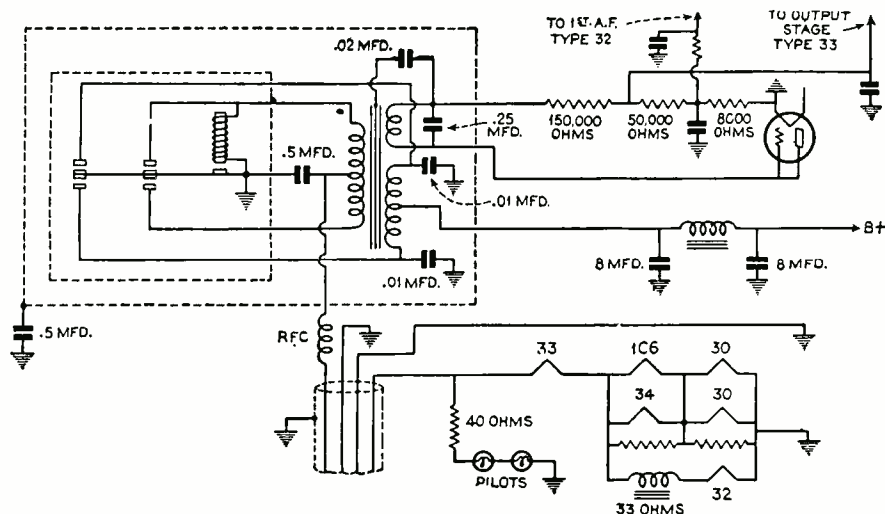

Figure 13
A modern power supply with synchronous vibrator and noise filters.

sparks are likely to appear at the contacts. Various ways have been devised to eliminate the interference caused by the vibrator. Buffer condensers are generally placed across the secondary and sometimes across the primary. Other manufacturers connect a center-tapped resistor

with the center-tap grounded. The values of these condensers might be in the neighborhood of .01 μ fd. They must have a high voltage rating.

Note the r.f. filter in the B-supply filter. There are also two filters in the filament sup-

ply. The first, consisting of RFC₁ and C₁, serves to eliminate the interference caused by the vibrator, while the other section, consisting of RFC₂ and C₂ is intended to eliminate ignition interference. In addition to all these precautions, both the vibrator and the power supply must be carefully shielded.

Synchronous Vibrators

The armature of a synchronous vibrator closes another set of contacts which serve to rectify the current in the secondary. Figure 12 shows the diagram illustrating the principle. When the armature moves downwards it not only closes the primary circuit but also the secondary; when it moves up, the other halves of both the primary and secondary are closed. Buffer condensers are again employed in the secondary to improve the waveform. The usual r.f. filters and a.f. filter are used as in the other vibrator systems.

A modern power supply with synchronous vibrator is shown in Figure 13. This receiver works from a 6-volt battery but employs 2-volt

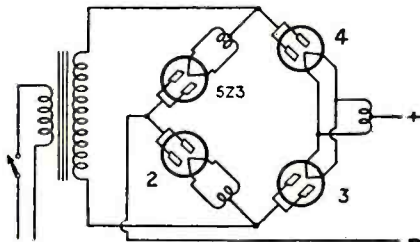

Figure 14
Circuit of bridge-type rectifier for securing high voltages from low-voltage tubes.

tubes. They are placed in series-parallel. Another peculiarity of Figure 13 is the separate C-supply. An extra winding on the transformer supplies an alternating voltage to a -30 tube connected as a diode rectifier. Two different bias-voltages are so obtained. The only filters in the C-supply are resistance-capacity filters.

Special Power Supplies

Some of the following schematics were not taken from any existing commercial receiver or amplifier, but they are included in the discussion because they are of interest to the amateur. Some other arrangements described below have been used in the larger radio receivers and p.a. amplifiers.

The first system that deserves our attention is the bridge-rectifier. Figure 14 shows a typical bridge-rectifier employing four type 5Z3 tubes. Of course, any similar rectifier tube could be employed, such as the 81, 82, 83, 80, etc. This system has certain advantages, especially for the

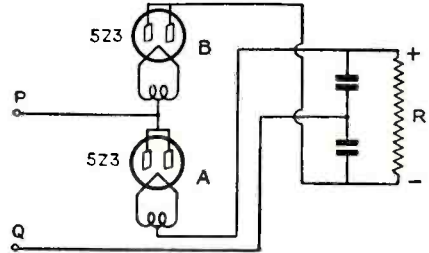

Figure 15
Circuit illustrating the operation of a bridge-type rectifier.

amateur who has limited equipment. When the rectifiers are connected as in Figure 14, either tube 1 and 3 or tube 2 and 4 are conducting. Two tubes are thus in series and the voltage supply can then be twice the maximum rating for one tube. Voltages of 1000 and over could be rectified with inexpensive high-vacuum rectifiers instead of using the high-voltage gas-filled types. However, a filament transformer with three different windings is required. Tube 3 and 4 can be supplied from the same 5-volt winding but the others must have separate windings. Transformers for this purpose are available from most of the transformer manufacturers.

Another advantage of the system is that the secondary does not need to be center-tapped.

The second special circuit to be discussed is the voltage doubler. A fundamental circuit is shown in Figure 15. Many people become confused when drawing or tracing a doubler circuit. Therefore we shall briefly explain the action. Rectifier A will conduct when point P becomes positive with respect to point Q. During this time the upper condenser will be charged up. During the next half cycle, rectifier B is conducting and the lower condenser is charged. These charges are such that they are in series and they can discharge only through the load R. In order to collect enough of a charge to keep the voltage up during discharge it is necessary to have large condensers. The voltage of the supply will drop considerably when too much current is drawn. This circuit can be used to obtain double the voltage from a transformer secondary or directly from the line. In the diagram of Figure 15 two different

rectifiers are shown which must have a transformer with two different windings to supply them. The 25Z5 and 25Y5 tubes have been made available for voltage-doubling service. They consist of two rectifier sections with insulated cathodes; so no transformer is necessary. A transformerless power supply, (which

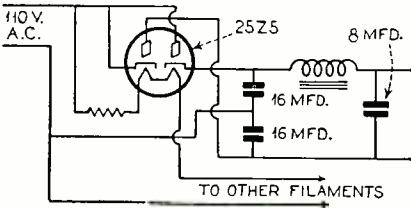

Figure 16
Circuit of transformerless power supply using the tube as a voltage doubler.

will work only on a.c.) is shown in Figure 16.

A 25Z5 is used as the rectifier; suitable output tubes for the purpose are the types 18 and 12A5. With these tubes it is possible to obtain a maximum output of 3 watts. This circuit would probably be more popular if it were not for the grounding difficulties. The chassis becomes 110 volts negative with respect to one side of the line. Accidental grounding of the chassis must be guarded against. A series condenser should be placed in the antenna lead and also in the ground lead if a ground is used. At the present time the use of voltage doublers directly from the line seems to be restricted to field supplies for dynamic speakers.

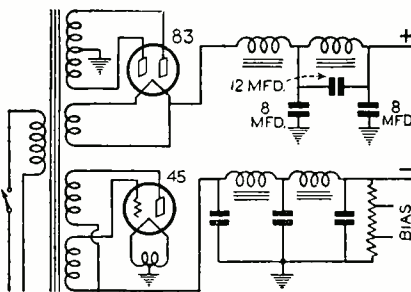

Figure 17
Power-supply circuit with separate bias supply rectifier and filter.

The amateur frequently employs voltage doubling to advantage. In his case a transformer would be employed which eliminates the grounding difficulties. Any part of the circuit can be grounded without danger. A transformer with a 700-volt secondary could deliver over 1400 volts, depending on the drain, with two rectifiers of the 5Z3 type. Two different fila-

ment windings are required and the maximum current is only half that of the same transformer delivering 700 volts.

Some of the larger receivers which utilize class AB output stages need grid-bias supply which does not fluctuate with the drain of the tubes. One way whereby this can be done is by means of a separate C-supply. To utilize this method the system has a transformer with an extra winding which is connected to a -45 tube rectifier. The circuit is shown in Figure 17; different windings deliver voltages to the grid and plate. These voltages are in phase and in the required proportion. Careful filtering is necessary because amplifiers of this type generally have considerable gain. Fortunately there is practically no drain on the grid-bias supply which makes it easier to filter.

Note that the filter for the plate supply has a tuned section and that choke input is employed.

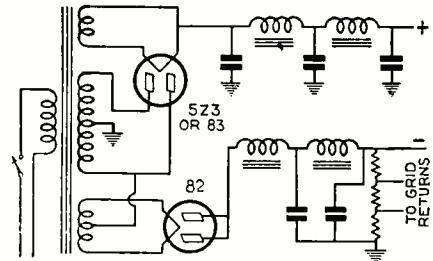

Figure 18
Another power-supply circuit with separate bias-supply rectifier and filter.

Figure 18 shows another way of obtaining an extra voltage supply for the grids. In this case the same transformer secondary serves a double purpose and this is indeed voltage doubling. An extra rectifier tube—which must have its own filament winding—is connected to one side of the secondary “in reverse,” i.e. with the filament tied to one of the high-voltage terminals and the plate to the input of the filter. This makes the extra tube conducting during the half cycle that the corresponding section of the other rectifier is not conducting.

Very little current need be drawn by the C-supply so that it need not unbalance the transformer drain too much. Some transformers have been made with an extra tap for grid-bias supplies. In that case, the filament winding of the extra rectifier connects to this tap. The rectifier employed is sometimes an 82 or a 45. A 2½-volt filament is preferred because it is easiest to find a transformer with an extra 2½-



volt winding. In general, any tube could be used which is directly heated. One must be sure to apply C-bias at the same time that plate voltage is applied or earlier. Some safety device should be employed so that the plate circuit will open if the bias supply should fail. A fuse in the plate circuit of the power tubes will generally be satisfactory.

Maximum Output

What is the maximum voltage and current obtainable from a given apparatus? If the question is put in this way, the answer is simple. There are several parts in your equipment, a power transformer, a rectifier tube, condensers and chokes. The power transformer delivers a fixed voltage to the rectifier. Curves of the rectifier's performance have been published by the tube manufacturers. These curves show the voltage to the input of the filter for a given transformer voltage and a given size of input condenser. The voltage varies with the current drawn by the load. So, if one knows how much the load will draw, the voltage delivered by the supply is equal to the voltage shown by the curves minus the drop in the filter.

There is another way to look at it. The transformer, the tube and the chokes all have their own maximum current rating. The lowest of these ratings is the maximum current rating of the power supply. The voltage is determined as in the above paragraph.

When one wishes to design a power supply to satisfy certain requirements the procedure is as follows. First determine the maximum total current drawn and the voltage required. Then a choice of circuits is to be made. When it is known how many filter sections are to be employed one can determine the type of choke and the voltage drops in them. The sum of the total voltage required by the load and the voltage drops in the chokes determines the required output of the rectifier. The manufacturer's curves again will indicate the required secondary voltage and the size of the input condenser. In general, a transformer with the exact voltage may not be available. The one with the nearest higher rating can be used. The excessive voltage can be taken up in chokes with higher resistance or a smaller input condenser can be selected which is a way to obtain the necessary voltage adjustment. Input capacities of less than $1\mu\text{fd.}$ will generally be required if the voltage is to be dropped appreciably.

Cathode Ray

[Continued from Page 97]

From this equation it is obvious that when H_c is zero, the modulation of the carrier is 100 percent.

When the operator has become acclimated to the variations in the height of the right side of the trapezoid, the percentage of modulation can be approximately determined without resorting to computation.

If the Class C stage is insufficiently excited, the basic pattern becomes non-linear, as shown in Figure 9. If, under these conditions, the carrier is overmodulated, the familiar "tail" appears, as shown in Figure 10. If the carrier were undermodulated, the nose of the pattern shown in Figure 9 would assume a blunt appearance.

Non-linear operating conditions are made evident by an inward curving of the sides of the basic pattern, as shown in Figure 11. This pattern also indicates excessive bias by the lighter shading of the nose.

The pattern of Figure 8 shows more than undermodulation as indicated by the blunt nose. The light areas are also an indication of audio distortion. It is apparent, then, that in an attempt to modulate the carrier 100 percent the speech amplifier or modulator has been overloaded. In other words, the speech equipment and/or modulator has not sufficient distortionless output to modulate the carrier 100 percent at the existing excitation level.

The opposite case is shown in the pattern of Figure 12. This indicates that the audio equipment is adequate to modulate the carrier 100 percent but has been pushed to the extent that both overloading and overmodulation take place, as evidenced by the tail on the pattern and the light areas.

Other shapes are assumed by the basic pattern under conditions of incorrect neutralization, improper tuning of the tank circuit, improper load conditions, the presence of hum and regeneration, etc. By introducing such conditions in the circuit of the transmitter the appearance of these patterns can be memorized for future reference.

If provisions are made to keep the oscilloscope in constant operation during all transmissions, any undesirable condition, such as overmodulation, will be immediately apparent and steps can be taken to correct the condition by the very convenient process of readjusting for the perfect triangular pattern shown in Figure 5.

Object: More DX—Method: Less Noise

By C. WATZEL, W2AIF, and W. BOHLEN, W2CPA

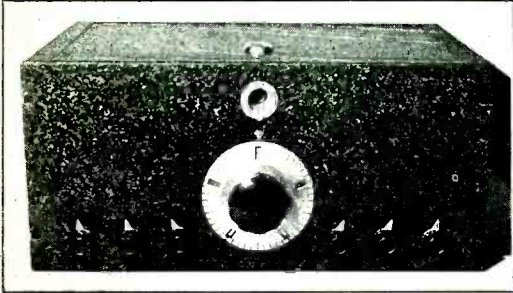

Panel view of high-gain receiver with "noise bucker", described in the accompanying article.

High receiver sensitivity is meaningless unless it is usable. The requirement is less noise in the receiver, so that the desired DX signals can be kept above whatever measure of noise is present in the receiver output. Noise resolves itself into two types; set noise, and noise produced external to the receiver. An attack is made at the problem of reducing both types of noise in the receiver to be described. Perhaps a bit of the background of this receiver will help explain the reasons for some of its design features.

The receiver is used at W2AIF. The station location is extremely bad in regard to auto QRM. The operating room is about 50 feet from a main traffic crossing, which has several bus lines passing through just to make the QRM problem more interesting. The chief interest of the station has been in working DX, and that mainly on 20 meters. Now that ten is so hot this band must also be added to the scheme of things. Since auto QRM and 10 and 20 meters are "that way" about each other, noise reduction has been a knotty problem.

The Fun Starts

The first crack at the noise situation came with the addition of a tuned 20-meter doubler to our old SW5. This did not reduce the noise any to speak of, but did reduce W2TP from an R9 plus—in the band or out of it—to an R3 peep. This gave us a chance to work someone besides Musty and Obie.

Jim Lamb's "Sniggle Sniggle Snooper" (in 1932) was the next noise-reducing effort. W2CPA built the 5-tube "hot dog" version of

this super, which used a regenerative i.f. stage. The "regenerative r.f." idea sunk into the cranium from perusal of the old Bane-Hawk super in RADIO. A number of different types of supers were built using both regenerative r.f. and i.f., with the push-pull second detector, appearing at a later date in RADIO, aiding a bit in the noise reduction.

In 1934 a semi-experimental super was built, incorporating practically every idea in super design that could be found. This receiver used the old SW5 tuning apparatus as the basis of the high-frequency section. Eighteen controls in all were on this receiver; fourteen on the front panel, one on the side, one on the back, and even two underneath the chassis. After this receiving contraption was altered a dozen or two times, a simplified version was built using the same electrical circuit but standard construction. Models of this receiver were put into service at W2CPA, W2HFS and other local ham stations. This receiver was eventually described in *Radio News* (Jan. and Feb., 1936). A great many receivers of this design have been built, including one down in Singapore.

The next receiver for dear old AIF was started in Feb. 1936, in the hopes of using it in the DX contest which was to shortly follow. However, the 90 hours of the contest, and more, were employed in constructing the darn thing. The receiver in this article is the one that was begun in the vain hope of using it in the 1936 DX contest, so we will get down to business on what did, and what did not, work.

All the Gadgets

When this receiver was conceived it was hoped that band switching could be employed. Eventually a four-gang tuning unit, as employed in the HRO, was used, together with several sets of the HRO ganged plug-in coil units. The variable selectivity system of the Super-Pro was used, with four i.f. transformers on a single ganged control. Frank Jone's idea of using two i.f. transformers between each of the i.f. tubes was incorporated. Jim Lamb's version of the Scott Taggart noise-peak silencer was also added. A few more features were added just to make the job really hard to build.

The receiver was made to work satisfactorily

—eventually—on the 20-40 meter range, but persisted in oscillating at the most embarrassing times. This condition resulted because the HRO tuning system, Super-Pro variable selectivity and Jone's multi-tuned-circuit idea were never meant to go on one and the same chassis. The ganged plug-in coils located themselves where the controls should have been, the variable coupling mechanism appropriated the resistors' and bypass condensers' proper stations in life, and the oscillation got into everything. Besides, we were never able to grow enough callous on our elbows to tune a dial up in the air. After two trying months we had doubled our left thumb over backwards (extremely painful pastime) during the process of changing bands, so decided that separate plug-in coils and the absence of a selectivity control on the panel would make our DX life a lot happier.

The receiver was finally rebuilt in the form shown in the photos and at last works the way it was first intended to—as proved by an actual cash offer just received for our brainchild!

As stated in the first paragraph, both the set noise and the external noise (auto QRM) are

materially reduced. The best method of reducing set noise, as is well known, is to increase the ratio of r.f. signal-frequency gain to i.f. gain as much as possible. This idea was carried out as far as feasible, two r.f. stages being used, with the first stage regenerative.

The reduction in auto QRM is attained by use of an improved and simplified version of the "noise peak blocking" idea which is so successful for this purpose. The theory and operation of our version of this idea will be taken up in order as the design of the receiver is followed through.

H.F. Section

The high-frequency section of the receiver takes up the entire front portion of the chassis. A glance at the top of the chassis from the rear of the set, as shown in one of the photos, reveals the simplicity of this section. The high-frequency stages in order, from left to right, are: first r.f., second r.f., detector and oscillator. Air-trimmers are located right in the plug-in coils for all stages except the first r.f. This stage has its trimmer mounted on the panel,

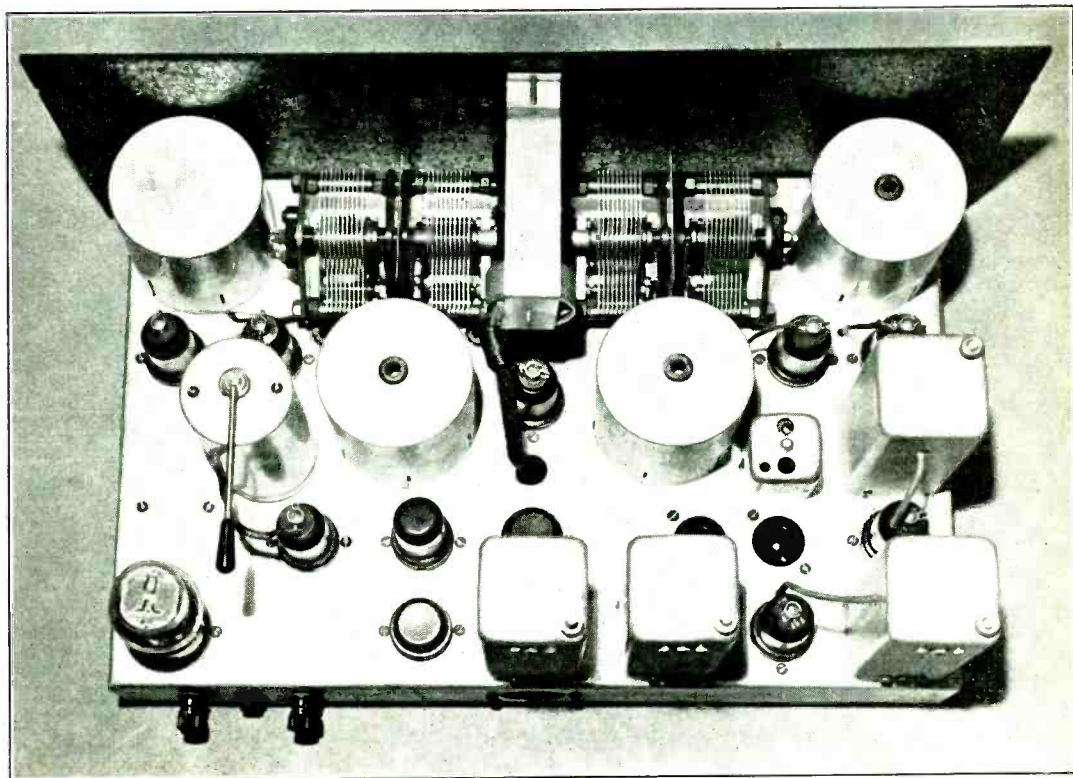

Chassis view of receiver. Note "underslinging" of gang condenser.

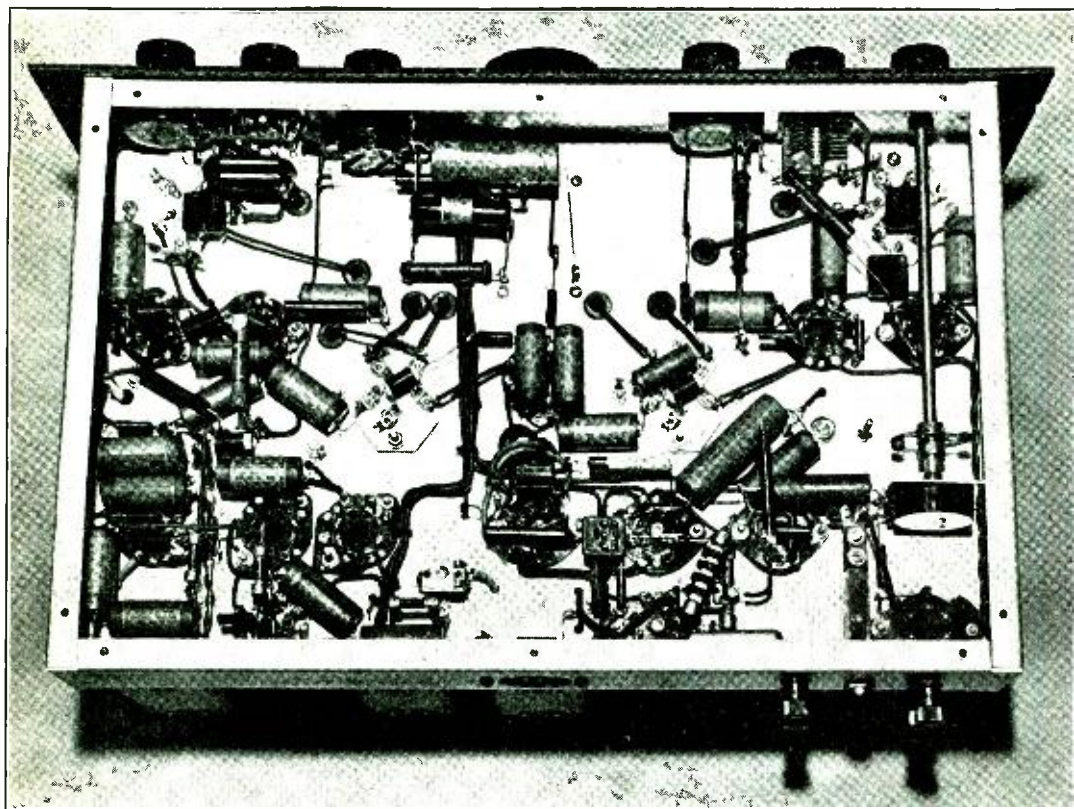

The sub-chassis wiring and layout of components.

so that any slight change in tuning over the range of each coil set, caused by varying antenna impedance and sharpness due to regeneration, may be compensated for.

Two tubes in parallel are shown in the photo for the first r.f. stage, while only one appears in the diagram. The extra tube was a separate regeneration tube, so that the functions of regeneration and amplification could be handled separately. This idea worked perfectly until tried on the ten-meter band. Here the combined high capacities of the two metal tubes prevent oscillation. The regeneration in this stage, however, was most desirable on ten meters, so the separate regeneration tube was taken out and cathode regeneration of the first r.f. amplifier tube itself employed. On the 20-40 and 40-80 meter ranges the additional gain afforded by regeneration is not needed, so the cathode winding prongs on the first r.f. coil sets are shorted. Variation of the screen voltage affords regeneration control on ten meters.

The first detector stage employs a 6L7 tube. Before regeneration was made to work in the

first r.f. stage a 6A8 was used to improve the first detector, in accordance with Clint DeSoto's idea. This tube was not satisfactory on the other ranges, causing what was apparently a self-oscillation. The final successful inclusion of regeneration in the first r.f. stage sounded the death-knell of the 6A8.

The i.f. amplifier section of the receiver wends its way from the i.f. transformer located behind the h.f. oscillator stage around the back corner and along the rear of the chassis over to the glass audio output tube. One fault was found with this "turning the corner" idea in i.f. amplifier layouts. The unshielded grid leads of the 1st and 2nd i.f. tubes are close enough to cause oscillation when the i.f. gain control is opened up. This cause of oscillation was later (too much later, in fact) discovered and corrected with a small upright shield of aluminum between the two tubes. This is not shown in the photos.

Jone's idea of four tuned circuits between stages was compromised with by locating an extra i.f. transformer between the 2nd i.f. tube



and the second detector tube. In the original tube layout of the receiver a 6C5, having a high input impedance, was used. With the present diode second detector the full value of the extra tuned circuits cannot be realized, it being necessary to use tight coupling in both transformers because of the low diode impedance. It would be better to locate the extra transformer between the 1st and 2nd i.f. tubes. This extra transformer is not shown in either position in the diagram, having been removed after the photos were taken. The selectivity with three i.f. variable-coupling transformers is satisfactory for DX reception. In practice, the coupling of the first two transformers is made minimum, while the coupling of the third transformer is set at optimum position, this being about half coupling.

The audio section of the receiver is standard, the only point of interest being the connections of the fone jack. When the fones are plugged in, the 6B5 grid is grounded, d.c. is removed from the fones, and the audio volume control is still effective. This is necessary for earfone operation of a high-gain receiver such as this one.

The electric eye is hooked to the a.v.c. circuit so that its action is practically instantaneous. Thus auto QRM can actually be seen on the eye screen and this likewise permits the operator to witness its suppression. The eye also works on the "c.w.-no a.v.c." position of the combined "beat-oscillator a.v.c." switch.

The Noise Silencer

We now have but the noise silencer to explain. The silencing is all done in the 6H6 second detector-a.v.c. tube. It is a bit difficult to believe that a dinky little "button tube" will adequately handle detection, a.v.c. and noise silencing, but it does—and better than any other system we have tried to date.

The 6H6 is actually two tubes in one tin can. The cathode and plate on the left side of the tube in the diagram comprise one diode section, the cathode and plate at the right being an entirely separate diode section. There is no electrical connection between the two. The left hand diode section of the tube handles the detection and a.v.c. functions in the usual manner. The right hand diode is, however, connected across the detector diode with its cathode and plate reversed. With potentiometer R_{11} (noise silencing control) set at its ground end and the switch on it closed, the plate of the right

hand diode is brought back to ground potential. We have in effect, then, two separate diode tubes hooked in parallel, but in reverse connections. When a signal comes in a negative voltage will appear on the diode plate of the left hand section. Ordinarily this voltage (varying with the incoming signal) would produce an audio voltage. But with the right hand diode section connected in reverse the cathode of this section goes positive to the same degree as the left hand plate goes negative. Any voltage then generated by an incoming signal is therefore cancelled, or balanced, out.

With the potentiometer R_{11} swung over towards its negative end, a negative voltage is applied to the plate of the right hand diode section. The previous perfect balance of the two diode sections then becomes an unbalance for any signal voltages generated up to the value of the negative voltage applied to the plate of the right hand diode. Suppose that this voltage on the right hand diode is set arbitrarily at 10 volts. Any signal, noise pulse or what-have-you which is of such a strength as to generate a diode voltage of *under* 10 volts will encounter a state of unbalance between the diode sections, so that the audio signal voltage will be generated across R_7 , the same as if the right diode section was on a vacation. But the moment the voltage generated is *above* 10 volts the original stage of balance is restored and no audio signal is produced.

The noise control R_{11} , or the gain control, or both, should be set so that the diode voltage generated by the desired signal is *below* the voltage applied to the plate of the right hand diode, but the diode voltage generated by the peak of the unwanted noise is *above* this value. Then during every noise peak the second detector will momentarily balance out, or "block" any generated audio voltage, resulting in the receiver going "dead." During the intervals between the noise peaks the receiver will be restored to normal operation and the signal will come through undisturbed.

If the interfering noise has "instantaneous" peaks, well separated, as is the case with auto ignition QRM, the "blocking" will be so fast and of such short duration that the apparent effect will be that the noise is "removed" and the signal left untouched. It is, of course, necessary that the strength of the noise peaks be above that of the desired signal. The stronger the noise peaks in comparison to the signal, the better the silencing action.

It will be apparent that this noise-silencing

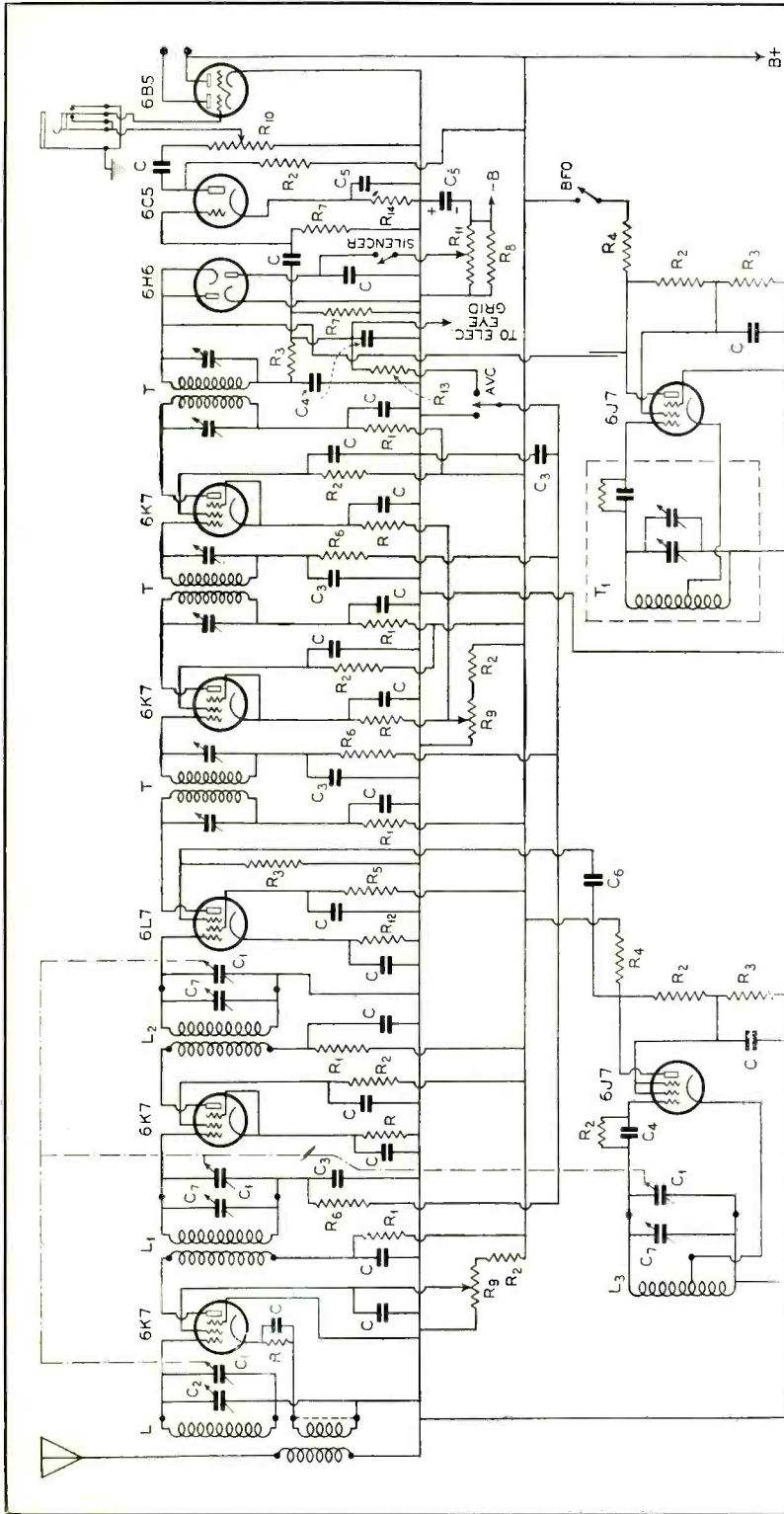

Schematic diagram of the receiver described in the accompanying article. Though not shown, the i.f. transformers have variable coupling. The capacity between the b.f.o. and second detector is formed by paralleling or twisting together two adjacent wires, as shown. The 6H6 functions as detector, a.v.c. and noise silencer.

- R₁—350 ohms, 1/2 watt
- R₂—2000 ohms, 1/2 watt
- R₃—100,000 ohms, 1/2 watt
- R₄—50,000 ohms, 1/2 watt
- R₅—50,000 ohms, 1/2 watt
- R₆—10,000 ohms, 1 watt
- R₇—500,000 ohms, 1/2 watt
- R₈—800 ohms, 10 watts
- R₉—50,000 ohms, pot.
- R₁₀—500,000 ohms, pot.
- R₁₁—10,000-ohm pot. with s.w.
- R₁₂—500 ohms, 1/2 watt
- R₁₃—1 meg., 1/2 watt
- R₁₄—2500 ohms, 1/2 watt
- R₁₅—0.1 μfd., 400 v. tubular
- C₁—225 μfd. (per section)
- C₂—50 μfd., midgest tuning
- C₃—0.1 μfd., 400 v. tubular
- C₄—100 μfd., midgest mica
- C₅—5 μfd., 50 v. electrolytic
- C₆—50 μfd., midgest mica
- C₇—25 μfd., air trimmers
- T₁—Variable coupling I.F.T.
- T₂—B.F.O. transformer



system is practically "foolproof." When properly connected as shown in the diagram it must work—it can't do anything else. As there are no extra tubes or tuned circuits necessary there can be no incentive for the i.f. amplifier to oscillate when it shouldn't. No changes at all are necessary in the i.f. stages, and the normal operation of the receiver is in no way affected. A switch will be noted in the diagram, connected between the plate of the right hand diode and the arm of R_{11} . This switch is the usual type that comes built into a potentiometer. With the noise silencer potentiometer connected so that the grounded end is at the extreme clockwise position of the arm this switch will be automatically closed except when the control is turned to the extreme left. This switch is necessary as otherwise the receiver would block on strong signals when the gain is advanced.

Receiver Layout

A few notes on the appearance of the receiver in the photos are in order. Two vacant sockets and an extra, small i.f. transformer will be noticed. These were used for the original Lamb silencer, which is no longer employed. It will also be seen that there are two 6H6 diode tubes instead of one as in the diagram. This extra socket originally accommodated a separate a.v.c. amplifier tube, which was later discarded. At the time of taking the photo one section only of each 6H6 was in use. A single 6H6 was later made to handle both detection and silencing, as shown in the diagram.

The dial of the main tuning unit is located at the bottom of the panel. In this position the tuning dial knob naturally fits the hand when the arm is laid on the table, so that continual tuning during long DX sessions does not become irksome. Using a tuning gang of 225 $\mu\text{mfd.}$ per section, as is done in this receiver, permits covering any two adjacent ham bands, and all the territory between, on any one tuning range. Covering 20 and 40 meters on one range without changing the plug-in coils will be decidedly convenient in the forthcoming DX contest. Maybe we'll use two separate receivers to cover four bands!!!

It is probable that some hams would like to use this silencer circuit on their present receivers. If the receiver already employs a 6H6 for the second detector a simple change in wiring will do the trick. If not, a 6H6 should be substituted for the second detector and the wiring changed accordingly. Fortunately, the 6H6 is so small that it may be mounted under the

COIL WINDING DATA

COILS	BANDS		
(L) 1st R.F.	10-20	20-40	40-80
Ant. turns	4.2	5.1	14.8
Grid turns	3.2	6.6	14.1
Cathode	2.0	shorted	shorted
(L ₁) 2nd R.F.	10-20	20-40	40-80
Plate turns	3.5	5.5	12.4
Grid turns	3.2	6.8	14.8
(L ₂) Det.	10-20	20-40	40-80
Plate turns	3.5	5.5	13.6
Grid turns	3.2	6.8	14.8
(L ₃) Osc.	10-20	20-40	40-80
Total turns	3.2	6.7	13.7
Cathode tap	1.6	2.7	3.2

Coil forms, Hammarlund SWF; 6-prong for 1st r.f., 5-prong for 2nd r.f. and det, 4-prong for osc. All coils except 1st r.f. use APC-25 air trimmers. All coils wound with No. 24 DSC except primaries L₁, L₂ and L₃ for 40-80-meter range which use No. 30 DSC. Grid windings of 10-20 and 20-40 coils space wound; all other windings close wound.

chassis of any receiver. This was done in converting the receiver of a local ham to this silencer circuit. One of the mounting bolts extending below the chassis was replaced with a longer one, and an octal wafer socket mounted on it high enough so that the 6H6 would just fit between the socket and chassis. As the receiver employed 2 1/2-volt tubes it was necessary to run 6.3 volts in from a midget transformer for the 6H6 heater. The layout of the particular receiver being converted will dictate the easier method of installation.

Harmonic Chasing

If the 160 meter phone hams between 1950 and 2000 kilocycles who live in large cities would call CQ "160" it would save some of the 75 meter fellows from wasting a lot of breath. Of course after one memorizes all the 160 meter harmonics one knows better than to answer one of the CQ's from these 160 meter stations except when they CQ 75 meters. But in the meantime the 75 meter fellows waste lots of time trying to "raise the harmonics."



Hammanners

By UNCLE DUDLEY

The Class A mental giants of the Dark Ages were quick to learn that one of the chief obstacles to the setting up of an R9-plus civilization was lousy manners. Just when it looked as though people were hitting it off well within the bands of social propriety, some lids would arrive on the scene and QRM the works. That was a signal for the high-hats to spit on the low-brows for being that way—and, of course, high-hats can't go around spitting indiscriminately and expect it to be a good lesson.

But the mental giants didn't know what to do. However, some centuries later, Pappanopis thought he had the solution to the problem. Having seen one civilization blow its condensers, he set out to preserve the p.d.c. note of his own country by establishing an off-with-their-heads policy. This decree so frightened the population that it retired to underground cellars and ate sparingly of humming-bird tongues. And so another great nation faded into the mud.

Many sun-spot cycles passed before the arrival of the Emily Post era of standardized etiquette for people suffering from brain-block. This etiquette-out-of-a-book was indeed an innovation, and quite a success, too, because the whole plan was based on the assumption that, as Emily herself might put it, "The poor duds don't know no better." It was Miss Post's belief, in other words, that there were plenty of Typhoid Mary's floating around inadvertently spreading lousy manners. They needed to be taken in hand and shown the light, and, if possible, changed from carriers into useful citizens. The result has been in our enlightened civilization of this here twentieth century that the majority of the people use knives for cutting rather than carting food.

If Emily Post were a ham, her influence would no doubt be felt in the ranks. There might be ribbons on our tank coils and perfume atomizers built into our mike stands; phone men might differentiate between "who" and "whom," and c.w. men might consider "88" as being just a bit too "riskaay." But it is a question if even Miss Post herself would stick to the dictates of ham etiquette once she got her mitts on a mike. Miss Post would, in other words, fail to realize that a phone station is not

a party line, and proceed to talk her pretty head off. And then the high-hats might commence spitting. . . .

Actually, Ham Etiquette is a highly rarefied species of deportment having no connection with instinctive social manners or the "boughten class" employed as a surface insulation by the hoi polloi. Ham Etiquette, if anything, is a rather "technical technique" that is so much Greek to the uninitiated. As a result, the newcomer, and even many of the more experienced hams, are in constant peril of overstepping the line of propriety and triggering-off a high-class spitting bee. When they do, they suffer the incriminations of their fellow hams with deep indignation for the reason that they are unaware of having made a "*faux pas*", or "fox pass" as a friend of ours pronounces it.

That's a situation that calls for correction, but by the use of Castoria rather than Croton Oil. An off-with-their-heads policy can only make a clan of Caspar Milquetoasts out of the newcomers, and that won't serve to make Ham Radio very vital. A few kind words from Uncle Dudley might be a more appropriate medicine.

To begin with—a ham band is not like a subway car. You can jam just so many people in a subway car and no more, but you can jam an unlimited number of sigs into a ham band. That there is interference as a result is often accepted as an evil fact beyond the control of mere mortal, and the acceptance therefore construed as a license to clutter a channel. There is apt to be dynamite in such an attitude.

The idea, if you haven't thought of it, is to minimize QRM rather than assume a sense of hopelessness and let things take their own course. There are ways of improving conditions without becoming a hermit and without necessarily cramping your style. Like manners, it's a case of conforming to established custom and of viewing the other fellow's problems in the light of your own.

So let's couple the old mental oscilloscope to the situation and see what comes into view.

Here's the case of Joe Fussbudget, who simply can't leave his phone rig be. Joe is fraught with the fear that "something may have happened" since he last worked a station. Joe can't bear the thought of using the rig again until he is sure everything is okay.



So, what does Joe do? He puts on the carrier and fiddles a bit with the controls, views with concern the meter readings, whistles into the mike and repeats the time-worn, "one-two-three-four-test." After five minutes of fiddling, he may decide the rig is in proper working order. He has, to be exact, arrived at the opinion that his signals will stand the rigid inspection of the listening hams. So he opens up with a CQ or a short, snappy commercial-like call for the fellow at the end of town. He is satisfied as he pulls the carrier that there are certainly no flies on him or his signals.

But Joe is covered with flies. His friend at the end of town was in the midst of a QSO when Joe commenced his fiddling; three other QSO's were interrupted, and the ham who suspected he had Tasmania in the shadow of Joe's frequency swore he would give up radio and enter a monastery.

The boys could forgive Joe if he ate with his knife, but never will they forgive him for unnecessarily jamming a channel. It is one thing, the boys figure, to be QRM'ed by a legitimate call or QSO, but quite another thing to be put out of commission by a futile carrier.

If Joe had the sense he was born with, he'd use a dummy antenna when testing or adjusting his transmitter, or *at least* listen to his own channel to make sure it is clear before putting his carrier on the air.

Then there's the case of Bill Hipower who has a honey of a transmitter but a lousy receiver. Bill can't hear what he is able to raise. Every time he opens up, a flock of DX boys call him, but Bill never answers. The local boys are busy trying to hook their own DX with the net result that Bill unknowingly raises a beehive of QRM out of which nothing constructive is derived.

Bill should reduce his power, get a better receiver or install a changeover relay so that he can use his tuned antenna for reception as well as transmission. The use of the transmitting antenna matched to the receiver would at least pull a few of the DX stations out of the mud and give Bill the opportunity of working some of the hell he raises.

The case of Tom Higain is about as bad. Tom has a supersensitive single-signal receiver with tuned antenna, but a peanut-whistle transmitter. He hears stations he can't possibly work, but he never ceases attempting to raise them. He never gets to first base with these boys, but the almost constant use of his peanut whistle covers all three bases locally and causes QRM.

The trouble with Tom is, he's too optimistic

to consider the shortcomings of his transmitter. The local fellows wish he'd throw his peanut whistle into the ocean and dive in after it.

One would imagine Norman Duplex had the leprosy the way the local and first-skip hams shun him. Norman has a phone station that would fire the heart of any ham, yet Norman is practically an outcast. It's all very strange—to Norman.

The trouble is that well-meaning Norman just dotes on duplex operation and is always alert for an opportunity to give it full play. He has been known to leave his carrier running for as much as an hour, and in that period completely monopolize an otherwise active channel. Strong men have fallen asleep or developed nervous indigestion (depending on their temperaments) waiting for Norman to finish functioning as a relay center for a couple of fellows a thousand miles off but separated from each other no more than the limits of their respective ground waves. It's all very thrilling to Norman, but a downright nuisance to everyone else.

Norman should learn that duplexing is appreciated when used in a manner that will expedite a QSO, but very seldom otherwise. Rapid-fire break-in might be more to his liking if he'd give it a fling. It would be more to the liking of his potential friends and would certainly eliminate a lot of channel cluttering.

The case of Timothy Brainblock is quite a common one. Timothy also has a phone rig and he works it whenever he has the time. He studies his school books during the late afternoon but gets on the 20-meter band in the early evening while the band is still plenty hot.

Tim is what you might call a "snatcher." It is his habit to wait for a ham in his own town to finish calling an LU or an SU and then break in with, "Say, OM, if you don't hook that station you're calling, how about coming back to me? I haven't anything to do. I've just been messing with this receiver of mine, etc., etc." Since Tim's signal splashes a bit, the result is disastrous.

But Tim's real failing is in another direction; once he starts a QSO he is seldom able to carry it to a successful conclusion. There is forever present the youthful urge to tinker and it is not uncommon of him to place his carrier on the air and throw out a few one-two-three-four's while the other end of the QSO is still talking to him. Then, as likely as not, Tim will be caught napping when he gets the K. This necessitates another call and an inquiry as to what is wrong and it usually turns out that Tim forgot to re-apply the plate voltage to the



receiver and in consequence completely missed the thread of the conversation.

Tim has managed to cram enough book learning into his skull to grab himself a Class A ticket, but he has yet to gain the maturity that carries with it a sense of obligation. Until he does it may be expected of Tim to do the wrong thing at the wrong time and thus create a nice smear of needless QRM.

Peter Beatnote works the 40-meter band and has a crystal that puts him at the high-frequency end. Instead of confining his listening to within a few hundred kilocycles of his own frequency, Peter wanders off to the middle or low end where he hears stations he'd like to contact. So Peter follows through with three-minute calls for stations whose operators are scanning frequencies far removed from that of Peter's crystal. Thus Peter's useless signals add to the general QRM and break up the Lord knows how many potential contacts for other hams.

Peter should confine his listening to the vicinity of his own frequency or provide means for shifting his frequency into the territory of a desired station.

No collection of case histories would be complete without that of C.Q. Codephone who works all bands on c.w. and phone. This chap is so taken with his own initials that he considers his station call of secondary importance. He lives to spout CQ's and it seems to make little difference to him whether you catch his call or not. In any event, it is his habit to offer them to the listening world at a ratio of fifteen-to-one. As a rule he has faded into the mud or been covered by QRM by the time he condescends to give his call. There is, therefore, a chance of only 1 in 30 of most hams determining who's doing all the CQing.

The least this chap Codephone could do would be to alter his ratio to the accepted 3-3 and give the fellow at the listening end a sporting chance. Failing in that, Codephone is not only adding to the general QRM but severely reducing his own chances of making DX contacts.

Last, but not least, is Geo Harmonica who works on two bands simultaneously. He only *wants* to work one band, but he sets off a raft of hams calling his second harmonic. The F.C.C. will get him if he don't watch out, but in the meantime he is creating multiple QRM of a useless nature in a band in which he himself does not work.

No one has told Geo that he is a Typhoid Mary, but when he learns of it we can be

sure he will take steps to get rid of the second harmonic.

Good manners coupled with a knowledge of correct station operation would relieve the ham bands of 25 per cent of the QRM. The other 75 per cent can't be helped, but there is at least some satisfaction in knowing that it is necessary. It's the 25 per cent *waste* QRM that hurts. Futile is the name for it.



International Contest Sequel

Drst Mrgt:

It sms yrs since I last gzd upn ur bttl face and lkd into ur wndrfl ize. Evy min of the 4 wks U hv refused 2 c me has smd an etrnly.

I tnk abt U fm the min I wake up til the min I go to slp es even then I drm abt U. Lfe widout U is mnnglss. I hve almst died fm dspr es unhappnss, es fear tt U mite hv fnd anoder swthrt. QSL es tell me tt U r still mine es no others. I QRX fr ur ltr on pns es ndles. QTS? If okay QTU? 88.

Ur lvng Hrbt

P.S.—I prmse nt 2 entr cntst nex yr—hnst!



Until the Doctor Comes

One of the best emergency supplies of sheet aluminum is the common "cookie sheet". For instance we bought some "Wear Ever" No. 133 sheets at 6 bits each. They were of .039" aluminum, 12" x 16" with one short edge turned at right angles, the turned-up part being 1/2" wide. The sheets are thoroughly flat (how different from some other kinds) and the edges are well finished. John Reinartz told us about it. Get them at the household furnishing department or (as the announcers say) you may write directly to The Aluminum Cooking Utensil Company at New Kensington, Pa., or Oakland, California—and we hope they answer your letters. They didn't answer ours.



Short Haul Tfc.

Zeb Willits, the only ham in Horse Trough Gulch, got himself a store-boughten 5-meter rig and has been complaining of lack of QRM. Zeb figures the only way he will be able to work anybody is to tie the rig to the old high-wheeler, peddle to town of a Sunday, and work some of the city fellers.

The Neobeam Oscilloscope

A good deal of interest has been given to gaseous tube oscilloscopes in the last year, and while the basic principles are not new, some of the recent developments are.

The essential part of one of these oscilloscopes is the tube itself, and an understanding



Figure 1: The Neobeam Glow Tube

of the principles of gaseous discharge tubes is necessary.

Gaseous discharge tubes are roughly divided into two classes—direct discharge tubes and glow tubes. In the direct discharge type the conduction of current is directly between electrodes and through the ionized rarefied gas; a neon sign is an example. In the glow type the direct discharge is usually limited by design as much as possible and the discharge is confined to a glow on the electrodes only. The familiar glow lamp is an example. The gaseous oscilloscope tube belongs to the glow type.

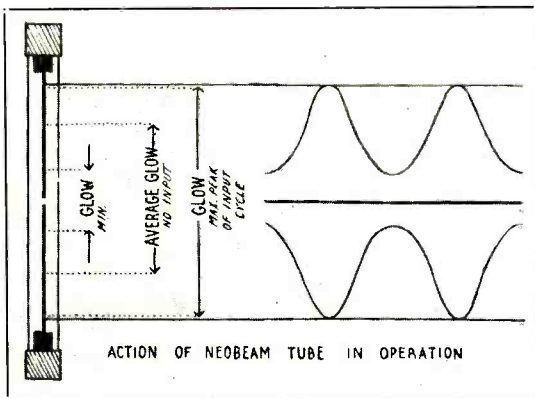

Figure 2

Going back to 1861 we find that Feddersen discovered the area of glow covering the electrode of a gaseous discharge tube was directly proportional to current passing through the tube. It had been discovered earlier than this that only the negative electrode glows. In 1904 Gehrke and Disselhorst combined these two

principles to produce an oscilloscope by using a tube with elongated electrodes and a rotating mirror to scan the electrodes across them. The construction of the tube is shown in figure 1. Since only the negative electrode glows, on alternating current the glow shifts from one electrode to the other at a rate equal to the impressed frequency. The same setup has been used recently to check modulation in amateur transmitting.

The early type gaseous tube oscilloscope has

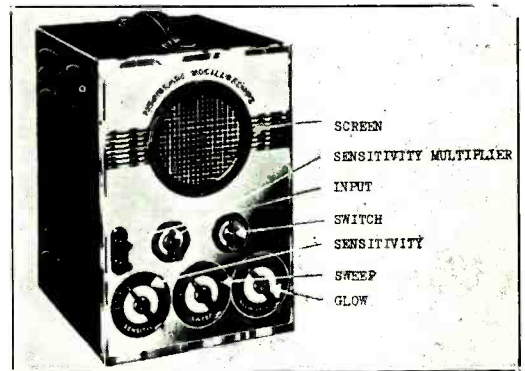

Figure 3

several inherent disadvantages. In the first place, the easily ionized rare gases were practically unknown and nitrogen was usually used as a medium. The high ionizing potential of nitrogen limited the use of the instrument to the observation of relatively high potentials such as condenser discharges. Even with neon or the other rare gases the lowest practical striking voltage obtainable is about 200 volts d.c., and about 10 ma. is required to operate the tube at full cathode glow. These values are entirely too high for practical use as an all around oscilloscope.

In the new "Neobeam" oscilloscope this difficulty has been overcome in a unique manner. Instead of making the electrodes glow directly from the input voltage a 6L6 radio frequency oscillator is provided to keep both the electrodes glowing all the time. This changes the entire picture. The disadvantage of high striking voltage is eliminated, but more than that, an amplifier and modulator may then be used to modulate the oscillator, which in turn

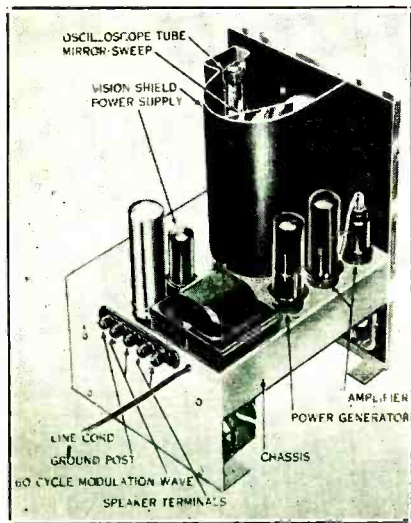

Figure 4

causes the glow on the electrodes to rise and fall in direct proportion to the input to the amplifier. Viewed in a scanning mirror an image is shown like figure 2. The tube is comparatively small, 6" long by 9/16" dia. The elongated electrodes measure 2" each, thus permitting a 4 inch image. Distortion in the input is portrayed by changes in the wave outline. Thus instead of 200 volts and 10 ma. minimum to operate the tube, we use inputs of as low as 1 microvolt across an input potentiometer of 1 megohm and obtain 100% modulation. By means of a built-in multiplier switch the range is extended to 200 volts. The number of applications for the instrument by these methods is greatly extended. The finished instrument and

internal views are shown in figures 3 and 4 respectively.

Since the upper limit of frequency response of a gaseous oscilloscope tube is about 10,000 cycles, the use of the Neobeam is in the range below these frequencies. The scanning mirror is driven by a constant speed induction motor with an adjustable friction disc clutch. The speed of scanning is calibrated directly in r.p.m., an especially useful feature in making quick frequency determinations. Frequency is determined by the simple formula

$$f = \frac{\text{R.P.M.}}{L_2}$$

where f = frequency, R.P.M. = sweep, and L = distance between cycle peaks in inches. To facilitate measurements the image is observed through a screen calibrated in 1/4 inch spaces.

In demonstrating wave form it is often desirable to hear as well as see the input signal. For this purpose a speaker connection is provided. See figure 4. With the speaker connected the instrument becomes in effect a small public address system capable of direct input from a crystal microphone on the input and a 5 watt speaker on the output. While this feature has its uses in making demonstrations in a large class room, its greatest usefulness lies in the fact that distortion can be shown visually that would be impossible to detect audibly. A very practical use lies in demonstrating and comparing the fidelity of different receivers with the same signal input. In teaching work it is used to show the effect of timbre on tones of similar pitch. This outlet also provides a connection for self-recording equipment.

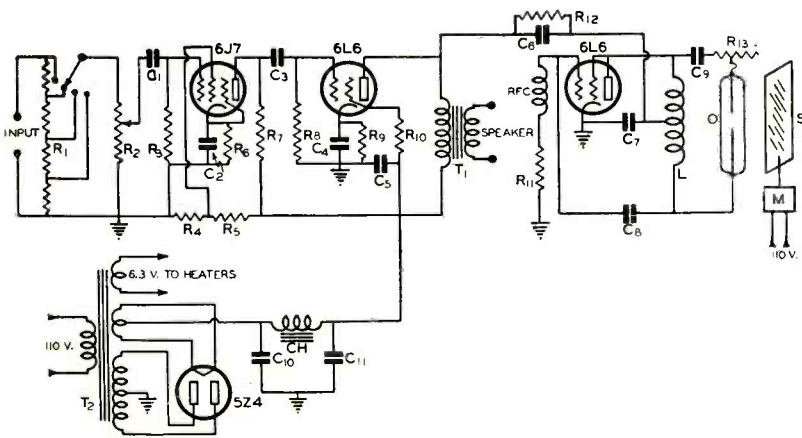

- C₁—.01 μfd.
- C₂—12 μfd.
- C₃—.01 μfd.
- C₄—12 μfd.
- C₅—1 μfd.
- C₆—0.1 μfd.
- C₇—.00025 μfd.
- C₈—.00025 μfd.
- C₉—.00025 μfd.
- C₁₀—8 μfd.
- C₁₁—8 μfd.
- R₁—1, 150, 500 ohm divider
- R₂—1 meg. pot.
- R₃—1 meg.
- R₄—20,000 ohms
- R₅—100,000 ohms
- R₆—250,000 ohms
- R₇—500,000 ohms
- R₈—200 ohms
- R₉—50,000 ohms
- R₁₀—100,000 ohms
- R₁₁—100,000 ohms
- R₁₂—1/4 meg. pot.
- S—Sweep
- O—Neobeam tube
- M—Motor
- L—100 kc. oscillator coil; c.t.

Figure 5: Wiring Diagram of the Neobeam Oscilloscope

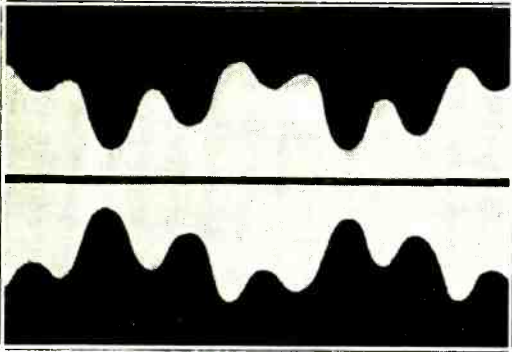

Figure 6: A Voice Wave Passed Through an Amplifier

The circuit diagram of the Neobeam Oscilloscope is shown in figure 5. The input signal is fed into a resistance shunt and potentiometer arrangement to permit inputs from 1/1,000,000th volt to 200 volts.

The first amplifier stage is a 6J7 high-gain amplifier with the constants set to secure the highest possible gain and still retain linear amplification characteristics. The modulator is one of the new 6L6 beam power tubes and the oscillator is also the same type. The oscillator is set at 100 kc. and serves to keep the oscilloscope tube constantly ionized.

The pattern shown by the Neobeam is the modulated wave type—that is, each half cycle is shown double symmetrically about the zero axis. Thus a sine wave is shown as in figure 2. Changes in wave form are shown by the outline and a 320 cycle complex wave is shown in figure 6.

The uses of this type of oscilloscope are far too many and varied to cover in this article. While it does not have the high-frequency response of the cathode-ray oscillograph its simplicity and good response to audio frequencies open fields for its use by non-technical laymen who could not operate the more complex forms of oscilloscopes.

In radio broadcasting it is used for checking modulation, excitation, line levels, amplifier gain feedback, and for tuning. In radio servicing work it is used for balancing receivers, hum tracing, checking distortion and fidelity, and for making sales demonstrations.

Quartz crystals were used experimentally in telephone work and submarine signalling long before their application to radio.

MODULATION HINT

Phone amateurs who are hyper-critical about their quality should, in addition to using grid-leak bias, make sure that the grid bypass (or "blocking") condenser is not too large on the modulated stage (referring to plate modulation). This is seldom the case with capacity coupling, because the coupling condenser is seldom over 0.001 μ fd. But in link coupled circuits many amateurs use 0.01 μ fd. and even larger in order better to "tie down" the cold end of the grid coil.

It is very difficult to get perfect linearity with just battery bias. Either gridleak or a combination of battery (just enough to bias to cutoff for protection) and gridleak bias should be used.

If a very large bypass condenser is used in the grid circuit of a link-coupled stage, the effect at audio frequencies will be the same as if batteries were used for bias. The static linearity may check o.k., but the large condenser will not allow the grid bias to change over the audio cycle as would be the case with a smaller bypass condenser, and the *dynamic* linearity will be no better than if battery bias were used. Use as small a condenser as you can get by with and still neutralize the stage properly.

Way Out West

Out in Californy the amateurs do things in a big way, whether it is kilowatts or towers. Our frontispiece shows one of the towers. It has no guys; the only wires attached to it are two antennas, both pulling in the same direction. Yes, that is really a man up towards the top.

We have been trying to flush up a California Kilowatt so we could set a picture of one to show you. Unfortunately, to date we have been unable to scare up one. We know they exist, because we have heard them at night giving their mating call (usually a shrill whistle with a 240 or 360 cycle whine superimposed). One of these days we shall track one to its lair and get a photo for you.

Incidentally, we understand the R.I. has an expedition in the field searching for these elusive animals. He reports that the hounds have picked up the scent several times, but have lost it again. The R.I. asked us if we knew the address of a good taxidermist he could get to stuff one of the animals after catching it. We told him we knew a lot of east coast amateurs who would be glad to do it for nothing.



An Inexpensive, Low-Power Phone-C.W. Rig

By KENNETH L. KIME, W6KSX*

This transmitter was designed for portable use on phone and c.w. and also as an exciter to drive a larger tube on c.w. The audio section was to be used on five meters with a separate r.f. unit; so provision was made to "plug in" for the various uses. This made the rig universal in its

As long as we must have an exciter anyway, why not build it up so as to be portable, thus making a portable low-power rig? And while we are at it, a modulator unit for such a low-powered rig is a very simple affair, especially if a single-button mike is used. Following this line of reasoning, the neat appearing unit described in this article was built.

wire antenna or Collins network. The two feed-through insulators on the right are for link coupling

to the antenna or to another buffer or amplifier, which I do to drive a 211 on 80 meter c.w. The long window at the top is cut from tempered Masonite and small-mesh chicken wire fastened to the frame. This window snaps out to permit coil and crystal changing without removing the dust cover. The jack on the left is in the cathode of the 53 and for c.w. the key is plugged in it. The first dial on the left is the crystal plate tank; the middle dial is for the doubler plate tank; and the dial on the right is the final plate tank, with the jack for the final plate current to the right of that.

The middle panel holds the 53 modulator and speech assembly. It has a 0-100 milliammeter mounted in the center and to the right of that is a s.p.s.t. toggle switch to short out the output side of the class B transformer when operating c.w. The jack on the lower left is for the mike; the control just below the meter is the gain control; and the jack on the right is the class B plate current.

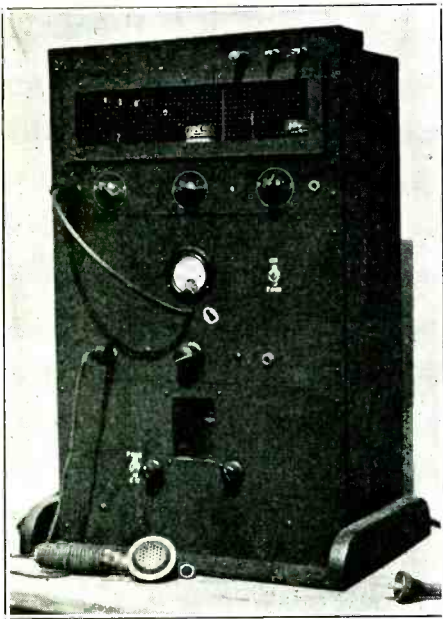

Front View of the Complete Transmitter

adaptations, and the mounting of the different components in a neat but inexpensive rack brought it up to date and out of the "bread-board" class. There are no exposed parts to be dusted off periodically, and no hay-wire showing to the critical eye.

There is nothing new in the circuit used in this rig: just a Jones exciter, as an r.f. unit, a 53 class B modulator, and a conventional power and bias supply. The physical layout is simple. Starting at the top panel, the left-hand feed-through insulator is for connecting to a single-

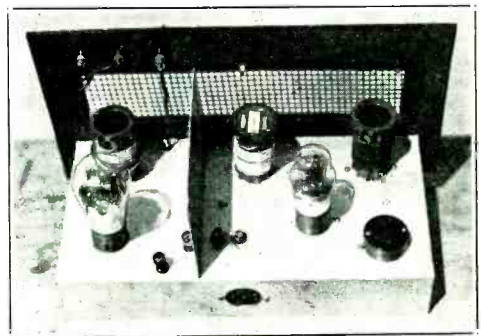

The R.F. Section of the Transmitter

The bottom panel holds the power and bias supply. The 83 rectifier can be seen through the small window, which is covered with copper screen wire. We always did like to see an 83 flare up on modulation peaks. The toggle switch on the left disconnects the power supply from the modulators for c.w. operation. The switch knob to the right is in the negative power lead

*2305 Oakwood Ave., Venice, Calif.

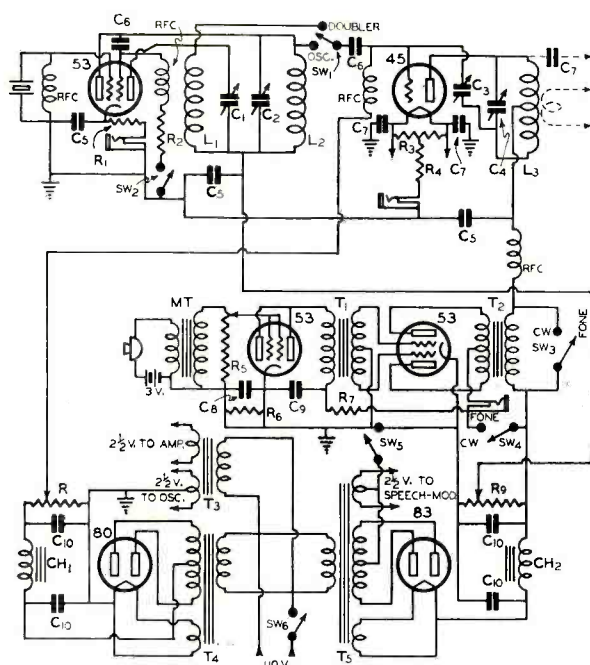

Wiring Diagram of the Complete Transmitter

- C₁—50 μ fd. midget
- C₂—140 μ fd. midget
- C₃—25 μ fd. midget
- C₄—50 μ fd. midget
- C₅—.01 μ fd.
- C₆—.0001 μ fd. mica
- C₇—Optional coupling condenser for capacity coupling to another stage (size depends upon tube used)
- C₈—10 μ fd., 25 volt electrolytic
- C₉—.05 μ fd. tubular
- C₁₀—8 μ fd. electrolytics
- R—10,000 ohms, 25 watts
- R₁—400 ohms, 10 watts
- R₂—25,000 ohms, 10 watts
- R₃—20 ohm c.t. resistor
- R₄—300 ohms, 10 watts
- R₅—.025 meg. gain pot.
- R₆—1000 ohms, 1 watt
- R₇—15,000 ohms, 10 watts
- R₈—25,000 ohms, 50 watts
- CH₁—30 hy., 60 ma.
- CH₂—20 hy., 300 ma.
- MT—Mike transformer
- T₁—53 class B driver
- T₂—53 class B output to class C load
- T₃—2.5 volt fil. transformer
- T₄—Midget b. c. l. transformer, 60 ma.
- T₅—400 v., 250 ma.

for transmit and receive, and the knob on the right turns on the power and bias supply.

The power and bias supplies are conventional and can be taken from the *Radio Handbook*. I installed a bias supply to do away with batteries; it makes the rig more flexible and is a decided convenience if it is desired to work portable.

The panels are made of Masonite (tempered), sixteen inches long; two are eight and one-half inches wide and one—the power supply panel—is eight and one-fourth inches wide. They are fastened to the chassis with two bolts near either end of the chassis.

The rack is made of soft pine. It is sixteen inches by twenty-five and one-half inches outside measurement and each corner is reinforced with a metal angle purchased at the "dime store". The rack is very rigid and strong.

The strips that support the chassis are one inch square and three and one-half inches long and are fastened to the sides of the rack with wood screws. One above and one below each end of the chassis relieve the panels of all weight.

The panels are fastened on with short wood screws and the ends of the panels are trimmed flush with the sides of the rack.

The whole assembly was painted with Sherwin-Williams "flat black for wrought iron". I find this leaves a satin finish and does not turn grey. It closely resembles rubbed bakelite.

The chassis are cadmium plated, fourteen inches by seven and one-half inches by two and one-half inches, purchased at the local supply house.

Referring to the back view with the dust cover removed, at the top the 45 final is on the left with the 53 oscillator and doubler on the right. The middle chassis has the class B output on the left, 53 modulator, the intermediate transformer back of the flashlight cells for the mike battery, and the parallel 53 speech amplifier on the right. The power plug, to the left of center, carries the positive voltage to the output side of the class B transformer and then on up to the final amplifier. This was installed separate from the other plug in order to plug in the five-meter oscillator and use the 53 class B modulator on five meters. The bottom chassis shows the power supply with the 80 bias rectifier on the left with the main power transformer back of that. Then the bias choke and to the right of that the filament transformer and next to that the 8-8- μ fd. filter condenser. The

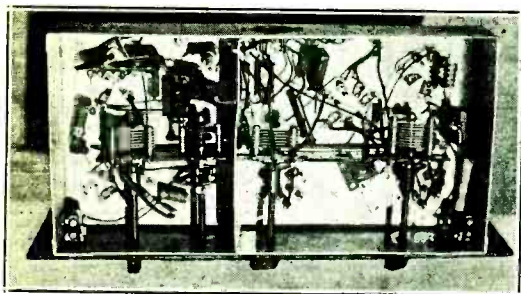

Under-Chassis View of the R.F. Section

bias transformer and main filter choke are against the front panel and do not show.

This illustration also shows the method of mounting the chassis on the rack. The 1" square strips extend back from the rack about one inch to hold the dust cover, which is held in place by four wood screws in these blocks from the side. The dust cover is made of the same Masonite and is reinforced and held together at the back edges with 1" strips running the full length of the cover. Holes are drilled in each side to provide ventilation.

Referring to the layout of the r.f. unit, the crystal is in the lower right, crystal plate tank coil upper right, 53 right center, doubler plate tank top center, and lower center is the double-pole double-throw switch which cuts the doubler in or out. The two binding posts to the left of the shield are for external bias batteries and should have a jumper across them now that

the bias supply has been installed. Back of the 45 is the final plate tank showing the two-turn coupling link and also the single-wire-feed to the right of that.

The photo of the under side of the r.f. unit shows the method of mounting the different components. The tuning condensers are mounted on a bakelite strip which runs nearly the length of the chassis, and are connected to the knobs on the front panel with bakelite shafts. If the holes in the strip do not quite line up with those in the chassis when drilled, use a flexible coupling. The jack in the upper left corner is the cathode current jack, with the cathode resistor and by-pass condenser coming back from that. In the lower-left corner are the crystal socket and r.f. choke and in front of them is the crystal tank condenser with the coupling condenser to the grid of the doubler.

In the top center is the socket for the doubler plate coil and below that is the doubler tuning condenser, with the doubler grid leak to the left of it. The d.p.d.t. switch is just in front of the power plug.

On the right side of the shield we have the neutralizing condenser in the center with the grid coupling condenser and r.f. choke below that. In the upper-right corner is the plate cur-

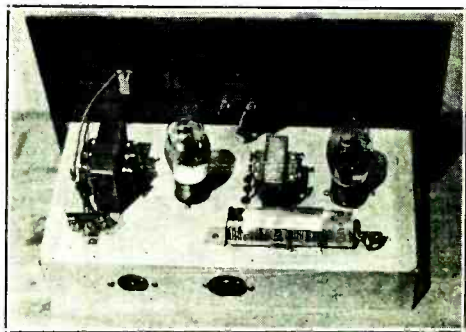

The 12 Watt Speech System

rent jack and from it goes the 300 ohm resistor to the filament center tap resistor mounted on the tube socket with two by-pass condensers to the left.

This layout is very easy to build and makes a neat appearing unit when completed; plate and grid leads are very short, more, in fact, than they could be if the condensers were mounted above deck. It puts all the wiring underneath where no one can see it unless you have the courage to show them. The smallest amount of

COIL TABLE			
Band	Osc. Coil	Doub. Coil	Amp. Coil
160 meters	50 t. no. 28 d.c.c. close wound	None	60 t. no. 28 d.c.c. close wound and center-tapped
80 meters	28 t. no. 24 d.s.c. spaced dia. of wire	None. When doub. from 160 m. xtal use 80 m. osc. coil	34 t. no. 20 d.c.c. close wound and center-tapped
40 meters	14 t. no. 20 ena. spaced twice dia. of wire	None. When doub. from 80 m. xtal use 40 m. osc. coil	16 t. no. 20 ena. spaced twice dia. of wire and center-tapped
20 meters	None. Use 40 m. crystal	7 t. no. 20 ena. spaced twice dia. of wire	8 t. no. 20 ena. spaced twice dia. of wire center-tapped

Coil forms used are 6-prong receiving type, 1 1/4" dia.

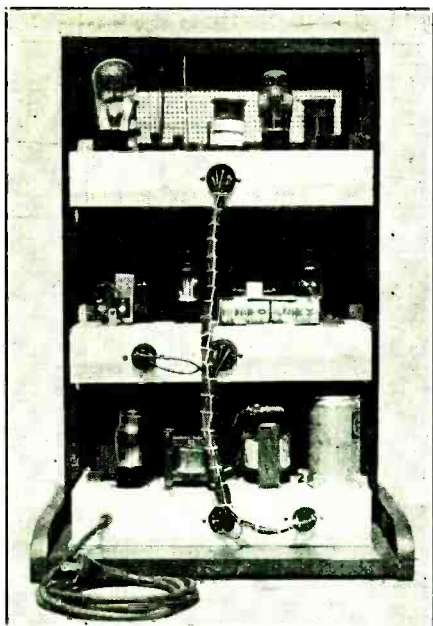

Back View of the Complete Transmitter

shielding was found necessary with this unit.

The modulator circuit is conventional in all respects and the layout just as simple. The class B output transformer is on the left and below it is the terminal strip to select the output impedances of 3000 or 5000 ohms. Above the transformer on the panel is the toggle switch which shorts the output side for c.w. The mike transformer is mounted beneath the chassis. I haven't had any bouquets thrown my way on the quality of the speech but seem to be understood and get good single-button mike reports, which is all that can be expected considering the microphone and parts used

Tuning Up

Tuning up is very simple: Insert a plug into the final plate jack, tune up the crystal and neutralize the final on the crystal frequency, leaving out the doubler. Then tune up the final after removing the plug. In order to tune up the doubler, the final amplifier must be left running to provide a load. The neutralizing control can be noticed in the front view between the buffer knob and final tuning knob. The end of the bakelite shaft was cut off flush with the panel and then slotted. Once set, the neutralizing adjustment need never be changed. The final loads up to twenty watts and operates very well; no frequency modulation has been

noticed or reported. The output seems to be about the same on all bands. On eighty meter c.w. I use this exciter to drive a 211 and on ten meters to drive an 802, doubling from twenty to ten in the grid of the 802. I have worked the east coast on eighty meter c.w. with this exciter alone; so there must still be some hope for the low-power gang, and I hope this information will help some of them to improve their rigs and dress them up for the coming season.

Modulating 807's and RK-39's

A local ham recently phoned our technical department to see if we could tell him why his new transmitter "which is built just like in the article" didn't work right. It was a phone rig, and sounded intelligible enough, but looked terrible on the 'scope and had rather mediocre quality.

When we discovered that it was not a rig that had been described in RADIO we told him we were sorry but couldn't help him in that case, but the next day he showed up at the laboratory with the whole transmitter, and was so insistent in a nice way that finally we took a look at it, largely because by that time we had become curious ourselves.

A check revealed that the audio system was working very well. Upon checking the linearity of the modulated stage, however, it was found to be sadly lacking. The transmitter used a pair of the new transmitting-type beam tetrodes in the modulated stage, plate modulated with *fixed* screen voltage. The bias came entirely from a cathode resistor, by-passed for r.f. but not audio. In other words the bias was varying during modulation from almost zero to nearly twice the unmodulated value.

The screen voltage was changed over to a series-dropping resistor arrangement off the modulated plate voltage. A 20 μ d. 100 volt electrolytic was put across the cathode resistor as an audio bypass. Result: the transmitter no longer "modulated down"; it sounded very good, and looked very respectable on the 'scope.

Now that these tubes are becoming widely used, we would like to point out that for best results they should be *plate-screen* modulated, and that the cathode bias resistor (if used) should be bypassed for *audio* if the rig is used for phone work. If additional bias from a grid leak is used, it is then not quite such a serious matter, but it is still wise to bypass the cathode resistor with 10 or 20 μ d. for phone work.



Wattage Input Vs. Load Impedance Chart

This chart is designed to enable the user to determine without computation the wattage input to any tube or tubes and the load impedance which any modulated stage presents to the modulator. The latter is of special importance, since improper matching of the modulated tube may be the cause of low audio output, high harmonic distortion, or both.

As a general rule, when using a Class B or Class AB audio system, if the impedance of the modulated tube is higher than that for which the coupling transformer is designed, the harmonic distortion will be low, but the power output will also be reduced. If the load impedance is low, the harmonic distortion will be greater, as will be the power output.

The modulated tube acts as a resistance which can be varied by changing either the plate voltage and current, or both. Of course, the rating of the tube should not be exceeded.

Remember that the audio power is added to the d.c. plate input power, and that if a tube is operated at its maximum capacity when unmodulated, it may fail when modulation is applied.

Two graphs are combined on this page. The straight dotted lines are a family of curves showing input wattage. The proper plate voltage line is followed until it crosses the vertical line representing plate current, and the input wattage may be read directly from the left margin.

The load impedance is shown as a family of curved solid lines. The proper voltage curve is followed until it intersects the required vertical plate current line, and load impedance is read from the right margin.

By placing a ruler horizontally across the chart, the operating conditions to secure that load may be determined by reading the plate current at the bottom of the page directly under the intersection with the various plate voltage lines.

Example

Assume that we wish to use a pair of 03A's class B to modulate a transmitter with 852's in the output. The modulator unit is capable of supplying more than the 200 watts of audio power required to modulate fully 400 watts input. The secondary of the output transformer we have is matched to a 10,000-ohm load with the secondaries in series, or to 2500 ohms with the parallel connection. Following the horizontal line of the chart marked 10,000 ohms across until it intersects the proper voltage line (in this case the 852's are operating at 2000 volts), we find the proper plate current of the bottom of the chart to be 200 ma. Now following the 2000-volt dotted line on the voltage chart until it intersects the 200 ma. line, the desired plate input is found to be 400 watts. The current can be varied by adjustment of the load to secure this optimum condition. (Reprinted with permission from the *Thordarson Transmitter Guide*.)

DB	POWER RATIO
1	1.25
2	1.6
3	2.0
4	2.5
5	3.17
6	4.0
7	5.0
8	6.33
9	8.0
10	10.0
11	12.5
12	16
13	20
14	25
15	32
16	40
17	50
18	64
19	80
20	100
24	250
27	500
30	1000
40	10,000
50	100,000
60	1,000,000

DECIBEL CONVERSION TABLE

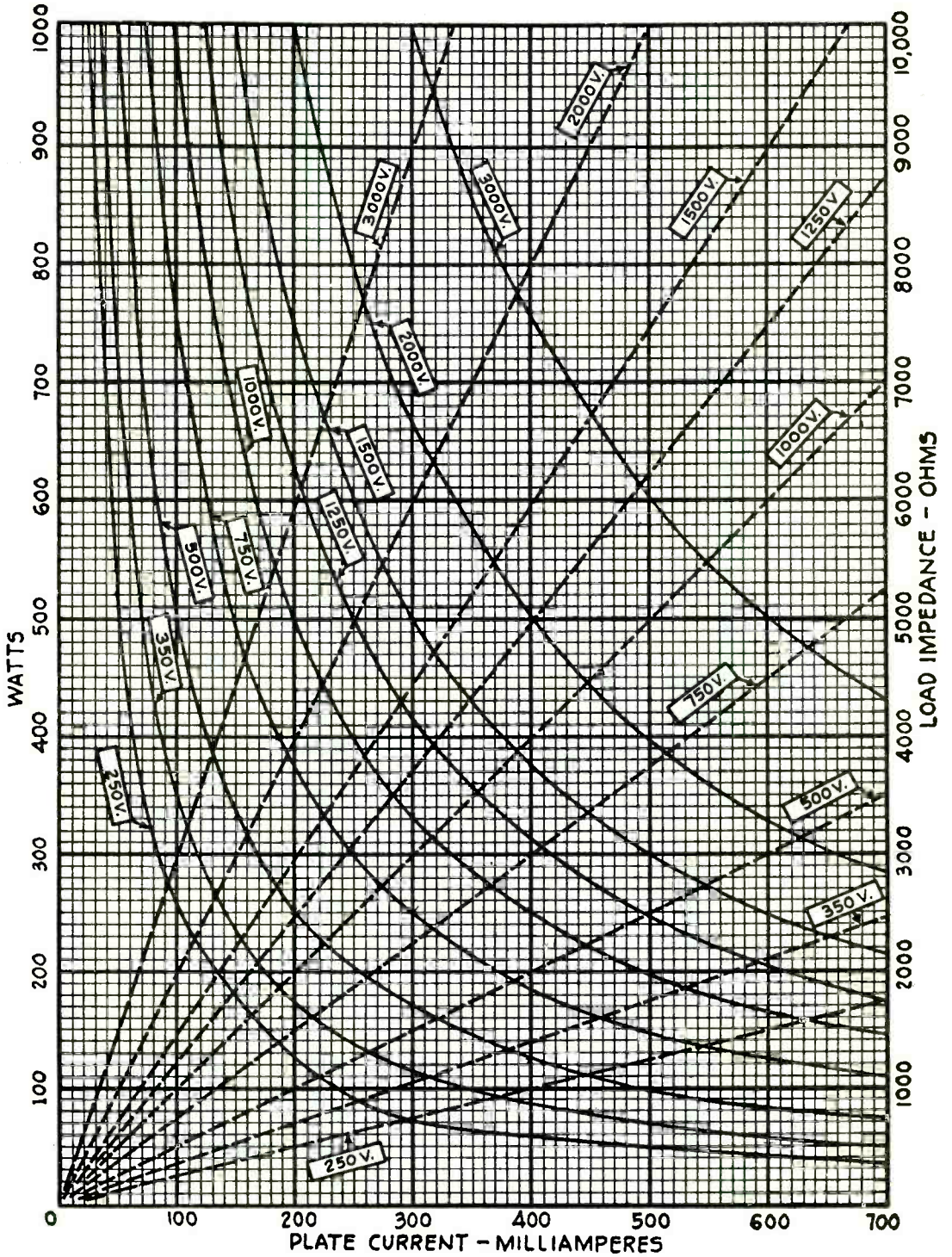



Effective B.C.L. QRM Reduction

By F. C. EVERETT*

The relations of the phone man with neighboring b.c.l.'s are none too cordial, particularly on the

160 and 75 meter phone bands. The phone transmitter has a greater capability for interference and is more easily traced. It cannot be cured by the application of a simple filter to the transmitter; each affected receiver must be treated in a different manner.

The situation is naturally aggravated by widespread use of "cigar box" receivers which are obtainable for \$10 or so. But even the more expensive receivers are not all immune, usually because of some oversight of the designer. Some of these reasons are: no preselection (to produce a cheaper receiver), overload of tubes with accompanying cross talk, insufficient oscillator shielding in superheterodynes, etc.

The interference can be grouped roughly into two classes from the start. The first class is that encountered with a tuned r.f. receiver in all of its various forms (particularly the cheap receiver) and receivers having an overloaded tuned r.f. stage. The usual symptoms are spreading of the signal over the high frequency end of the dial on the broadcast receiver.

The obvious answer is more tuning ahead of the receiver, which means a wave trap of some sort. The thing that pops into almost everyone's head when a wavetrap is mentioned is the circuit shown in figure 1: a tuned circuit in parallel resonance, which is tuned to the interfering signal and offers a high impedance in the antenna circuit to the interfering signal. This is satisfactory in some cases and does tend to reduce interference of the type mentioned, but there is another form requiring no more apparatus which is of more value.

This circuit is shown in figure 2 and consists of a series-tuned circuit connected across antenna and ground of the receiver. This acts as a short circuit (approximately) across the antenna and ground at the frequency to which it is tuned. This is of advantage since the first coils in the receiver and associated leads may

One cure for squawks from b.c.l.'s on your radiophone interference is to kill off all the complaining b.c.l.'s (somewhat impracticable). Another is to stay off the air with your transmitter. But the best thing to do is to study this article and go about the problem the right way. The b.c.l.'s won't know when you are on the air.

have sufficient pickup in a strong field to pick up a signal without the antenna connected.

A quick check can be made on all receivers to see whether or not additional tuning will be effective by shorting the antenna and ground connections to the troubled receiver. If the interference still persists, the trouble probably cannot be eliminated by any form of preselection and further investigation will have to be made.

The second class of interference encountered is that which troubles superheterodynes. It occurs when there is not sufficient preselection ahead of the first detector, or when the oscillator circuit is not well enough shielded and isolated (allowing some signal to get into it). The symptoms are repeat points at various spots on the dial, from one to a dozen or more, where the interfering amateur (or police) station can be heard. The amateur usually "repeats" right on the irate b.c.l.'s favorite station, or at least so it usually seems.

The situation is aggravated and complicated by the fact that the oscillator has harmonics and the transmitter has harmonics and the receiver has image response. This can easily lead to a large number of repeat points.

This is the logical place for the insertion of the low pass filter, figure 3. This will wipe out the harmonics or at least reduce them, since it has an attenuation curve as shown in figure 4. The wavetrap will not prove satisfactory in cases of this type since the harmonics of the transmitter and of the receiver oscillator will not be eliminated.

There is one trouble with the low pass filter, and that is the way in which the attenuation curve makes its leisurely way toward cutting off the interference. On 160 meters, particularly, if the low pass filter is designed to eliminate the signal well, the high frequency end of the broadcast band will be rather weak on the b.c.l. receiver, and while this may be tolerated in some cases, it is not the best solution in the world.

*209 Frazer St., Findlay, Ohio.

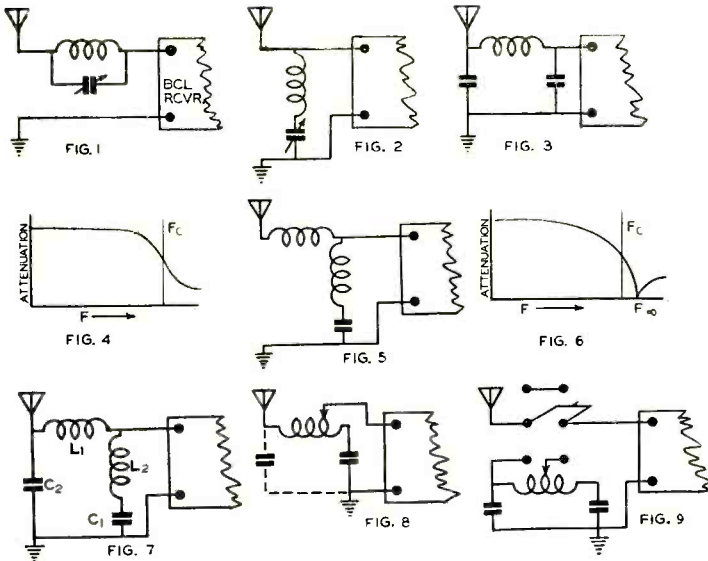

The answer is the use of the "M derived" type of low pass filter, or sharp cut off filter. The circuit is shown in figure 5. This has a cut off characteristic as shown in figure 6. This filter is more effective in use and just as cheap to construct, as will be shown later.

In cases where the harmonics are strong, the circuit of figure 5 may not be entirely effective and the circuit of figure 7 can be employed by merely adding one condenser. This will more effectively attenuate the higher frequency harmonics since it is a combination of low pass filter and a sharp cut-off low pass filter. Also note that L_2 C_1 tune to the transmitter frequency, giving the same action as the circuit in figure 2. This makes figure 7 the best type of tuning unit for all types of interference.

This may look like rather a complicated circuit, but a cheap form can be made easily from inexpensive components. To make this plainer the circuits of figure 5 and 7 are shown redrawn in figure 8. The coils of L_1 and L_2 have been combined into one coil with a tap or a variable tap. C_2 , if used, can be about 250 μ fd. and C_1 a compression type mica condenser, thus doing away entirely with expensive air condensers. However, by using a coil with a slider, fixed mica condensers can be used in both applications and the cost may be kept very low by using for L_1 and L_2 one of the so called "antenna eliminators" which is nothing but a coil with a slider on it. They can be obtained from mail order houses and five and ten cent stores. By the use of two 250 μ fd. condensers

and one of these coils it is possible to build these units in a compact form; the case can be taken off the unit and the wiring changes made and the two condensers mounted inside. There is then just one adjustment, the slider, and once adjusted it need not be touched, since changes of frequency within the same band with the transmitter usually require no change in adjustment of the gadget. The cost is low (under fifty cents per unit) and the outfit is small and can be hidden inside the receiver cabinet and forgotten.

Just one disadvantage is presented by these units. The reception on short waves will

be impaired by their use. Therefore, if the owner insists on short wave reception he must either be shown how to disconnect it, or a switch arranged to do so when desired. A small double pole, double throw switch is suitable for this disconnection and a circuit is shown in figure 9.

To carry on to some other troubles, particularly when shorting the antenna and ground will not eliminate the interference: If there is a coil mounted beneath the chassis—particularly the oscillator coil—with no other shielding, and the receiver is in a strong field, the antenna tuning may be futile or a tuned r.f. stage on the receiver itself may do no good. The reason is that many chassis pans are built without bottoms and the solution is to supply one. Galvanized iron sheets (roofing) are cheapest and can be cut to size and slipped under the chassis and usually will produce the desired effect, although it may be necessary to realign the oscillator circuit due to the tuning effect of the additional shielding in close proximity to the coil.

Another thing that should not be overlooked, especially if the amateur has a surprisingly large number of complaints, is re-radiation and shock excitation. This used to be a common form in the old spark days, but seems to have been forgotten lately.

It is possible for guy wires and lighting and telephone circuits to become tuned to or near the transmitting frequency and re-radiate, even several blocks from the transmitter. Sometimes this makes itself evidenced by readily ob-

servable effects, such as lighting electric bulbs in houses when the switch is turned off, talking in the telephone, and many other phenomena which are individual and freakish. These can be cured by detuning or grounding the circuit by means of a mica condenser. If the field is intense and the transmitter powerful enough, sometimes a hunt with a neon bulb will show r.f. in surprising places. If exploring a lighting or other high voltage circuit an insulating fixed condenser should be used in series with the neon bulb.

It also might be well to use a line filter on the transmitter. This, in its simplest form, is a couple of fairly large condensers (.01 μ f. or larger) connected in series across the line with the midpoint grounded. Mica condensers will usually be more effective than larger paper ones and in some cases chokes will be needed, in addition, to afford better isolation. These should be wound of rather large wire, depending upon the load, usually no. 12 or 14 wire being sufficient except for high power.

In some cases a line filter will be effective on the receiver. This is true in cases when the second detector seems to be originating the trouble. The line is feeding it right into the heart of the set and the line should be filtered.

This all presumes that the transmitter is properly adjusted. Of course if the modulation capability of the transmitter is being exceeded, hash and spurious transmissions will result which are impossible to filter out, since actual b.c.l. frequencies are being transmitted. Frequency modulation will also produce similar trouble!

But the prize packages are the class B linear amplifiers without a swamping resistor in their grid circuits. Due to a dynatron dip in some grid circuits, they are liable actually to radiate spurious signal on their half frequency or any other frequency without rhyme or reason. The cure, of course, is a grid swamping resistor.



The winner of the Podunk QLF endurance CQ contest.

A Novel Two-Band Antenna

There are many non-class-A hams who are restricted in their phone activities to the 10 and 160 meter bands. In a large number of cases, limited back-yard room dictates that only one antenna can be used. Since the antenna requirements of these two bands are ordinarily

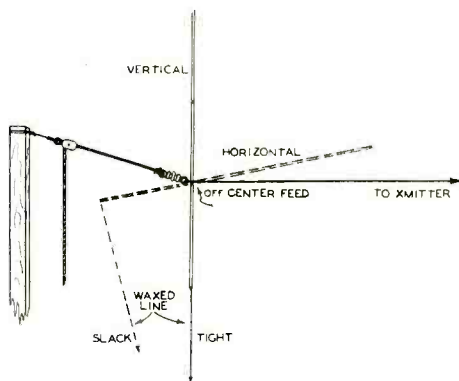

Showing the 10 meter radiator and how it is swung into various positions for different polarization and angles of radiation. Both rod and single wire feeder are worked against ground as a Marconi on 160 meters.

quite different, a simple antenna that would work effectively on both bands would certainly be in order.

The figure shown indicates a convenient arrangement for this purpose, requiring only one pole and a minimum of other equipment. It consists of a piece of $\frac{1}{2}$ or $\frac{3}{4}$ inch aluminum or dural (preferably dural, although it is more difficult to obtain) rod or tubing about 16 feet long, with a long single-wire feeder cut so that the feeder plus rod resonates as a Marconi on 160 meters. The rod is tapped 14% or about 2' 3" from the center. At this point the single-wire feeder is connected and the rod is wired to the antenna insulator. Then, to the short end of the rod is connected a long piece of waxed fish line that reaches to the ground. The large size of lacing twine available from many electrical supply houses is also excellent for this use.

The feed line itself can be any convenient length from about 110 to 150 feet. Actually, the best length is from $\frac{1}{4}$ to $\frac{3}{8}$ wavelength at the 160 meter frequency used ($\frac{5}{16}$ has been found optimum by experiment). This wire can be strung out from the pole to the house or garage and then to the shack, just so its total length is the required value. Since 160 is only reliable for short-haul contacts, top efficiency



is not required and this arrangement will give as good results as any Marconi of the same average height. This wire can be tuned by the conventional series condenser and pick-up coil arrangement, either against a ground or a counterpoise.

On 10 meters however, we want the best antenna operation possible. The rod should be high above ground, in the clear, and should have a minimum of guys, well-broken-up. With our halyard pulled taut and the waxed cord tight, we have an efficient "low-angle" 10 meter vertical radiator well away from surrounding interfering objects. In addition, if desired, we can obtain horizontal or any other orientation of polarization by slacking the guy-cord until the rod tilts at the desired angle.

For 10 meter operation, the end of the feed line can be coupled through a .002 μ f. mica condenser to the final tank. If push-pull final is used, however, it is usually best to use one of the well-known methods of coupling a single-wire line to a push-pull tank.

Mu vs. Actual Audio Gain

The static value of μ is given in all standard tube characteristic charts. The actual voltage gain of a tube in an audio amplifier is less than the theoretical μ because part of the gain is always lost across the plate load resistance. In the Cunningham-Radiotron Manual, Series RC-12, a formula appears on page 10 by which the actual voltage gain of a tube may be calculated.

This is: Actual voltage amplification equals $\mu \times \text{Plate Load}$

Plate Load + Plate Resistance

The table following gives the theoretical gain in db for several values of μ and also the db gain for actual voltage amplification as derived from the above formula. Thus for a tube with an actual voltage amplification which is less than the rated μ , the column headed "Audio Decibel Gain" may be used.

Voltage Gain or μ	Equivalent Db Gain	Audio Db Gain	Voltage Gain or μ	Equivalent Db Gain	Audio Db Gain
1	0	0	12.5	21.9	15.9
2	6	5	15	23.5	17.5
3	9.4	8	20	26	20
4	12	10	25	28	21.9
5	14	11.5	100	40	33.9
6	15.6	12.5	200	46	35
7	16.9	13.5	500	54	37.5
8	18.1	14	1000	60	40
9	19	14.4	1500	63.5	42
10	20	14.8			

If one will think in terms of db rather than in μ or voltage gain, he will find that it is much easier to make calculations. The overall db gain of an amplifier is the sum of the db gain figures for each tube. Any coupling device between tubes merely transfers but does not increase power, hence there is no db gain except that secured by the tubes. If you are in favor of doing your own mathematics, figure the actual voltage amplification of each tube, find the logarithm of that figure in a log table having a base of 10, and multiply the logarithm by 20 to obtain the exact db gain.

A practical method of using this information may be applied to an amplifier. You may wish to know the probable amplification in db of an amplifier. Suppose this amplifier had a 57 tube working into a 56 through a resistance coupling, and that tube coupled through a 1 to 2 ratio transformer to a 2A5. Then with the tube chart on pages 22 and 23, which gives the db gain of each type of tube in an audio amplifier, add the db gain of a 57 to a 56 to a 2A5, thus 42 + 16 + 35, or 93 db. Of course, if the amplifier works some of its tubes at a lower gain level by reducing the voltage or using low plate resistance for the sake of stability or hum elimination, and consequently does not carry a db rating as high as figures indicate might be possible, that is no reflection upon the amplifier. In calculating the gain of push-pull or parallel tubes, assume the μ of one of the tubes and from the above chart or the tube chart, use the audio decibel gain for that value of μ . The mathematical analysis of this appears in the formula for actual voltage amplification—with parallel tubes, the net plate resistance is one-half that of a single tube, but in good design, the plate load is made one-half also, hence the gain remains the same as for a single tube. The same reasoning holds true for push-pull tubes where the plate-to-plate impedance is twice that of a single tube. (See tube manufacturers' recommendations for push-pull plate impedance.) —Table courtesy *Thordarson Transmitter Guide*.

Someone objected to the crack last month to the effect that "160 meters is a good place to get rid of jokes that are not funny in print or in the theater any more." All right, we have no objection to your getting rid of them on 75 meters if you want to, or even 20 meters for that matter. In fact, you don't have to get rid of them at all. Come to think of it, the latter is probably the best idea anyway.



High Voltage Cheap

By CHARLES FELSTEAD*

The power supply for a large radio transmitter is usually the most expensive portion of the transmitting equipment. The most satisfactory form of high-voltage supply is that provided by a well-filtered motor-generator set; but one of those outfits is so costly that most radio transmitter owners employ instead some type of rectifier in

Nearly all old timers are familiar with the use of "pole pigs" as plate supply transformers, and have at some time or other used one in their rig. However, many newcomers are not familiar with this inexpensive means of obtaining plate volts. For the benefit of those who are considering medium or high power we show the different types and methods of connections of the more common pole transformers.

220 and 110 volts for house lighting purposes may be employed as a plate transformer.

These pole transformers are mounted in oil-filled iron cases, and may be observed near the tops of electric poles wherever 220-volt house lines connect with the main 2200-volt feeders.

Pole transformers of this type that have been replaced by newer models, or that have been found to be no longer satisfactory for power work, can usually be purchased quite cheaply from the electric light companies in most parts

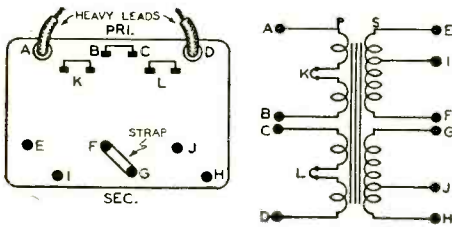

Figure 1

Tapped type of 220:2200-volt transformer, 250- or 500-watt size. Voltage ratio 1:10. With 110 volts across AB or CD; or with 220 volts across AD and B connected to C:

EF = GH = 1100 volts
IF = GJ = 990 volts
EI = JH = 110 volts

With F connected to G:

EH = 2200 volts
EJ = IH = 2090 volts
IJ = 1980 volts

With 110 volts across AD and B connected to C:

EF = GH = 550 volts
IF = GJ = 495 volts
EI = JH = 55 volts

With F connected to G:

EH = 1100 volts
EJ = IH = 1045 volts
IJ = 990 volts

With 110 volts across AL or KD and B connected to C:

EF = GH = 825 volts
IF = GJ = 742½ volts
EI = JH = 82½ volts

With F connected to G:

EH = 1650 volts
EJ = IH = 1567½ volts
IJ = 1485 volts

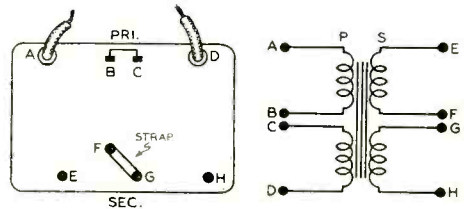

Figure 2

Untapped type of 220:2200-volt transformer, 250- or 500-watt size. Voltage ratio 1:10. With 110 volts across AB or CD; or with 220 volts across AD and B connected to C:

EF = GH = 1100 volts

With F connected to G:

EH = 2200 volts

With 110 volts across AD and B connected to C:

EF = GH = 550 volts

With F connected to G:

EH = 1100 volts

of the country. These transformers, even though not suitable for the power company's purposes, are usually excellent for supplying the plate voltage for a radio transmitter, as the current required for radio work is very small in comparison with the current carried by the transformer in electric power transmission.

The electric companies customarily sell these discarded pole transformers for the junk price of the iron and copper in them (sometimes, unfortunately, requiring the junk dealer to cut the windings). Occasionally, a transformer will be encountered that cannot be used as a plate transformer; but if the transformer is carefully examined before purchase and appears to be satisfactory, there is small possibility that it will be worthless.

The transformers are sold mounted in heavy

conjunction with a high-voltage transformer and a suitable filter. In such installations, it is the transformer, which must supply two or three thousand volts at several hundred milliamperes to a rectifier, that is the item of greatest cost.

In the absence of a suitable radio transformer, a regular pole transformer of the type employed by electric companies to reduce the 2200-volt supply brought in by the main power lines to

*W6CU, 1148 Stearns Drive, Los Angeles, Calif.

iron cases that are equipped with detachable covers; but the oil with which the cases are filled when in service is not included. This is just as well because the oil is not necessary when the transformer is used for radio work. The most common sizes are the quarter-kilowatt (250-watt) and half-kilowatt (500-watt) transformers, which sell for about \$3.75 and \$5.00, respectively; but these prices vary with the price of junk metals. These two sizes of transformers have primaries wound for 2200 volts, and 220-volt secondaries.

There are also two types of one-kilowatt transformers that may occasionally be purchased. One has a 6600-volt primary and a 220-volt secondary, and the other has a 6600-volt primary and a 550-volt secondary. These larger transformers are ideal for use with high-power transmitters; because even with full-wave rectification it is possible to have a 3000-volt output from the filter, allowing for more than normal voltage drop in the rectifier and filter.

The transformers are used with their primaries and secondaries reversed. This means that the 220-volt winding (which is the secondary in power work) is connected to the 110-volt or 220-volt alternating-current power line; and the 2200-volt winding (the primary in power work) is employed as the source of the high voltage for the rectifier.

If the 220-volt winding is connected to a 220-volt source, the output of the transformer

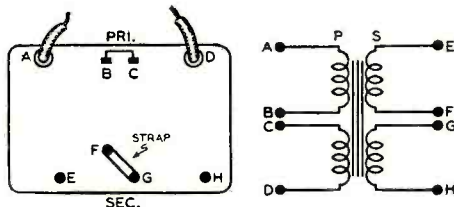

Figure 3

Untapped type of 220:6600-volt transformer, usually 1000-watt rating. Voltage ratio: 1:30
 With 110 volts across AB or CD; or with 220 volts across AD and B connected to C:
 EF = GH = 3300 volts
 With F connected to G:
 EH = 6600 volts
 With 110 volts across AD and B connected to C:
 EF = GH = 1650 volts
 With F connected to G:
 EH = 3300 volts

will be 2200 volts; but if the 220-volt winding is connected to a 110-volt source, the output of the transformer will be only 1100 volts. The case just considered was for a 220:2200-volt transformer, which could be of either 250- or 500-watt rating.

The two sizes of 220:2200-volt transformers may be purchased in tapped and untapped types. With the untapped models, the only output voltages that may be obtained are 550, 1100, and 2200 volts, unless a variable auto-transformer or rheostat is used in the primary circuit. In the accompanying tables of voltages that may be obtained with the various transformers, no means of regulation of voltage (other than of tapping the transformer windings) is taken into consideration. The 220:6600-volt and 550:6600-volt transformers likewise are constructed in models with tapped and untapped windings; but only one example of each model is shown in the tables of voltages.

Both the primaries and secondaries of the several types of transformers are divided into two sections, as may be seen in the accompanying diagrams. The primaries are indicated by the letter P and the secondaries by S. These are not the real primaries and secondaries as used in power work, but are the windings as they should be employed for radio transmission. The lettering of the terminals of the transformer windings usually corresponds with the lettering in the accompanying tables.

The most common type of tapped 250- or 500-watt transformer is illustrated in figure 1. With the two primaries of this transformer in series and the two secondaries in series, and 220 volts a.c. across the primary windings, the combined secondaries will deliver 2200 volts. It will be seen that there is a wire strap brought out in the center of each primary winding that can be tapped onto for obtaining intermediate voltages. These straps are marked K and L in the drawing. When less than the two full primary windings in series is employed, it is not

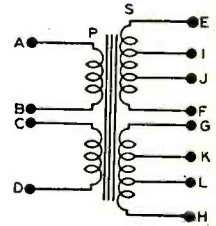

Figure 4

Tapped type of 550:6600-volt transformer, usually 1000-watt rating
 With 275 volts across AB or CD; or with 550 volts across AD and B connected to C:
 EF = GH = 3300 v.
 EJ = IF = GL = KH = 2200 v.
 EI = IJ = JF = LH = 1100 v.
 GK = KL = 550 v.
 With F connected to G:
 EH = 6600 v.
 EL = IH = 5500 v.
 EK = IL = JH = 4400 v.
 IK = JL = 3300 v.
 JK = 2200 v.
 With 275 volts across AD and B connected to C:
 EF = GH = 1650 v.
 EJ = IF = GL = KH = 1100 v.
 EI = IJ = JF = 550 v.
 GK = KL = 550 v.
 With F connected to G:
 EH = 3300 v.
 EL = IH = 2750 v.
 EK = IL = JH = 2200 v.
 IK = JL = 1650 v.
 JK = 1100 v.
 The voltages that could be secured with 110 or 220 volts across the primaries are not listed because they could easily be computed from the table given above.

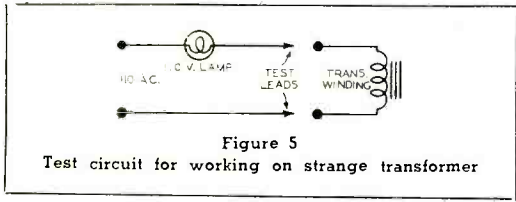

Figure 5

Test circuit for working on strange transformer

safe to use more than 110 volts across the primary. There is also a connection brought out on each secondary winding toward the outer end, marked *I* and *J*. The table is so arranged that it will show the various voltages obtained with different combinations of primary and secondary taps.

In figure 2 is depicted the connection of the coils in the untapped equivalent of the transformer represented in figure 1. The untapped type of 220:6600-volt transformer is illustrated in figure 3; and the tapped type of 550:6600-volt transformer is shown in figure 4. The various combinations of voltages obtainable with these transformers are given in the tables accompanying the illustrations. The wattage rating of the transformer has no effect upon the voltage output, of course, but only upon the amount of current that may be safely handled by the transformer at the voltage employed. The wattage ratings of these pole transformers are usually very conservative.

Care must be observed in connecting up a new transformer; for while the terminals on the top may be arranged like those in the accompanying illustrations, the actual connection of the coils *may* be entirely different from that shown. The safe procedure with a new transformer is to "feel out" the connections with a test circuit such as shown in figure 5.

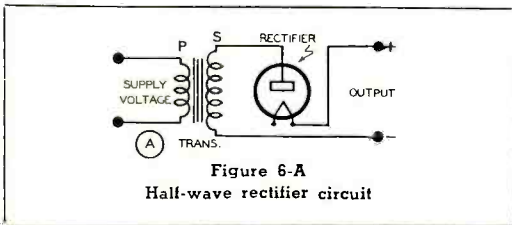

Figure 6-A

Half-wave rectifier circuit

The larger the transformer winding interposed between the test terminals, the higher the resistance, and the less brightly the test lamp will light. Naturally, the lamp will not light on an open circuit; and on a short circuit, it will light to full brilliance. This test circuit is a substitute arrangement; an ohmmeter would be more satisfactory. Comparisons between pri-

mary and secondary windings cannot be made.

If only a single primary winding is required with the primary voltage available, it is desirable to connect the other primary winding in parallel with it. This will permit twice as much current to be drawn safely by the primary; and if there is a heavy load on the transformer, it will operate cooler.

When the windings are connected in parallel, they should be carefully tried out with the test circuit before the transformer is used; for if they are connected so that the two halves of the winding "buck", it will be equivalent to a short circuit on the power line. Bucking windings will be indicated by the test lamp lighting to full brilliancy. If the windings buck, the trouble can be corrected by reversing the leads to one of the coils. The secondary coils may be paralleled in the same way.

The manner in which the windings are connected and the voltage applied to the primary of a transformer depends, in any particular case, on the voltage required by the radio transmitter and whether half- or full-wave rectification

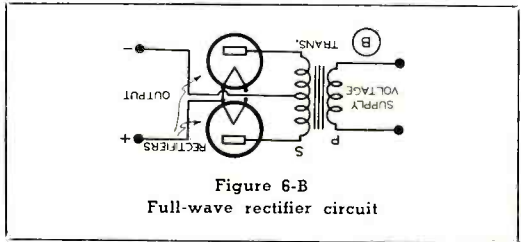

Figure 6-B

Full-wave rectifier circuit

is employed. It is immaterial whether a synchronous, chemical, mercury-arc, or vacuum-tube rectifier is used.

If 1100 volts is applied to the half-wave rectifier shown in figure 6A, the output of the rectifier will be 1100 volts minus the voltage drop through the rectifier tube. But if 1100 volts is supplied to the two rectifier tubes of the full-wave rectifier in figure 6B, the output voltage will be only half that much, or 550 volts minus the drop through the tubes. When a full-wave rectifier is employed, the transformer must be so connected that a tap is available at the electrical center of the secondary winding. These facts must be carried in mind when deciding on the manner in which the coils of a transformer are to be connected.



The Mayor calls it the "twenty meter foam band" because the phone hams get themselves worked up into such a lather over the terrific QRM.



Modern Transmitter Design

By J. N. A. HAWKINS, W6AAR

In general, amateur transmitter design consists in turning the junk box upside down in the middle of the floor and then using what is available. Few of us ever get a chance to lay out a transmitter with every detail just as we would want it, without regard to cost. However, all of us, at one time or another, mentally design our ideal transmitter.

We all have definite opinions on just what type of crystal-controlled exciter we would choose. We all have some pet tube type for the final amplifier and we also sometimes dream about a particular mechanical layout, perhaps built into bay after bay of beautifully finished relay racks, or perhaps even a long table covered with separate breadboards for each stage. While 95% of us can never fully realize our fond dreams, it still is useful mentally to argue with ourselves as to the relative merits of this or that arrangement or circuit feature. Only by thoroughly considering the advantages and disadvantages of every detail of a transmitter can we approach a really good transmitter.

Design is a matter of compromise. Good engineering is largely a matter of compromising result with cost. As no two amateurs are after exactly the same combination of performance, convenience, consistency, appearance, and overall efficiency, there naturally can be no one transmitter that will represent everyone's ideal. It is rather rare for a transmitter description that many amateurs will want to copy exactly to appear in a magazine. Everyone has some ideas for improvement which will make any particular transmitter somewhat more desirable in his eyes. It is these "improvements" which cause so much lost sleep among magazine editors in trying to answer inquiries about why a published rig does not operate as claimed when it was copied "exactly" (except for putting a 210 in place of something else, using 50 μfd . instead of the 100 μfd . that might have been specified, using shunt feed and grid neutralization instead of, etc., etc., etc.). Quite often changes in published circuits and mechanical layouts do represent improvements, but it should be emphasized that small changes in electrical and mechanical layout can have a vastly more far reaching effect throughout the transmitter than many people evidently real-

ize. An expert can "make changes" and visualize most of the effects on the rig before it is built. A novice usually sees only the advantages of the new feature, without adding in the disadvantages to the overall compromise.

The problem of making improvements in standard transmitters is somewhat analogous to the troubles experienced in "hotting up" a model "T" Ford for higher speeds. We would start with a bigger carburetor, manifolds, valves, and a trick head to raise the compression. Then we would start burning up bearings and even breaking crankshafts. The next step was to buy oversize connecting rods and a balanced crankshaft. Next the transmission bands and bearings gave up the ghost and we probably went for an oversize clutch and bearing arrangement in the transmission. Then the universal joint became sloppy and was replaced by something oversize. Personally, I was cured when I gradually strengthened everything from the engine back to the rear axle, only to shear off the rivets on the ring gear half way up a very steep hill, which left me nothing but the hand brake to keep me from rolling backward. Those familiar with the average model "T" hand brake will know what happened next. As I had to rebuild the car anyway after the episode, I sold my high-powered motor and went back to strictly stock motor and most of my troubles ended.

We find that the same holds for radio transmitters. We make one small change in a published rig, then we have to make another to offset the first change, then another to offset the second change, and so on. We finally end up with an entirely different transmitter.

The purpose of this article is to outline briefly a step-by-step layout of a transmitter, discussing the pros and cons of the compromises faced at each step. For purpose of example we will discuss a simple kilowatt c.w. transmitter.

A Simple 1 Kw. C.W. Transmitter

We first must decide just what we want this transmitter to do. I am going to limit it to a quick-change 2-band transmitter, although a third band can be used by adding plug-in coils and a second crystal. We will limit it to 80, 40, and 20, as 10 meters does not justify a kilowatt at the present time. We will assume that this rig is to be built by an apartment

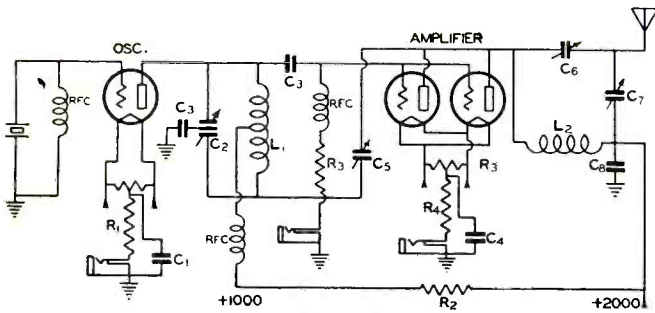

Figure 1

Wiring diagram of the transmitter described in the text

R ₁ —500 ohms, 15 watts	C ₁ —.01 μfd.	C ₅ —10 μfd., 4000 v. spacing
R ₂ —10,000 ohms, 200 watts	C ₂ —50 μfd. per section, 2000 volt spacing	C ₆ —100 μfd., 4000 v. spacing
R ₃ —2500 ohms, 25 watts	C ₃ —.001 μfd., 5000 v. mica	C ₇ —200 μfd., 1000 v. spacing
R ₄ —250 ohms, 200 watts	C ₄ —.01 μfd., 1000 v. mica	C ₈ —.002 μfd. mica, 5000 v.

dweller and that it must be extremely compact. Cost, as usual, is an important item. Incidentally, I feel that not enough attention is being paid to the element of cost, in most transmitters. Before any intelligent discussion of transmitter merits can be made, *accurate* cost estimates should be drawn up. With the aid of a little practice and a mail order catalog you can soon learn to estimate costs with very little error. The cost of this transmitter is under \$125 without the plate transformer and without labor. The plate transformer was omitted from this estimate because plate transformer costs vary so widely. This rig uses a 1 or 1.5 KVA transformer with a 4400 volt center-tapped secondary to give about 2000 volts rectified and filtered direct current at about 575 milliamperes. A suitable pole transformer is currently worth less than \$5.00 when and if available, but will not be quite as satisfactory as a transformer specifically designed for this service.

The Actual Design

Now, for obvious reasons, we will start with the antenna and work backward toward the crystal oscillator. This may seem illogical to those who usually start with an exciter and then work forward, but it is important to realize that the antenna and the final amplifier contribute all of the signal, while the exciter and driver stages should be considered merely as accessories associated with the final amplifier.

The antenna problem can be solved in any number of ways. There is no ideal antenna. However, I am going to choose the single-wire-fed Everitt for this arrangement as it can be

made to hit 80, 40, and 20 meters with little difficulty and has less radiation from the feed line than a zepp. system. As this rig was assumed to be used in an apartment house the neighbors should appreciate any efforts made to reduce feeder radiation. A multiband antenna of some sort is usually essential for apartment house use as separate antennas for each band fed with untuned two-wire lines usually take up too much room, although they represent the ideal system at the present time.

Now that we have decided upon an antenna we can proceed to plan the layout of the final amplifier. A single-wire-fed antenna works with least complication from a single-ended final amplifier. A push-pull amplifier usually necessitates a separate antenna tank, which means another high-powered tuned circuit and a complex readjustment of tube loading when changing frequency. The single-ended amplifier also is cheaper to build, as less attention to circuit symmetry is necessary and only one neutralizing condenser need be used. Using the single-ended amplifier also allows us to use one of the various versions of the simplified π network, which materially simplifies tuning up the rig. The circuit of one of the simplest and best line-to-plate coupling arrangements is shown in the circuit diagram of figure 1. This happens to be my simplification of the Jones simplification of the Collins simplification of the Western Electric version of the π network. This particular arrangement has the advantage over the Jones circuit (see figure 2) in that series feed is used, which eliminates an r.f. choke. It has the advantage over other series feed modifications of the Jones circuit (see figure 3) in that there is no d.c. present across the high capacity coupling condenser C₇ of figure 1. There is also no d.c. on the feeder, which is essential in apartment house installations where Willie's kite and sister's lingerie both get hung on the feeder at one time or another. The only bad feature to this circuit shown in figure 1 is that the rotor of C₆ is hot with r.f. and an insulated shaft coupling must be used to eliminate hand capacity when tuning. This is a minor matter and can be easily arranged.

Note that the use of any of the simplified π networks requires that the final amplifier be

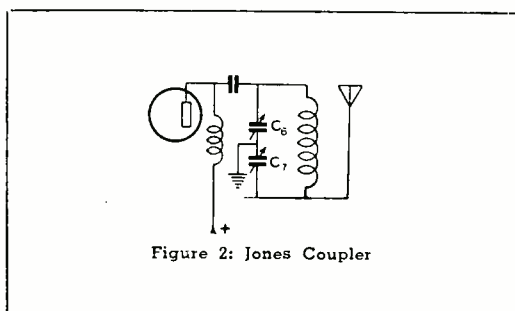

Figure 2: Jones Coupler

grid neutralized. This is no particular disadvantage as the argument between grid and plate neutralization is very close to a 50-50 break. With plate neutralization the plate tank condenser (which in this case corresponds to C_6 and C_7 in series) needs to have only a quarter the capacitance of the plate tank condenser in a grid-neutralized stage, for the same circuit Q or merit. However, it has to have twice the plate spacing, as the peak r.f. tank voltage will be twice as high in the grid neutralized arrangement. Thus the tank condenser costs will be about the same, whichever neutralizing scheme is used. The grid neutralizing scheme has a slight advantage in that it is less subject to degeneration effects which rob many plate-neutralized amplifiers of much of their grid-to-plate power gain.

While it is true that a single ended amplifier feeds more even harmonics to the antenna than does a push-pull amplifier, the use of the capacitive-coupled π section network shown filters out most of the harmonics before they reach the feeder and those that do finally reach the feeder are quite weak compared to the fundamental. Also, as this is a c.w. rig, the even harmonics can be made to fall within other ham bands so that QSL's from the F.C.C. will not result from the weak harmonics that do reach the antenna.

We will make a virtue out of the ability of a single-ended class C amplifier to generate even harmonics and use the final amplifier as a doubler on 20 meters. This expedient is in disfavor with many amateurs, although they are usually not sure just why there is anything wrong with it. Often, when doubling in the final amplifier, a considerable amount of fundamental power is radiated causing signals on two bands at once.

This is undesirable as it causes unnecessary interference, but the line-to-plate coupler shown discriminates strongly against the fundamental when tuned to the harmonic and does it much

better than most conventional antenna coupling arrangements in this respect. Of course, the power output and plate efficiency fall off when doubling in the final, but the added cost and complication of a doubler stage in the transmitter is not justified, as the resulting increase in signal on 20 meters is materially less than one half point on the R scale. Aside from the question of cost of a doubler stage, is the fact that by doubling in the final, all that is necessary to go from 40 to 20 meters is to retune the final amplifier, as the tuning condensers hit both bands with the tank coil used. Changing is a matter of not more than 5 seconds.

Now that we have more or less decided to use a single-ended grid-neutralized final amplifier, comes the question of choosing a tube or tubes for the final amplifier. Choosing a tube for the final amplifier necessitates choosing a plate power supply at the same time. There is always one combination of tube rating, plate voltage, filter condensers, and tank condensers that is most economical for a given power classification. For a c.w. rig we can run more class C plate current on the final amplifier than the more conservative tube manufacturers recommend for continuous operation, or for phone use. Personally, after blowing up almost every known make of tube, starting with the H tubes and VT2's of 17 years ago, I have formulated a rule of thumb about rating the maximum d.c. plate current desirable for any transmitting tube. With a thoriated tungsten filament tube, I multiply the filament voltage by the filament current to get the filament heating power, in watts. Then I allow a maximum of 5 milliamperes of space current for each watt of filament heating power. Thus with a tube such as a 211, with a 10 volt 3.25 ampere filament, I find that the 32.5 watts of filament heating power, at 5 milliamperes per watt, justifies a d.c. plate current of 162.5 milliamperes, and no more, as far as I am concerned. I have found examples of exceptionally good tubes of various types that gave good life at a higher plate current than given by this rule of thumb, but the exceptions were rare enough to satisfy me that the rule is worth following. While this rule gives a value of d.c. plate current that is, in some cases, lower than that recommended by the particular tube manufacturer, I follow the rule anyway as rating standards vary considerably.

From many standpoints, one ideal plate voltage is 1500 volts. This would allow the use of the new Pyranol and Dykanol 2000 volt filter

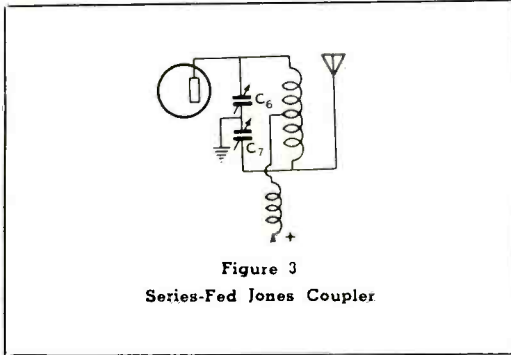

Figure 3
Series-Fed Jones Coupler

condensers which are so cheap in the 4 $\mu\text{fd.}$ size. However, for one kilowatt input we would have to use tubes in the final amplifier that could handle 666 milliamperes of plate current. By the emission rule this would require a tube or tubes with one-fifth of 666, or 133 watts of filament heating power. This would mean four tubes of the 32.5 watt filament power class, such as the 805 or the 852. 852's are quite hard to drive to good plate efficiency at 1500 volts and four 805's would cost over \$70. Also while parallel operation is all right, within limits, the use of four tubes in parallel on high frequencies would almost undoubtedly give trouble from parasitic oscillation. Even three tubes in parallel are generally undesirable, if not from parasitics then from high grid to ground and plate to ground capacitance, which would make it difficult to get efficient grid and plate tank circuits.

Thus the answer to this problem is to go to a higher d.c. plate voltage for the final amplifier. How high should we go? Let us go back to the question of tube filament heating power to get an answer. Looking at a tube table we find the prices of transmitting tubes take a big jump right above the 354-150T classification. These two types have 5 volt 10 ampere filaments and thus utilize 50 watts of heating power. The rule of 5 milliamperes per watt indicates that either of these tubes is good for 250 ma. of space current, class C. If we used *one* of these tubes, a d.c. plate voltage of 4000 volts would be required. If we used two such tubes in parallel we could get a kilowatt input with a 2000 volt plate supply. Let us consider the pros and cons of a one kilowatt, 2000 volt, 500 milliamperes supply versus a 4000 volt, 250 ma. supply. For a given degree of ripple filtering the filter costs should, theoretically, be exactly the same for both supplies. This point is not generally appreciated by the majority of

amateurs. They point out that a 4000 volt, one $\mu\text{fd.}$ filter condenser costs about four times as much as a one $\mu\text{fd.}$, 2000 volt condenser of the same quality. Quite true, but the one $\mu\text{fd.}$, 4000 volt condenser has four times the energy storage and filtering effectiveness as the one $\mu\text{fd.}$, 2000 volt condenser. For the same filtering effectiveness at 4000 volts as a one $\mu\text{fd.}$ condenser working at 2000 volts, we only need *one-quarter* of a microfarad, and the costs of these two condensers should be the same. In exactly the same way the filter choke problem works out so that almost exactly the same amount of copper and iron is necessary in filter chokes for 4000 volts at 250 ma. or 2000 volts at 500 ma. For a given degree of filtering of the 4000 volt, 250 ma. supply let us assume that a 20 henry, 250 ma. choke is required. As filtering effectiveness of a choke varies as the square of the current through the choke, for the same degree of filtering the 2000 volt supply would use a 5 henry,

QSL CARD CONTEST

To the owner of what our judges vote the most clever or distinctive QSL card, RADIO will give as first prize one Amperex HF-100, and one RK-39 will be given as second prize.

The card may be a line-cut cartoon, a photographic card, a regular printed card, or any other type. However, color will not be taken into consideration. In other words, if your card is printed in fancy colors, it will have no more chance of winning than a plain black-and-white card. Only one entry may be sent in by one person.

To enter, take one of your cards and write on the *back* any suggestions you have for the improvement of the magazine. What you write will have no bearing on the chances of your card winning the contest (the judges will examine only the front), but you must offer some constructive criticism in order to qualify. *Do not write anything on the face of the card.* Enclose the card in an envelope and mail to RADIO, c/o Contest Editor, 7460 Beverly Blvd., Los Angeles, Calif. Enclosing the card in an envelope will keep it from becoming soiled in the mail. This is necessary, as the eight best cards will be reproduced in RADIO for the benefit of our readers. These will include the two winners and the next six runners-up.

Contest closes February 28, 1937. Entries must be postmarked by that date. Entries are not limited to this country; they may be from any foreign country. Foreign winners must pay import duty on their prizes.



500 ma. choke in place of the 20 henry, 250 ma. choke used in the 4000 volt supply. For a given quality of construction, a 20 henry, 250 ma. choke would cost about the same as a 5 henry, 500 ma. choke, assuming that they were made in the same quantities. This same point holds for both filter condensers and plate transformers. Thus while theoretically there should be no difference in cost between a 2000 volt supply and a 4000 volt supply, both to give 1 kw. output, the 2000 volt supply is actually slightly cheaper because its components are made in larger quantities.

Rectifier Tubes

However, before definitely deciding upon a 2000 volt plate supply we must consider the question of rectifier tubes. The 2000 volt plate supply will have a 500 ma. load from the final amplifier and in addition we may want to use it for part or all of the exciter in order to reduce the number of plate supplies in the rig. Thus the load is almost certain to be more than 500 milliamperes. 500 ma. is the maximum rating for full-wave 866's working into a *good* input choke. Well. I have had very good life from 866's working at 600 ma. (choke input) and 866's are cheap; so if we can keep the exciter drain down below 100 ma. on the 2000 volt supply we *can* get by with 866's.

Of course, we could go to 2500 volts plate voltage and thus cut down the current drain but we then make the peak a.c. ripple voltage rise above 3000 volts, and the next filter condenser classification is 4000 volts, where filter condensers start to get really expensive. So, if possible, we want to use not more than 2200 volts of plate voltage so that we can squeeze by with 3000 volt filter condensers.

Thus let us go ahead, for the time being, with a 2000 to 2200 volt plate supply for the final and see what we can do with the rest of the rig.

We now have a final amplifier that will run at about 2000 volts and 500 milliamperes. We can use two HF200's, T155's, a pair of 354's, or two 150T's. The latter two types have heavier filaments to justify the extra cost. There is little to choose between the 354 and the 150T. The filament emission works out just right for 500 ma. operation of the pair. They both have a μ of about 13, so there is no choice on that point. They both are easily driven and will require about 25 watts of drive for cool operation at a kilowatt input at 2000 volts. If more drive is available it will increase the output and effi-

ciency, particularly when doubling in the final to 20 meters. For running a cool kilowatt input when doubling, about 50 watts of grid drive will be required; so if possible we should try to get a good 50 watts of 40 meter output from our exciter.

The Exciter

There is an endless number of good exciters that we could use to get our minimum of 25 watts and our maximum of 50 watts of drive for the final amplifier. We could use a long string of little tubes and make them grunt or we could use a few big tubes and let them loaf. Personal preference enters into all exciter discussions. However, the whole exciter question has been more or less upset recently by the W6UF exciter using a 35T as a 50 watt crystal oscillator. The 6L6 push-pull oscillator described last month also fills the bill nicely.

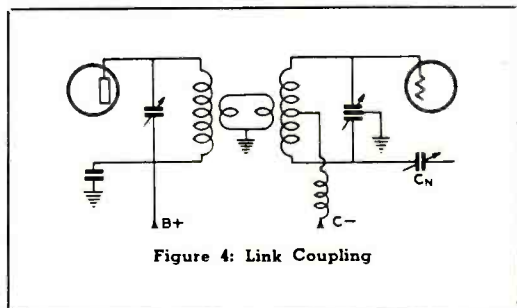

Figure 4: Link Coupling

Interstage Coupling

One of the busiest arguments in the transmitter field concerns the question of interstage coupling. There are as many interstage couplers as there are antenna couplers and each has its supporters. They are practically all capable of giving about the same results when properly built and adjusted; so while one system may be simpler or more convenient to adjust, there can be no question of one being more *efficient* than another.

Link coupling, shown in figure 4, seems to have every advantage in its favor except simplicity. It is easy to adjust, it is not critical to build, and it allows series feed of both driver and driven stages. However, it is complicated, expensive, and takes up room. Link coupling is merely a special type of inductive coupling; so we might look into the simpler types of inductive coupling as a better answer to this particular problem. The most common type of inductive coupling is shown in figure 5 and uses a tuned plate, untuned grid circuit. This circuit works quite well, when properly built and ad-



justed. However, the tuned grid arrangement shown in figure 6 is preferable. The main advantage of the circuit of figure 6 over that of figure 5 is that the tuning condenser works in a circuit with lower d.c., and possibly r.f. voltages, present. Thus a cheaper tuning condenser is satisfactory. Another advantage is that neutralizing troubles can occur in the arrangement of figure 5 that are absent in the arrangement of figure 6.

Straight inductive coupling is nearly ideal for a manufacturer of commercial transmitters that cover a wide range in operating frequency. However, the coils are not easy to construct as the coil design is almost entirely a matter of cut and try. The number of secondary turns of the coil shown in figure 6 is determined by the tuning and stray circuit capacitance in the usual way. However the number of primary turns and the amount of coupling between primary and secondary can be found only by means of a great deal of cut and try. Thus for a commercial builder of transmitters, who makes many copies of a given coil structure that all will work in identical transmitters, a few hours or days spent in trying out various and sundry coil arrangements becomes a small item. However, for the average ham who has not the measuring instruments to determine accurately which coil combination gives the proper exciting voltage on the driven stage, inductive coupling is not recommended. However, I mention these points for those who might possibly be interested in making such an arrangement work.

One point about inductive coupling which should be brought out is that you can tune *either* the plate or the grid winding but don't try to tune both windings. Due to the close

coupling between windings, double tuning will only lead to overcoupling and a double humped tuning curve. Interlock will usually be so bad that you won't be able to find *true* resonance in either circuit.

Capacitive Coupling

Therefore, while I think that inductive coupling has an advantage in that series feed can be used, which eliminates r.f. chokes and high-voltage grid-blocking condensers, at least at points of high r.f. potential, I feel that the advantages of simplicity and convenience inherent in a capacitive coupling arrangement make its use desirable in this particular transmitter.

Thus in figure 1 will be seen a straightforward capacitive coupling arrangement which uses a split tank circuit in order to allow grid neutralization of the final amplifier.

This arrangement uses a split stator tuning condenser, which has its rotor grounded to r.f. but which is not grounded to d.c. While the normal operating plate voltage of the oscillator does not exceed about 1250 volts d.c., when keying or testing surges often run the d.c. voltage up to 2500 volts or so which would let a grounded rotor arc over, which is hard on chokes and dropping resistors. Thus a .001 μ d. mica blocking condenser is used between the condenser rotor and ground to prevent these arc overs. Note that there is relatively little d.c. across the neutralizing condenser C₂ due to the fact that both sides of that condenser connect to high voltage d.c. points. The d.c. voltage difference approximates 750 volts so that if an r.f. peak should cause the neutralizing condenser to flash over, d.c. will not maintain the arc.

R. M. A. COLOR CODE

For Fixed Condensers, Unit: Micro-Microfarads

For Resistors, Unit: Ohms

First Dot	Second Dot	Third Dot	Body Color	End Color	Dot Color
Black 0	Black 0		Black 0	Black 0	
Brown 1	Brown 1	Brown 0	Brown 1	Brown 1	Brown 0
Red 2	Red 2	Red 00	Red 2	Red 2	Red 00
Orange 3	Orange 3	Orange 000	Orange 3	Orange 3	Orange 000
Yellow 4	Yellow 4	Yellow 0000	Yellow 4	Yellow 4	Yellow 0000
Green 5	Green 5	Green 00000	Green 5	Green 5	Green 00000
Blue 6	Blue 6	Blue 000000	Blue 6	Blue 6	Blue 000000
Purple 7	Purple 7	Purple 0000000	Purple 7	Purple 7	Purple 0000000
Gray 8	Gray 8	Gray 00000000	Gray 8	Gray 8	Gray 00000000
White 9	White 9	White 000000000	White 9	White 9	White 000000000

Keying the Transmitter

Full breakin is practically a necessity in this day and age and any transmitter without it is out of date. The simple and logical keying arrangement for this rig is primary keying. We could key in the cathode of the oscillator, but that would necessitate external bias or all cathode bias for the final, as well as a husky bleeder on the plate supply to protect the filter condensers against keying surges and to minimize keying thumps. Then again a keying relay to handle 2000 volts is both rare and expensive. The plate voltage is not 2000 volts, due

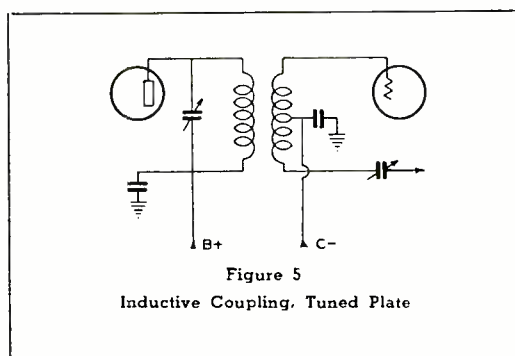

Figure 5
Inductive Coupling, Tuned Plate

to the plate dropping resistor, but when the cathode or B minus return to the oscillator is open (key up) the voltage becomes 2000 volts, without allowing for a rise in power supply voltage when the load is removed.

While this oscillator has somewhat less tendency to chirp when keyed than many other oscillators, it still can be made to chirp unless the plate tuning is carefully adjusted. It was found that less chirp occurred with primary keying than with center tap keying. With primary keying the oscillator plate voltage changed from zero to between 1000 and 1250 volts after the key was closed. With center tap keying the plate voltage started at about 2500 volts then dropped down to the normal operating value between 1000 and 1200 volts. In the primary keying case, the oscillator probably did not start to oscillate until the plate voltage neared its normal value. In the case where the oscillator was keyed in the center tap, it probably started immediately the key was closed, thus giving rise to the chirp while the plate voltage was falling from 2500 down to 1250 or thereabouts.

Grid Bias

We have no choice in the bias source for the crystal oscillator stage. That comes from a 500

ohm cathode bias resistor. That method has been found to be the real answer for the 35T crystal oscillator. Using grid leak or any other bias source for the oscillator merely raises the r.f. crystal current and lowers the output.

Bias for the final amplifier can be supplied from almost any source. There is little point in adding a separate power supply to the transmitter just to supply bias for the final amplifier; so some form of self-resistor bias is the logical and simple answer.

Grid leak bias, where the negative voltage is supplied by rectified r.f. grid excitation, has the advantage that it causes no loss of plate voltage, is self adjusting in that it regulates itself with the grid excitation, and is cheap. It has the disadvantage that there is no negative bias on the final amplifier tubes without grid excitation. Thus when the crystal stops oscillating the final gets very warm if only grid leak bias is used.

Cathode bias has the advantage that it adjusts itself to changes in plate current, high plate current giving high negative bias. It tends to hold down the amplifier in the absence of grid drive, but has the disadvantage that it causes a loss in plate voltage on the tube in an amount equal to the bias.

Thus good design necessitates a compromise between the good and bad features of both types of bias supplies.

This compromise is pretty well satisfied by the combination of 250 ohms of cathode bias in addition to 2500 ohms of grid leak bias.

Note that as the two stages each use cathode bias, they cannot be fed filament voltage from the same transformer winding. Two separate 5 volt filament transformers must be provided, one supplying about 5.3 volts at 20 amperes and the other about 5.15 volts at 4 amperes. These margins over the required 5 volts of filament voltage are necessary to make up for the drop through average length filament leads from transformer to socket. There must never be less than rated filament voltage *at the socket*.

Miscellaneous Comments

Jacks are shown in figure 1 at convenient metering points. If high voltage jacks are used, a wooden plug or an unused plug can be used to open the B negative to the amplifier at the amplifier cathode jack. This enables the final to be neutralized easily. The average phone jack will arc over at 2000 volts d.c. However, there are a few of the older type jacks which seem to stand the 2000 volts without arcing over.

Concerning rectifier tubes, some makes of



150T CHART OF AMPLIFIER PERFORMANCE

D.c. Plate Voltage	D.c. Plate Current	D.c. Power Input	Power Output	Plate Loss	Plate Efficiency	Angle of Plate Current Flow	D.c. Grid Bias	D.c. Grid Current	A.c. Grid Voltage	Grid Driving Power	Power Gain	Peak Space Current	Minimum Plate Voltage
E_{op}	I_{op}	P_{in}	P_{out}	P_{Loss}	Eff_p	θ	E_c	I_{ug}	E_s	P_{ex}	H_{gp}	I_s	E_{min}
1500V	.285A	428W	294W	134W	68.5%	180°	-120V	.015A	370V	5W	59	1.090A	250V
1650	.285	470	330	140	70	180	-132	.015	382	5.15	64	1.09	250
1750	.285	500	352	148	70.4	180	-140	.015	390	5.26	66.6	1.09	250
2000	.285	570	420	150	73.5	180	-160	.015	410	5.44	77	1.09	250
1500	.367	550	361	189	66	180	-120	.03	420	11.3	31	1.44	300
2000	.367	734	501	233	68	180	-160	.03	460	13.4	37	1.44	300
2000	.265	530	401	129	76	130	-328	.03	628	16.9	23.7	1.44	300
2500	.265	662	519	143	78.2	130	-368	.03	668	18	28.6	1.44	300
3300	.265	875	710	165	81.5	130	-433	.03	733	20	36.5	1.44	300
2000	.199	400	319	81	79.5	110	-587	.04	827	29.5	10.8	1.44	300
2500	.199	500	412.5	87.5	82.5	110	-627	.04	927	33.3	12.4	1.44	300
3300	.199	660	562	98	85	110	-691	.04	991	34.6	16.2	1.44	300

866's are materially better than others. A little experience will enable you to recognize the characteristic color which is present in the glow of a good mercury vapor rectifier. The glow should nearly fill up the envelope in an unshielded tube, although the cathode shield in the 866A types confines most of the ionization to the space within the anode. The difference in color between a good rectifier and one not so good is difficult to describe. Perhaps the best way to describe the difference is to say that the color looks either "healthy" or "unhealthy". If you get a chance to look at one of the newer Western Electric rectifiers in action you will get some idea of the color of the "healthy" glow.

Incidentally, while on the subject of rectifiers, keep your eyes open for second-hand Western Electric 258B's. These husky rectifiers are widely used in broadcast, police, and airport transmitters and have a 2.5 volt, 7 ampere oxide filament. They run very nicely at space currents up to 1000 milliamperes for a full-wave pair, and the peak current rating is close to 1.2 amperes. The maximum inverse peak voltage for these tubes is between 5000 and 7500 volts. I wish some of the makers of cheap 866's would look into this matter of the 258B rectifier tube.

They are well worth copying. They have a special 2 pin base so that the tube can be periodically reversed in its socket to equalize wear and tear on the filament. This point alone adds about 50% to the life of a 2.5 volt rectifier filament and nearly doubles the life of a 5 volt rectifier filament. These benefits apply only to mercury vapor rectifiers.

Computing Tube Performance

For those who want to carry the details of transmitter design out to more detailed and accurate results, I wish to commend a rather new method of calculating class C amplifier performance on paper. This method was described by Terman and Roake, of Stanford University, in the Institute of Radio Engineers proceedings for April, 1936. Several approximate methods of calculating class C amplifier performance have been developed in the last few years, but none as simple and as accurate as the one developed under the direction of Dr. Terman. The analysis can also be extended to frequency multipliers. While there is no point in presenting the details of the calculation method at this time, our readers might be interested in the accompanying chart of performance developed by computation and checked experimentally. The only

point about the method which might be improved on is the question of d.c. grid current. In all the computations of Terman, the d.c. grid current is assumed to be approximately 20% of the average d.c. plate current. This assumption is correct for many cases but gives values for grid driving power that are too high when using tubes which are easy to excite. The values of power gain and grid driving power shown in the chart were obtained experimentally.

The chart shows three types of amplifier operation: class B operation for maximum power gain, extreme class C operation for maximum plate efficiency, and an intermediate condition wherein these two factors have been compromised.

The data are divided up into four groups, marked A, B, C, and D. Data A and B deal with class B operation, where the amplifier bias was made equal to cut-off. Data C deals with a condition intermediate between class B and extreme class C where the angle of flow was 130 degrees. Data D deals with the extreme class C condition where the angle of flow was 110 degrees and the bias ranged from about 3.6 times cut-off at 2000 volts, to about 2.6 times cut-off at 3300 volts plate voltage. Thus, while I term the conditions shown in data D as extreme class C, it can be seen that it is really not extreme at all compared to some amateur tube operation where the bias reaches as much as 5 times cut-off.

The operation is defined by the column headed "Angle of plate current flow". An angle of 180 degrees equals one half cycle, which is the class B condition, and the negative bias is equal to cut-off. The effect in raising the plate voltage is quite marked, as the power gain through the stage goes up to the high value of 77 at 2000 volts plate voltage (data A). The four sets of data included opposite "A" were obtained by limiting the instantaneous peak space current to 1090 milliamperes. The maximum positive grid voltage was made equal to the minimum plate voltage, 250 volts. At this point the plate current is 900 ma. and the grid current is 190 ma. The data given opposite B, C, and D used 1.44 amperes as the maximum allowable instantaneous space current. This value of space current flowed when the maximum positive grid voltage equaled the minimum plate voltage and they both equaled 300 volts. At this point the plate current was 1200 ma. and the grid current 240 ma.

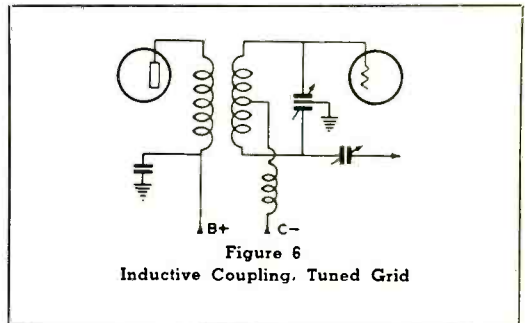

The data opposite B was not considered useful, as the plate loss figures came out somewhat above the ratings on the tube. It is interesting to note that the 199 ma. of d.c. plate current drawn opposite data D was just as hard on the filament emission as the 367 ma. of d.c. plate current drawn under the data opposite B. This shows how class C operation of a tube can be much harder on a tube filament than class B operation at a much higher level of average d.c. plate current. The data opposite D also is interesting in that it shows that the peak space current can reach over 7 times the average d.c. plate current indicated on the plate milliammeter. The data opposite D was taken for an angle of plate current flow of 110 degrees, which is not too extreme. Many amateur stations are operating with shorter plate current pulses, thus indicating that the peak currents in those stations are undoubtedly somewhat higher than 7 times the average d.c. plate current.

Note how fast the power gain through the amplifier stage goes down as the bias and plate efficiency are raised.

The results show that surprisingly high plate efficiencies can be obtained even when the amplifier is biased only to cut-off. This matter of ultra-high grid bias can be greatly overdone.

The error factor was found to be not more than about 5% and the computations err on the conservative side, where any error appears.

The 150T was chosen for this study because it is one of the few tubes on the market with complete curves available in the positive grid region. The constant current curves supplied by the maker were found to be quite accurate and easy to use. We wish more of the tube manufacturers would take the trouble to make up complete and accurate curves of tube performance in the positive grid region. Curves in the negative region are practically meaningless

[Continued on Page 148]



A New and Complete Tube Table

At least once a year we find it necessary to compile a rather complete reference of the new transmitter tubes which have appeared. This is necessary for our own use in designing transmitters and thus we present it in the hope that it may prove as useful to the reader as it is to the staff of RADIO. This tube table differs from those we, and others, have presented before in that the various tubes are divided up into groups and each group is followed by a brief discussion of the group as a whole. This last year has seen close to 50 new transmitting tubes made available to the amateur. They are coming thick and fast and it will be seen that a great deal of duplication has resulted where different manufacturers have brought out practically the same thing under a different type number. While standardization is undoubtedly generally desirable from the economic standpoint, in the transmitting tube field there was no real progress in either improving the product or lowering the cost until the old standard types began to be replaced by the new and different products of the independent manufacturers. The principal improvements have been in using superior anode materials, first carbon and more recently tantalum. Also the increase in the amount of filament emission compared to the plate loss rating shows that high efficiency operation is being encouraged. This tendency will be evident from studying the columns in the tables showing filament heating watts and rated plate loss watts. Formerly the plate loss rating was from about three to six times the filament heating power. Now it is steadily declining and, in

one case, the plate loss rating is only about 1.4 times the filament heating power. There is no substitute for high filament emission in a transmitting tube. The emphasis used to be placed upon how much power the tube would dissipate on its plate. Now the emphasis is more properly placed upon how much power the tube can put out, which is the real function. Tubes are no longer *dissipaters* but are *power converters* which convert d.c. into high frequency a.c. with a high degree of conversion efficiency.

The newer tubes lay particular stress upon low inter-element capacitance to reduce the circulating radio frequency current flowing through the tube seals at high frequencies. Also the seals themselves are being enlarged and improved. It is not generally known that the high frequency resistance at a tungsten-Nonex seal can be as high as 150 ohms. As the current at the higher frequencies can easily reach several amperes, it will be seen that the seals can introduce quite a material loss of r.f. energy. Some manufacturers are using two or three seals connected in parallel to reduce this seal resistance. Stranded leads are also a prolific source of r.f. resistance at frequencies above 10 megacycles and are being avoided in many of the newer tubes. As it is almost impossible to tie solidly a top cap to a grid or plate lead that is not stranded, most of the tubes that use solid leads come without "grid caps" on element connections, as no simple means has been devised to fasten the cap to the tungsten lead.

Table A

With the exception of the last four tubes shown on the list, all in this table are either receiving tubes or are modifications of receiving tubes. Thus they will not stand, in general, high plate voltages. A few, such as the RK-23, 25, 34; the 802; and the 807 carry plate voltage ratings of around 500 volts and can be operated (at the lower frequencies) at as high as 600 to 650 volts, provided the space current and plate and screen losses are kept down. The RK39 is rated at 750 volts. However, for the balance of the tubes 250 to 350 volts is about all they will stand. At 350 volts few of the receiving tubes will give anything like normal life, but their replacement cost is usually so low that short life is not uneconomical.

Where the metal tube types are to be used for transmitting, it is believed that the "G" or octal-glass

types are preferable, at the present time, to the straight metal types.

One of the most interesting of the new tubes included in the above list is the 807. This tube is a slightly modified 6L6. It uses a standard 5 pin base and the plate lead is brought out the top of the envelope. The plate lead is shielded from the control grid to allow the tube to operate without neutralization and the envelope is glass. Tests with this tube at 500 volts show that it gives considerably more output at 30 Mc. than will the 802 type of pentode at the same voltage. It also seems somewhat more rugged than the 802 type. The RK39 is the Raytheon counterpart of the 807. The RK39 carries a higher plate voltage rating, but has higher grid-plate capacity, making neutralization usually necessary.

Table A

TUBE TYPE	CATHODE			PLATE LOSS	μ	INTERELECTRODE CAPACITANCES			Base	COMMENTS
	Volts	Amps	Watts			Cgp	Cgf	Cpf		
45	2.5	1.5	3.75	10N	3.5	8	5	3	M4	TRIODE
46	2.5	1.75	4.4	10N	30				M5	TETRODE
47	2.5	1.75	4.4	10N	150	1.25	8.7	13.2	M5	PENTODE
42	6.3	0.7H	4.4	10N	220				M6	PENTODE
6F6	6.3	0.7H	4.4	10	200				O7	PENTODE
RK15	2.5	1.75	4.4	10	30	7.5	2.7	5	M4C	DOUBLE GRID TRIODE
59	2.5	2.0H	5	10N	30				M7	PENTODE
RK16	2.5	2.0H	5	10	6	7.5	3.8	6	M5	DOUBLE GRID TRIODE
RK17	2.5	2.0H	5	10	220	1	7.5	16	M5G	PENTODE
53	2.5	2.0H	5	10N	35				M7	DUAL TRIODE
6A6	6.3	0.8H	5	10N	35				M7	DUAL TRIODE
RK34	6.3	0.8H	5	10N	35	2.7	4.2	2.1	M7AA	DUAL TRIODE (UHF)
6N7	6.3	0.8H	5	10	35				O8	DUAL TRIODE
RK23	2.5	2.0H	5	12N	...	02	10	10	M7A	SHIELDED PENTODE
RK25	6.3	0.8H	5	12N	...	02	10	10	M7A	SHIELDED PENTODE
802	6.3	0.8H	5	15N	...				M7A	SHIELDED PENTODE
WE307A	5.5	1.0	5.5	15N55	15	12	M5A	PENTODE
2A3	2.5	2.5	6.3	15N	4.2	13	9	4	M4	TRIODE
6A3	6.3	0.9	5.7	15N	4.2	13	9	4	M4	TRIODE
6A4	6.3	0.9	5.7	15	4.2				O6	TRIODE
6L6	6.3	0.9H	5.7	21	...				O7	BEAM TETRODE
807	6.3	0.9H	5.7	21	...	0.2	11.6	5.6	M5A	BEAM TETRODE (SHIELDED)
RK39	6.3	0.9	5.7	20	...	1	12	7.5	M5A	BEAM TETRODE
WE300A	5.0	1.2	6.0	40N	...	15	9	4.3	M4	TRIODE
250	7.5	1.25	9.4	25N	3.8	9	5	3	M4	TRIODE
WE211D	10.0	3.	30	65N	12				J4	TRIODE
WE211E	10.0	3.	30	65N	12				J4	TRIODE
WE248A	10.0	3.	30	65N	12				J4	TRIODE
WE212D	14.0	6.0	34	200N	16	19	19	2	Spec.	TRIODE



The Tube Tables

The classification of all transmitting tubes, and those receiving tubes widely used in transmitters, is in six separate tables. The tubes are classified first in order of filament heating power, and then in order of rated plate loss. This method is highly desirable as the power output capabilities of any tube are more closely related to the filament heating power than to any other single characteristic. Of course, an ideal tube table would give the tubes in order of r.f. power output, but so many different factors enter into a rating of power output that such a table would be impossible to compile. Such a table could only be accurate at one given set of conditions for each tube.

No operating constants are given. Such a table would represent a compromise of many conflicting factors and we feel certain that it is much more desirable to enable each tube to be

operated under an optimum set of conditions to fit the particular case involved. It is not a difficult task to describe a simple experimental procedure which will allow the operator to fit his variable factors, such as negative bias and antenna coupling to the more or less fixed limits of plate current, plate loss, plate voltage, and grid drive that he actually has to face in his particular rig. An article in the last issue covers the adjustment of a class C amplifier in the detail which the subject requires.

Abbreviations

In all the following tables it is necessary to utilize abbreviations in order to conserve space. The first column in each table gives the tube type designation. The tubes without a prefix are, in most cases, those made by RCA. The *suffix* T after the type number identifies the EIMAC tubes; while the *prefix* T indicates TAYLOR. The prefix HK stands for Heintz

Table B

TUBE TYPE	CATHODE			PLATE LOSS	μ	INTERELECTRODE CAPACITANCES			Base	COMMENTS
	Volts	Amps	Watts			Cgp	Cgf	Cpf		
12A	5	25	1.25	5N	8.5	8.5	4	2	M4	TRIODE
71A	5	25	1.25	7N	3	7.5	3.2	2.9	M4	TRIODE
WE316A	2	3.65	7.3	30M	6.5	1.6	1.2	0.8	Spec.	TRIODE (U.H.F.)
841	7.5	1.25	9.4	15N	30	8	5	3	M4	TRIODE
842	7.5	1.25	9.4	15N	3	7	4	3	M4	TRIODE
10	7.5	1.25	9.4	15N	8	8	5	4	M4	TRIODE
801	7.5	1.25	9.4	20C	8	6	4.5	1.5	M4	TRIODE
865	7.5	2.0	15	15M05	10	7.5	M4A	TETRODE
T756	7.5	2.0	15	40C	25	8	3.5	2.7	M4	TRIODE
T825	7.5	2.0	15	40C	8	7	3	2.7	M4	TRIODE
T55	7.5	2.0	15	55C	20	2.5	1	0.7	M4A	TRIODE (U.H.F.)

Table B shows the smallest tubes using thoriated tungsten filaments. Only those tubes with 15 watts or less of filament heating power are shown.

New types include the WE316A tube for ultra-high frequency use up to 500 megacycles. This tube is an overgrown acorn tube and has been nicknamed everything from "The Mud Turtle" to the "Muffin", due to its strange shape. It operates well at 1 1/4 meters.

The T55 is a tube of low C construction that is of recent design.

The T825 somewhat resembles the old Sylvania 830 and should not be thought of as similar to the Sylvania 825.

The T55 should be compared with tubes at the top of table "C" instead of with other tubes in table "B", as it more closely resembles them in performance.



and Kaufman, Ltd., makers of GAMMATRONS. The prefix WE stands for WESTERN ELECTRIC. F stands for the Federal Telegraph Co. HF stands for AMPEREX; the prefix C stands for COLLINS. The prefix RK needs little introduction as the symbol for RAYTHEON.

The second column gives the filament or heater voltage in volts; the third column gives

the filament or heater current in amperes. If the cathode heating current is followed by the letter H it indicates that the tube uses an indirectly heated cathode, such as the 53 or 6L6.

The fourth column shows the filament heating power, in watts, and is a new addition to a tube table. Note that table A deals exclusively with the oxide coated type of filament tubes, ranging from the 45 to the WE212D. Tables

Table C

TUBE TYPE	CATHODE			PLATE LOSS	μ	INTERELECTRODE CAPACITANCES			Base	COMMENTS
	Volts	Amps	Watts			Cgp	Cgf	Cpf		
35T	5	4.0	20	35T	30	2	1	0.5	M4A	TRIODE (U.H.F.)
830	10	2.0	20	40C	8	9.9	4.9	2.2	M4	TRIODE
830B	10	2.0	20	50C	30	10	6	2	M4A	TRIODE
T841A	10	2.0	20	50C	14.6	9	3.5	2.5	M4A	TRIODE
HF100	10	2.0	20	75C	23	4.5	3.5	1.4	M4AD	TRIODE (U.H.F.)
RK20	7.5	3.0	22.5	40N012	11	10	M4A	PENTODE
RK31	7.5	3.0	22.5	40	27				M4	TRIODE
WE254B	7.5	3.25	24.4	25M085	11.2	5.4	M4A	TETRODE
800	7.5	3.25	24.4	35N	15	2.5	2.75	1	M4AC	TRIODE (U.H.F.)
RK30	7.5	3.25	24.4	35	14	2.5	2.75	2.75	M4AC	TRIODE (U.H.F.)
RK32	7.5	3.25	24.4	50	14	3	2	1	M4AC	TRIODE (U.H.F.)
RK35	7.5	3.25	24.4	35T	30	2.7	3.5	4	M4AD	TRIODE (U.H.F.)
RK37	7.5	3.25	24.4	35T	45	2.7	3.5	4	M4AD	TRIODE (U.H.F.)
834	7.5	3.25	24.4	50C	11	2.5	2.2	0.6	M4AC	TRIODE (U.H.F.)
WE304B	7.5	3.25	24.4	50N	11	2.5	2	0.7	M4AC	TRIODE (U.H.F.)

Table C shows those tubes with more than 15 and less than 25 watts of filament heating power.

At least seven of the tubes shown in this group are new to any tube table.

The HK55 is a new gridless Gammatron triode designed mainly for use as a self-excited oscillator.

The 35T needs little introduction as it has been termed the most copied tube of the year. This tube strikes a new low for interelectrode capacitance in its class. It has about the lowest plate loss rating of the group, but the manufacturers state that the intermittent plate loss may reach 200% of normal without damage to the tube.

The HF100 has about the highest plate loss rating of the group, so should be the most desirable for

use as a linear or bias modulated amplifier.

The 800 is being succeeded by the 834 and similar tubes for ultra-high frequency use.

The RK31 is designed for zero bias class B audio use and is the only one in the group.

The RK35 and RK37 are quite similar except for amplification factor. The T841A should not be interchanged with the 841 as the characteristics differ materially. The T841A closely resembles the 830B except for the amplification factor.

The 830 is now obsolete but can generally be replaced with the T825 shown in table B, if the filament voltage is changed. Normal class C plate current for the tubes in this group will be from about 100 to 150 milliamperes.



B to F inclusive deal with the thoriated tungsten type of tube filament except for those few tubes which use a pure tungsten filament and which are identified by an asterisk in place of the heating power. (See the HK255, F108A, and F100A.) With the exception of the tungsten filament tubes, all the tubes in tables B to F have a power conversion capability which is closely proportional to the filament heating power. Other things being equal, the most useful tube will be the one with the most filament heating power. This generally needs some qualification, but it is far more accurate than any other single basis for comparison. This presentation of filament heating power also allows a check on the degree of conservatism of the maximum space current ratings laid down by the manufacturer. At one time, the vast majority of tubes were rated on the basis laid down years ago by the Western Electric Co. Those ratings provided a common yardstick and every amateur knew that he could multiply those values of maximum space current by about 2 without flattening out his tube. Now, however, relatively few manufacturers make any attempt to stick to that old rating standard, as those who do suffer in comparison with the rating methods employed by the optimists in the tube business. It is now practically a case where every new tube of a given classification appears with at least 10 more milliamperes of average maximum space current rating than the last one. In an attempt to provide a common yardstick it will be found that the filament heating power is the only useful basis for establishing a standard of maximum safe space current, which is the sum of the average d.c. grid current plus the average d.c. plate current.

Oxide Filament Ratings

To find maximum safe average space current in milliamperes, multiply the heating power, in watts, by 10 for continuous service, and by 15 for intermittent or keyed service. Take the 6L6, for example. The table shows that the cathode draws 0.9 amps at 6.3 volts, or 5.7 watts. Thus when 5.7 is multiplied by the factor 10 we get 57 milliamperes as the safe maximum space current for continuous service. For intermittent, or keyed service, we use a multiplying factor of 15, which gives us a maximum of about 85 milliamperes total safe space current. Note that this just applies to oxide-coated filaments of modern design. The older types such as the 211-D, etc., are not capable of this high performance.

Pure Tungsten Filaments

Pure tungsten filaments are rare, as the more modern thoriated tungsten type of filament is considerably more efficient. A tungsten filament tube can be run at all the d.c. space current it can be made to draw. The filament cannot be damaged by space current overload but for phone use where linearity is a factor the average unmodulated d.c. space current, in milliamperes, will be about one milliampere for each watt of heating power. Thus, for example, the F-108A can be driven up to perhaps 350 ma. of space current for c.w. use, although its 110 watts of filament heating power allow only about 110 ma. of space current for satisfactory and linear plate modulation. It will also be found that it is difficult to obtain high plate efficiency with a tungsten filament tube. They can be made to draw lots of plate input, if driven hard enough, but the output just goes up so far and then stops regardless of the input. Pure tungsten has about one sixth of the emission of thoriated tungsten, so that a tungsten filament tube should properly be compared with a thoriated tungsten filament tube drawing one sixth as much filament heating power.

Thoriated Tungsten Filaments

This type of cathode is justly popular as it is rugged and efficient when operated in a high vacuum. It requires a much higher vacuum than either the oxide-coated or the pure tungsten types and usually the "harder" the vacuum the longer the life of the filament. The main cause of short filament life in these tubes is gas, or an imperfect vacuum. To find the maximum safe space current, in milliamperes, multiply the filament heating power, in watts, by 5 for continuous service, and by 6 for intermittent service. As these ratings apply to class C operation, these figures can be slightly exceeded for class B audio use. When operating vacuum tubes with thoriated filaments it is very important to keep the filament voltage well up to rating. A thoriated filament run 10% high in filament voltage will usually last longer than one run only 5% low, assuming that it is being operated close to its space current limit. Note that most low-range a.c. voltmeters (even the expensive ones) can have an error of 10% or more; so besides keeping a filament voltmeter across the filament socket terminals of the most expensive tube in the transmitter, it is desirable to check the accuracy of the voltmeter regularly.

[Continued on Page 146]

Table D

TUBE TYPE	CATHODE			PLATE LOSS	μ	INTERELECTRODE CAPACITANCES			Base	COMMENTS
	Volts	Amps	Watts			Cgp	Cgf	Cpf		
808	7.5	4.0	30	50T	47	3	5	0.2	M4AD	TRIODE (U.H.F.)
WE305A	10	3.1	31	70M14	10.5	5.4	M4A	TETRODE (U.H.F.)
WE282A	10	3.0	30	70M2	12.2	6.8	M4A	TETRODE
50T	5	6.0	30	75T	12	2	2	0.2	M4AD	TRIODE (U.H.F.)
WE276A	10	3.0	30	100M	12	9	6	4	J4	TRIODE
HK154	5	6.5	32.5	5 T	6.7				M4BD	TRIODE
852	10	3.25	32.5	100M	12	3	2	1	M4BC	TRIODE (U.H.F.)
860	10	3.25	32.5	100M05	8.5	9	M4BC	TETRODE
850	10	3.25	32.5	109M	...	0.2	17	26	J4C	TETRODE
845	10	3.25	32.5	100C	5	15	8	7	J4	TRIODE
WE284A	10	3.25	32.5	109M	4.7	8.2	7	7.8	J4	TRIODE
WE284B	10	3.25	32.5	100C	5				J4	TRIODE
WE242A	10	3.25	32.5	109M	12.5	13	6.5	4	J4	TRIODE
WE242B	10	3.25	32.5	100C	12.5	13.6	7	6	J4	TRIODE
WE261A	10	3.25	32.5	100M	12	9	6.5	4	J4	TRIODE
211	10	3.25	32.5	100C	12	15	8	7	J4	TRIODE
WE295A	10	3.25	32.5	100C	25	14.5	6.5	5.5	J4	TRIODE
203A	10	3.25	32.5	100C	25	15	8	7	J4	TRIODE
838	10	3.25	32.5	100C	27	8	6.5	5	J4	TRIODE
805	10	3.25	32.5	125C	30	6.5	8.5	10.5	J4A	TRIODE
C201	10	3.25	32.5	125C	30	7	8	10	J4A	TRIODE
803	10	3.25	32.5	125C	...	0.15	15.5	28.5	J5A	PENTODE

Table D shows those transmitting tubes with between 25 and 35 watts of filament heating power.

Eight of these tubes are still rather new. This group might be termed the "200 watt group", speaking about output. Not all of the tubes are capable of 200 watts of output due to plate voltage limitations, but practically all of these tubes will run with normal class C plate current between 135 and 200 milliamperes. The new 808 is a close cousin to the 35T, RK35, and RK37. It has an extremely high μ and altogether with the low μ HK154 it shares the honor of having the highest filament heating power in proportion to plate loss rating. These tubes were made for high-efficiency circuits and both have low C construction and tantalum plates.

The WE282A is the tetrode widely used in the

50 watt phone sets used on the transport planes. The WE305B is somewhat similar to the 282A except that the screen and filament center tap connections come out the top of the envelope. The WE242C and the WE284B were designed for audio use but should find their way into ham stations. The 805 and the C201 are practically interchangeable except for slight differences in interelectrode capacitances. These two triodes have the highest plate loss ratings of the group.

This group includes most of the older tubes formerly known as the "fifty watters".

Maximum plate voltage ratings on this group range from 1250 volts for the older triodes to 3000 volts for the 50T and 852.



Plate Loss

The fifth column in the tube tables indicates the rated maximum plate loss, in watts. The letter following the loss figure describes the anode material. *N* is nickel; *M* is molybdenum; *T* is tantalum; *C* is carbon (graphite) and the absence of a letter indicates that the anode material is either one of the carbonized nickel or iron alloys or else the material is not given by the manufacturer. All the high voltage tubes use either molybdenum, carbon or tantalum. The anode material must radiate a certain amount of

heat without releasing any gas to poison the filament. As long as it fulfills this requirement it can be made of almost anything. It is desirable to have the anode able to withstand momentary overloads of rated dissipation and also, the smaller the anode, for a given dissipation, the lower will be the interelectrode capacitance and the better will be the ultra-high frequency performance of the tube.

Amplification Factor

The amplification factor of a vacuum tube describes the closeness of mesh of the control

Table E

TUBE TYPE	CATHODE			PLATE LOSS	μ	INTERELECTRODE CAPACITANCES			Base	COMMENTS
	Volts	Amps	Watts			Cgp	Cgf	Cpf		
F108A	10	11	*	175M	12	7	3	2	J4BC	TRIODE
HF200	10.5	3.4	35.7	150C	18	5.8	5.2	2	J4AD	TRIODE
T203B	10	3.85	38.5	50N	25	14	6	5	J4	TRIODE
T211C	10	3.85	38.5	100C	12.5	9	6	6.5	J4	TRIODE
RK36	5	8	40	100T	12	5	4.5	1	M4AD	TRIODE (U.H.F.)
RK38	5	8	40	100T	30	6	5	1	M4AD	TRIODE (U.H.F.)
T303C	10	4	40	125C	20	9	6	4	J4	TRIODE
THD203A	10	4	40	150C	25	12	7	5	J4A	TRIODE
THD203C	10	4	40	150C	20	9	6	4	J4A	TRIODE
THD211C	10	4	40	150C	12	9	5	4	J4A	TRIODE
T155	10	4	40	155C	20	3	2.5	1	J4AD	TRIODE (U.H.F.)
T814	10	4	40	200C	12	13	7	5.5	J4A	TRIODE
T822	10	4	40	200C	27	14	8	6	J4A	TRIODE
T200	10.5	4	42	200C	16	7	5	3	J4AD	TRIODE
204A	11	3.85	42.4	250C	25	16	14	3	J3A	TRIODE

Table E deals with those tubes with between 35 and 45 watts of filament heating power. These tubes might be termed the "200 milliamperere group", as the normal plate currents (class C) for the tubes in this group will range from about 175 ma. to about 225 ma. This group is new in that most of these tubes were unknown two years ago.

The F108A is included in this group although its peak filament emission is considerably less than any of the other tubes in the group. However, it can be driven to about the same c.w. power output as the

majority of this group, so was included. Its main virtue is its ruggedness, as it is practically impossible to hurt this tube.

The T203B has the lowest plate loss rating of the group, yet has very high filament emission. This is a low-voltage high-current tube. The 204A has the highest plate loss rating for the group as well as the highest interelectrode capacitances.

The T155 has the lowest interelectrode capacitances of the group.



grid. It allows the operator to determine "cut-off bias", by dividing the d.c. plate voltage by the amplification factor. It tells nothing about the grid to plate power gain through the tube, as a good low μ tube can be easier to excite than

some high μ tubes. The high μ tubes generally are better frequency multipliers and the low μ tubes generally are better class A audio power amplifiers and self-excited oscillators. For use as a power crystal oscillator the high μ tubes

Table F

TUBE TYPE	CATHODE			PLATE LOSS	μ	INTERELECTRODE CAPACITANCES			Base	COMMENTS
	Volts	Amps	Watts			Cgp	Cgf	Cpf		
HF300	11.5	4	16	200C	23				J4AD	TRIODE
RK28	10	5	50	100M02	15.5	5.5	J5A	PENTODE
150T	5	10	50	150T	12	3.2	3	1	J4AD	TRIODE (U.H.F.)
HK354	5	10	50	150T	11	4	9	0.2	J4A	TRIODE (U.H.F.)
849	11	5	55	350C	19	33.5	17	3	J3A	TRIODE
WE212E	14	6	84	275M	16	18.8	11.9	8.6	WE4	TRIODE
300T	7.5	12	90	300T	16	4	3.5	1.5	J4AD	TRIODE (U.H.F.)
WE270A	10	9.75	97.5	350M	16	21	18	2	WE2BC	TRIODE
831	11	10	110	400M	14	4	3.8	1.5	J3BC	TRIODE (U.H.F.)
861	11	10	110	400M	...	0.1	17	13	J3BC	TETRODE
HK255	14	30	*	500T	3	5	12	7	HK2BD	GRIDLESS TRIODE
F100A	11	25	*	500M	14	10	4	2	J3BC	TRIODE
500T	7.5	20	150	500T	14	4.5	4	1.5	4AD	TRIODE (U.H.F.)
851	11	15.5	171	750M	20	55	30	7	J3A	TRIODE
WE251A	10	16	160	1000M	10.5	8	10	6	WE2BC	TRIODE
WE279A	10	21	210	1200M	10	18	15	7	WE2BC	TRIODE
HK1554	11	17	187	750T	14.5	11	15.5	1.2	HK2AD	TRIODE
HK3054	16	50	800	1500T	20	15	25	2.5	HK3A	TRIODE

Table F deals with tubes of more than 45 watts of filament heating power. The smaller tubes in this wide group are the 225 to 300 ma. group of high-voltage, high-frequency tubes from which 500 to 600 watts of r.f. power can be obtained.

The RK28 pentode with its 50 watts of filament power is not entirely at home in this company, as far as power output is concerned, as its plate loss rating is only twice its filament heating power, or 100 watts. The 150T has the lowest interelectrode capacitances in the group with the HK354, 300T, and the 831 almost as low.

The new 212E is a modernized 212D. It should

not be used with over about 2000 volts of plate voltage above 1500 kc.

The HK255 and the F100A have materially less peak filament emission than the other tubes in this group, but their ruggedness makes them advantageous for rough commercial work. Two of these larger tubes use carbon anodes and the balance use molybdenum and tantalum in the ratio of 9 to 7.

The HK3054 has the distinction of being the world's largest radiation-cooled vacuum tube. In the hands of W6CUH a pair should be good for more than 20 kw.



seem to perform better. The question of *grid to plate power gain depends largely upon the action of the control grid when driven highly positive*, with respect to the filament. This factor cannot be shown in a tube table, as it depends upon two variables: plate resistance and grid resistance.

No amplification factor is shown for the tetrodes and pentodes (except for the smaller audio pentodes) as the μ varies widely with the screen voltage. In fact, in a perfect tetrode or pentode, cut-off bias would be determined solely from the screen voltage and would be independent of the plate voltage. This is due to the fact that in a multi-grid tube, the screen has more control over the plate current than has the plate voltage.

Interelectrode Capacitance

The seventh, eighth, and ninth columns show the capacitance between the different tube electrodes. In a triode the most important capacitance is the grid-to-plate capacitance, as it is this capacitance which must be neutralized to avoid regenerative feedback. In a multigrid tube the grid to plate capacitance is normally quite low, due to the presence of the screen grid, and it is the shunt input and output capacitances from grid and plate to ground that must be kept low for good performance at the high frequencies. A rough yardstick as to the high frequency performance of a tube is to add all three capacitances together. If they add up to less than 10 $\mu\text{pfd.}$, the tube probably will perform reasonably well at 60 megacycles.

Base Connections

The arrangement of the base and cap connections is shown in the tenth column. The detail of the base connections is not given, as those tubes using receiving tube bases will usually follow receiving tube practice. The bigger tubes will usually have so few base connections that there will be no difficulty in identifying them.

The letter preceding the number tells the type of base or socket used, and the number tells how many base pins are used for connections. Thus M4, 5, 6, 7 stand for the medium receiving tube base with the number of pins indicated. The letter O followed by 6, 7, or 8 indicates the newer receiving octal socket and the number of base pins. The J3 base is the RCA 250 watt type of base and socket; J4 stands for the standard 50 watt base and socket; J5 stands for the newer 5 pin Jumbo socket used on the 803 and RK28 pentodes.

The WE2 base is the Western Electric 2 pin, and the WE4 is the standard 212D and E type of base. All the big Gammatrons use special HK bases and the Eimac 500-T uses a special 4 pin base made by E. F. Johnson Co.

The letters which follow the number of pins in the base describe the connections on the top or side of the tube.

- A—PLATE LEAD OUT OF TOP
- B—PLATE LEAD OUT OF SIDE
- C—GRID LEAD OUT OF TOP
- D—GRID LEAD OUT OF SIDE

Exceptions include the 861, whose screen lead comes out the side, and the WE305A, whose filament center tap and screen connections come out the top.

The last column marked "comments" is self-explanatory.

Modern Transmitter Design

[Continued from Page 139]

except for class A amplifier applications, and few transmitting tubes find class A application any more. A large-scale curve of plate voltage vs. plate current for lots of different values of *positive* grid voltage, clear out to filament quasi-saturation, is desirable. These values for plate and grid voltages from zero out to between 200 and 500 volts *positive* on both electrodes should be shown. The constant current curves have more all-round utility, but any curves are satisfactory as long as they work out to quasi-saturation and are drawn on a large enough scale to allow accurate interpolation.

This matter of computing class A, B, and C performance is going to become very important soon as the method becomes more accurate and simplified, and before tube manufacturers start boasting about high performance and ease of driving they really should present the facts so that anyone can determine what their tubes can actually do, without expensive laboratory equipment.

Lyman M. Edwards, W5FJ, 822 So. Van Buren St.,
Enid, Okla.
Since Sept. 19, 1936
(28 Mc.)

D4FND-7; D4MDN-5; D4QBT-7; D4QET-5; E18B-7; F8E0-5;
F8KJ-6; F8OZ-7; F8WK-5; FT4AG-4; G2HG-5; G210-7; G5R1-5;
G5SJ-5; G5XG-7; G6CL-7; G6CW-5; G6DH-6; G6IR-6; G6LK-6;
G6NF-5; G6QB-5; G6RH-6; HK3JB-4; J2GL-3; J3FZ-5;
K6MVV-9; K6NRF-6; K6NTB-7; LAGA-8; LU1EL-3; LU6AX-7;
OE1FG-6; OE1FH-3; OH5NG-3; OK1AW-5; OK2MV-6; OK2OP-6;
OK3VA-8; ON4JB-5; ON4NC-7; OZ2M-8; OZ3FL-8; PA0AZ-6;
TI2EA-6; TI4AU-7; VK2GU-8; VK3YP-7; VK4AP-7; YM4AA-6;
ZE1JR-4; ZS1H-7; ZU1C-6; ZU6P-6.

Light, Inexpensive, "Multiband" Feeders

By J. G. CLAIBORNE, W5FDI*

While it has been generally accepted that the two-wire feeder as used in the Collins Multiband Antenna could be made of wire instead of the usual larger diameter tubing if the spacing were close enough to provide an impedance of 300 ohms, it has also been regarded as impractical because of the difficulty of maintaining sufficient rigidity.

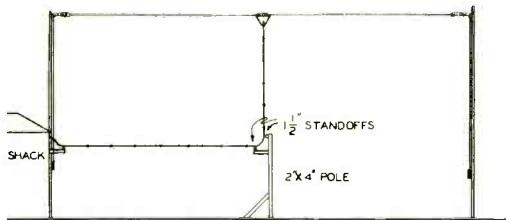

Figure 1

The multiband antenna installation using number 12 wire and knitting needles for the 300 ohm feeder. If the antenna is kept taut, the feeders will keep their spacing indefinitely, in spite of the fact that it is only about an inch.

The following is a description of the method used at the writer's station for constructing a "Multiband" antenna of the proper characteristics and using low-cost materials with entirely satisfactory results.

A trip to a local dry goods store disclosed the fact that the largest celluloid knitting needles stocked were 3/16" in diameter. Each needle was long enough to provide 10 pieces 1 1/4" long; so 7 pairs of them were purchased at 35c per pair. Two holes of a size to take no. 12 enameled wire snugly were drilled in each spreader-to-be and a sufficient number of these midget spreaders were provided for spacing at 25 inch intervals throughout the entire length of the feeder needed in this particular installation.

Next, two lengths of no. 12 enameled wire about an inch apart were stretched and strung between two pair of supports. The proper number of spreaders were slipped on and each wire was provided with a turnbuckle at one end. By taking up on turnbuckles the wire was stretched out as tight as the proverbial drum. The spreaders were then slid in their proper positions and spreaders and wire were heavily doped with

Duco cement at the points where the wires went through the spreaders. This was allowed to dry for 12 hours and then a second daubing was applied and let dry for 24 hours.

The resulting feeder line is so stiff that a 5 foot length of it can be held by one end with little or no bending. The length of feeder is attached to the flat top as shown in figure 1 and by using the square piece of bakelite tied to the insulator and feeders as shown in the cut, the plane of the feeders can be swung around without any danger of the wires crossing up with each other.

The particular installation here is shown in figure 1. The flat top is approximately 136 feet in length, which is 4 1/2 waves at 20 meters, and the feeders are 102 feet in length to the transmitter, which is a Collins π network coupler. As shown in the drawing, the antenna feeder drops to an 8 foot pole and is fastened to a couple of standoff insulators in a 20" curve and proceeds from there to the shack. With the an-

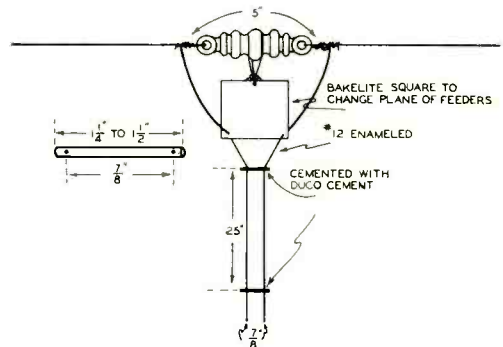

Figure 2

A hard rubber or low-loss bakelite square is used to change the plane of the feeders.

tenna flat top pulled up tight the vertical portion of the feeder is perfectly rigid and the horizontal part is essentially stretched. The system is mechanically sound as this installation has been up six months and the feeders are in perfect shape with no loose spreaders.

This antenna is used on all bands from 80 meters to 10 with excellent results, and the coupler will also tune it to 160 meters. A fellow ham uses one of the same construction but with 66 foot flat top and 115 foot spreaders with very satisfactory results.

*1010 San Jacinto Bldg., Beaumont, Texas.



Figure 1

The four oscillators comprising the "group 1" standard, in use since 1929.

The Primary Radio Frequency Standard

By RUFUS P. TURNER, WIAY

Even those who suffer the slightest exposure to scientific study learn that at Washington the Government has a special place for all its *yardsticks* of weight and measure. That great depository is the Bureau of Standards. And at the Bureau, along with the more prosaic standards of weight, measure, temperature, and the like is the standard of radio frequency. This is the *primary* standard, the first and last authority with which every kilocycle throughout the land, in order to be a real kc., must agree. There are standards and standards *ad infinitum*, and so the primary radio frequency standard is in turn compared with standard time!

During the past ten years, the primary standards have taken various shapes, the increasingly rigorous demands imposed by radio progress having necessitated periodic changes and improvements. The first standard wavelength circuits were supplanted by vacuum tube-driven tuning forks coupled to a string of harmonic amplifiers. And then the relatively simple temperature-controlled crystal oscillators, which constituted the next evolutionary step, were superseded by the present complex line-up of crystal oscillators maintained under conditions which insure the generation of a constant

frequency—as constant as the state of the art permits. In this present system, such factors as variations in temperature, humidity, atmospheric pressure, and operating voltages which would affect the frequency of a piezo-electric oscillator are controlled to a fine degree.

Description

Two independent groups of crystal oscillators comprise the primary radio frequency standard. The first group, in use since 1929, contains four 100-k.c. oscillators developed by the Bell Telephone Laboratories (figure 1). The second group contains two oscillators: one operating at 100 k.c., the other at 200 k.c. with a submultiple generator to supply a 100-k.c. output.

The quartz plates employed in group I are doughnut-shaped, a type of cut which reduces the frequency drift due to temperature variations to 1 part in a million per Centigrade degree. A horizontal fiber rod, passing through the central hole, serves as a support for the plate. The electrodes are aluminum discs at either end of this rod, spaced by a section of pyrex tubing. The entire assembly is wrapped in felt, half a centimeter thick, and enclosed in a thick-walled aluminum cylinder around the



outside of which are wound heater coils for maintaining the temperature of the plate within a thousandth of a degree Centigrade. Within the cylinder wall are placed the thermometer and the thermo-regulator, and alternate heat-attenuating layers of felt and copper enclose the cylinder. This complete temperature-controlled plate chamber is mounted on a brass plate, and over it a bell jar is sealed with a special wax developed for the purpose. The pressure within the jar, as indicated by a closed tube manometer, is approximately 5 cm. of mercury lower than atmospheric.

The complete oscillator-amplifier units associated with the quartz plates are mounted on damped springs under the plate chamber in a temperature-controlled cabinet (figure 1). The oscillator circuits are conventional but with their tuned plate circuits so designed that temperature changes and aging of the components have small effect.

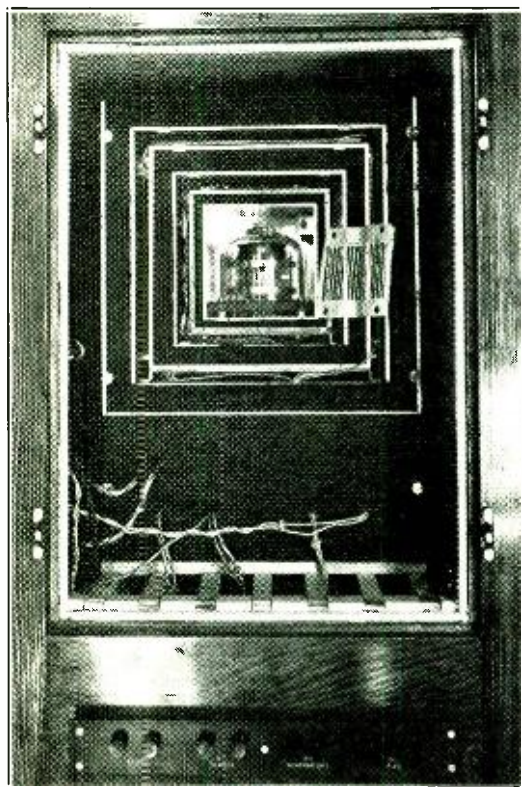

Figure 2

First of the oscillators of group 2. The quartz plate is sealed inside a bell jar with pressure reduced to half an atmosphere.

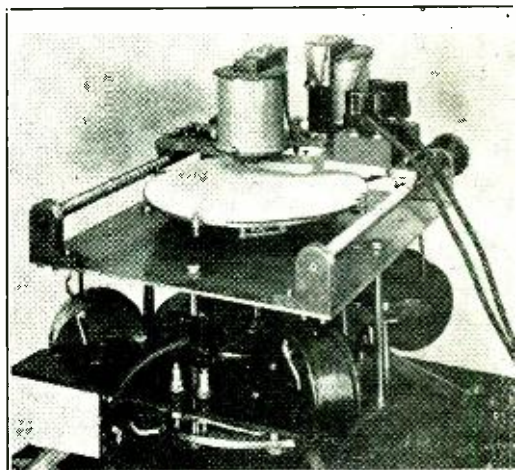

Figure 3

The chronograph which checks the standards, giving graphical indication of any variation.

In setting the oscillators to the 100-k.c. frequency, a coarse adjustment is made by varying the air gap in the plate holder. A finer adjustment is possible by changing the air pressure within the bell jar. (It is possible to increase the frequency 1 part in 10 million for each increase in pressure of 1 cm. of mercury.) The finest adjustment is made with a variable condenser of 5 μmfd . maximum capacitance connected in parallel with the plate holder electrodes.

Figure 2 shows the first of the two oscillators in group II. Here the 100-kc. quartz plate is circular with its cylindrical surface V-grooved to admit three pointed mounting screws spaced 120 degrees apart. The mounting rests on a pyrex base plate sealed over with a bell jar within which the pressure is reduced to half an atmosphere. The second group II oscillator, still in the experimental state, employs a Y-cut circular quartz plate the frequency of which is 200 kc. The plate is of unique shape—resembling a wheel with a large outer rim and small central hub, with two thin spokes holding the two together. A small web was left in the center by drilling the hub on both sides. Short metal rods fitted into the holes on either side of the hub support the quartz wheel and its circular electrodes. Though this type of plate is exceedingly fragile and difficult to prepare, its use is justified by increased stability. Its temperature coefficient is approximately 1 part in a million per degree

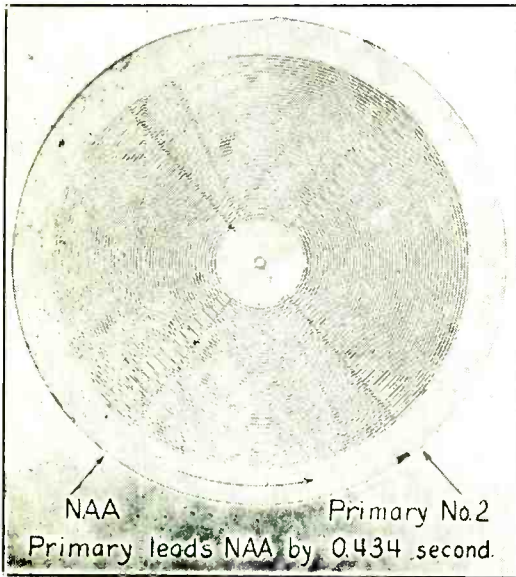

Figure 4

A time signal record made by the disc chronograph.

Centigrade, and a one-hundred per cent increase in the plate voltage of the "wheel oscillator" causes a frequency change of less than 1 part in a million.

Checking the Standard

One oscillator in group I is used for reference. Amplifiers associated with the other three furnish output voltages for comparison with the reference unit or for driving a series of multivibrators which in turn furnish output voltages at 1 kc. and 10 kc., exact submultiples of the plate frequency. The 1 kc. output is used to drive a 1,000-cycle synchronous clock which will keep correct time, as compared with NAA time signals, if the plate frequency is exactly 100 kc. Generators of 10 and 100 cycles per second are driven directly by the shaft of the clock motor.

The actual number of vibrations of the quartz plate in a known time interval is determined when calculating the absolute frequency of any oscillator in the Standard. (100,000 vibrations of the plate are required for each second indicated by the clock.) A cam-operated contact in the clock provides second pulses which operate a stylus on a chronograph (figure 3). Radio time signals operate a second stylus, and the two trace almost coincident spiral lines on a paper record. The Bureau says, "The angle between each set of radial lines on the record is read on a graduated circle and interpreted as

seconds difference in time between the two time signals (the one from NAA; the other from the clock operated by the Primary Standard). 180 degrees on the record represents 1 second of time." The absolute frequency of only one oscillator in each section is determined. The others are checked against this one by means of beat indicators and associated counters and recorders. The clocks operated by the Standard are checked against NAA time signals and against the Shortt clock at the Bureau.

The Bureau says, "The frequency of the Primary Standard is calculated over a 10-day interval in terms of the uncorrected time signals and over a 6-day interval in terms of corrected time signals. The 10-day interval is required to give the desired accuracy as there is a maximum probable error in the time interval, as indicated by the uncorrected time signals, of 0.06 second which, if averaged over a 10-day period, reduces the maximum probable error in the frequency determination, due to this cause, to 7 parts per 100 million. This factor is considerably larger than the probable error caused by inaccuracies in the determination of the number of vibrations of the quartz plate in the time interval. The error in this measurement is not greater than plus or minus 0.002 second or plus or minus 200 cycles, which would cause an error in the frequency determination over a 10-day interval of only 0.5 part per 100 million. The maximum errors in terms of the corrected time signals over a 6-day period are 4 parts per 100 million due to error in the time interval and 0.8 part per 100 million due to error in the determination of the vibrations of the quartz plate." In connection with the oscillators which drive the synchronous clocks, it is interesting to know that the frequency drift may be plus or minus 3 parts per million per month. The average frequency increases over the yearly period, the maximum deviation from average being plus or minus 1 part per million per year.

Power Supplies

Separate power is provided for each group of oscillators and amplifiers in the Primary Standard. Group I requires 700 watts; Group II, 400 watts continuously. This does not take into account the power required to drive relays and motors and to heat the crystal chambers. Batteries are used, and the charging rate is adjusted automatically "to maintain the working battery voltage constant to better than 1 per cent." Voltage control units keep filament and plate voltages constant.



Dissemination of the Standard Frequencies

Public access to the Primary Standard may be had by means of radio or land wire. For four years, the Bureau has transmitted from its station, WWV in nearby Beltsville, Maryland, a 5,000 kc. signal for calibration purposes, the constancy of which is maintained by comparison with the Standard. Amateurs are probably more familiar with WWV's standard frequency transmissions on 10 and 15 megacycles occurring every Tuesday, Wednesday, and Friday

afternoon, except holidays. Because of the expense of long telephone lines, direct wire connection to the Primary Standard is limited to users in the Washington area.

Acknowledgement

RADIO is indebted to the Director of the National Bureau of Standards for the photographs reproduced in this article and for Research Paper RP759, from which we have quoted, and to which readers are referred for more detailed information concerning the Primary Standard of radio frequency.

Monthly Radio Photo Contest

CASH PRIZE FOR BEST SNAPSHOT

The late Hiram Percy Maxim, "Grand Old Man of amateur radio", was only one of many radio amateurs who have an interest in amateur photography. Realizing this, and the fact that interesting pictures are a desirable addition to any magazine, radio or otherwise, we are starting a monthly photo contest, to run until further notice.

The photos may be of any kind, just so that they are at least remotely connected with amateur or commercial radio. They may be unusual shots of common apparatus, common shots of unusual apparatus, candid camera shots of well-known amateur radio personalities.

For the best photo each month we will pay \$5.00 in cash. For all those published, we will pay \$1.00 each. Unused snapshots will not be returned unless accompanied by a stamped, self-addressed envelope. When sending snapshots, be careful not to mar them with paper clips. Wrap each photo separately in a piece of writing or tissue paper if you want them to arrive in top condition.

The photo to the right will give you an idea for one interesting study. It is the vertical radiator of WQPS, the station of the Illinois State Police.

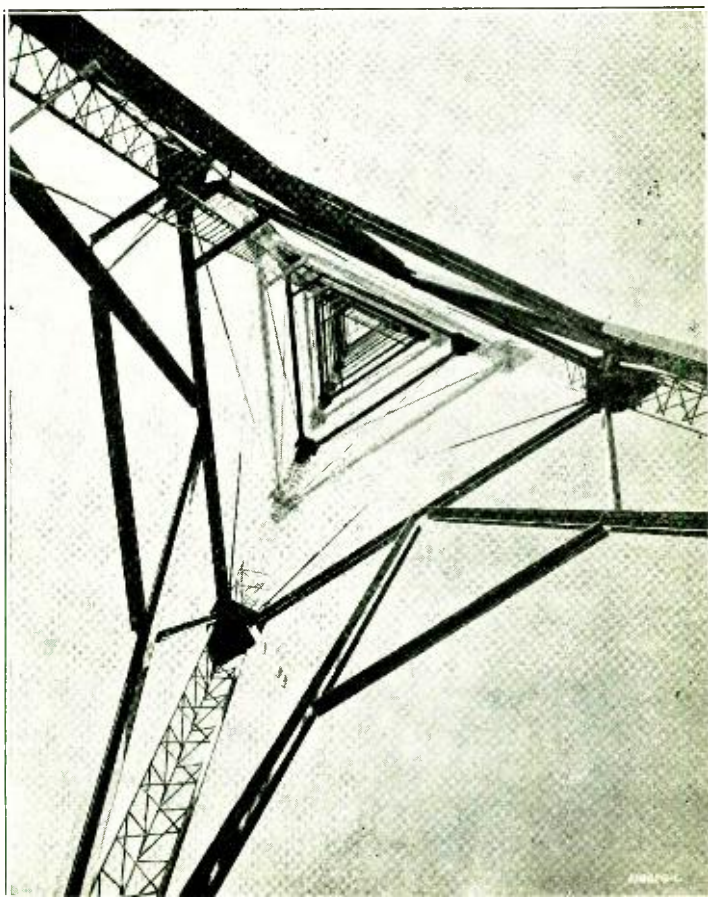

A Most Economical 100 Watt Phone

By FAUST GONSETT, W6VR

The most common medium-power grid-modulated rig uses a 211 or 203-A (100 to 125 watts plate dissipation) and delivers about 40 to 50 watts of carrier. We can double the output by using two of these tubes in push-pull, but the tubes cost twice as much. What we are after is a tube with "lots of plate dissipation per dollar", as the plate dissipation

This transmitter gives just about the maximum in watts per dollar for a phone transmitter. It delivers 110 watts on 75 and 160 meters, and about 90 watts of carrier on 20 meters. It requires but one inexpensive high-voltage supply, which need not have good regulation, and needs no expensive modulating equipment.

the amplifier and its power supply. The outputs listed were obtained with very low distortion at 95% modulation of the amplifier, and represent a very high "watts per dollar" factor that would be hard to match with a high-level modulated transmitter of the same output.

As has been repeatedly pointed out, a grid-modulated stage works into a much lower impedance load (tighter antenna coupling) when properly adjusted than does a plate-modulated class C amplifier. For this reason, the plate tank should not be low "C", but rather "medium C", especially in a single-ended amplifier as is this one. With a plate tank condenser of the value specified in the diagram, the coils should be "pruned" so that the condenser resonates with plates nearly all the way in for 160 meters, 2/3 of the way in on 75 meters, and a little less than half way in for 20 meters.

The amplifier is neutralized in the conventional manner by the "grid dip" method. The swamping lamp is uncoupled and the excitation run up to give a more substantial reading on the grid meter. This makes the neutralizing process a more simple matter. After the neutralizing, the lamp is coupled up to nearly normal brilliancy. The excitation is adjusted to the 814 (as read by the grid meter) until the stage modulates up properly when the antenna is coupled so as to load the amplifier to 200 ma. At rated input, if the stage modulates downwards the excitation must be reduced, and the antenna coupling increased to bring the input back up to 300 watts. If the tube runs too hot at 300 watts input, it will be necessary to decrease the antenna coupling and then bring the input back up to 300 watts by increasing the excitation. When the right combination of excitation and loading is obtained, the tube will be running at normal dissipation and the distortion will be quite low at 95% modulation. The plate meter will kick upwards very slightly on modulation peaks and an r.f. indicator coupled to the output tank or feeders will give an occasional upward kick. The modulation may be checked by means of any of the common modulation monitors described in recent issues of RADIO.

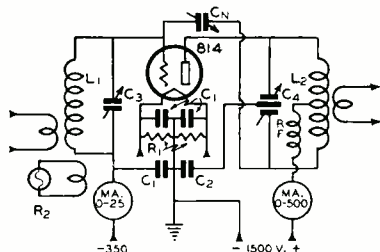

Wiring Diagram of the 100-Watt Grid-Modulated Stage

- | | |
|--------------------------------|-----------------------------------|
| C ₁ —01 μfd. mica | NC—25 μfd., 6000 |
| C ₂ —002 μfd. mica, | volt spacing |
| 5000 volts | R ₁ —30 ohms, c.t., 10 |
| C ₃ —100 μfd., 2000 | watts |
| volt spacing | R ₂ —32 volt 15 watt |
| C ₄ —210 μfd. per | "farm" Mazda |
| section, 3000 volt | lamp |
| spacing | |

is the chief limiting factor of output in a grid-modulated rig. The 814, with its 200-watt plate dissipation, is probably the most economical tube from this standpoint. With this in mind, and also with Mr. Oleson's article* on increasing the efficiency of a grid-modulated amplifier fresh in our memory, we proceeded to see what we could do. The amplifier seen in the photograph is the result.

With a 1500 volt power supply, the transmitter delivers 110 watts on 75 and 160 meters, and about 90 watts on 20 meters. These outputs are obtained without exceeding the rated maximum plate dissipation of the tube. By using a higher-voltage power supply it should be possible to get more output with the same plate dissipation, but the slight increase in output was not considered worth while. Higher voltage tuning and filter condensers would be required, substantially increasing the cost of

*RADIO, November, 1936, Page 56.

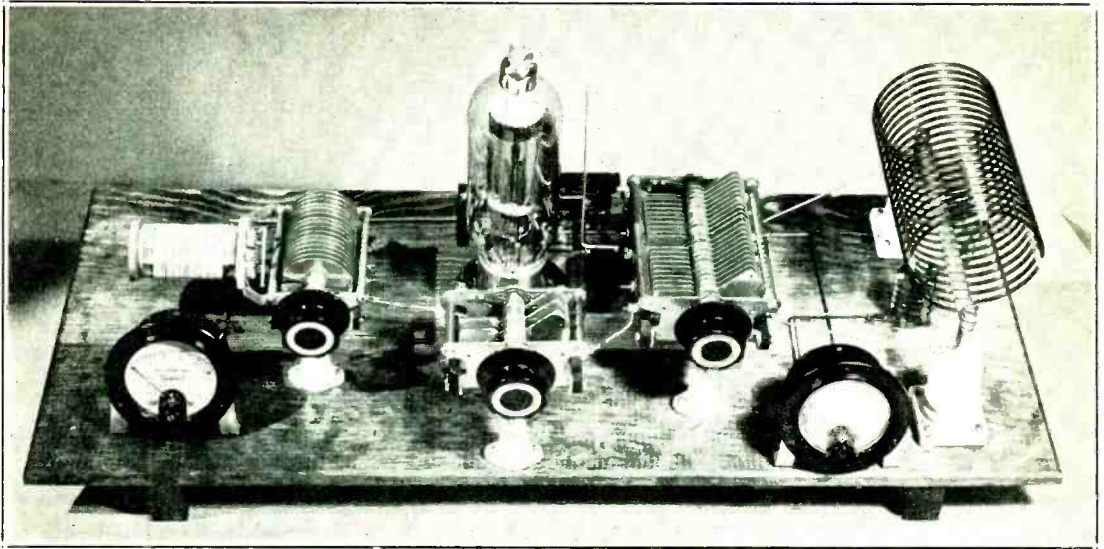

The 20-, 75-, and 160-meter grid-modulated amplifier. The frames of the grid and plate tank tuning condensers are "cold" to r.f. They are mounted on "stand-offs" merely for the sake of appearance.

When properly adjusted, the harmonic distortion is lower at 95% modulation than with the majority of plate-modulated rigs on the air, but as is characteristic of all grid bias modulated transmitters, the distortion climbs very fast between 95% and 100% modulation. But as we have yet to see a pair of ears that can tell the difference in strength between 95% modulation and 100% modulation, this is of little consequence.

The power supply need not have good regulation, as the plate current swings but 5% or so under modulation. A slight voltage drop due to poor regulation would do about as much good as harm anyhow, as it would tend to buck the slight upward carrier shift that is characteristic of this type grid-modulated amplifier when fully modulated. Do not be alarmed about the mention of carrier shift. It is almost imperceptible when the transmitter is properly adjusted, and is no greater than that of 90% of the high-level-modulated transmitters used by amateurs. As the power supply need not have good regulation, it can be constructed at a lower cost. You may even use condenser input if you wish. The only requirements are that it be free from hum and that it deliver 1500 volts at a load of 200 ma.

The rest of the transmitter is conventional, hence is not shown. The r.f. lineup consists of a 6A6 exciter, link coupled to a 6A3, which is

link coupled to the grid-modulated amplifier. The 6A6 exciter has a 100 ma. power supply that delivers 350 volts under load. The positive of this supply is grounded and 350 volts of negative bias obtained in this way for the grid-modulated stage. The 6A6 exciter acts as a low-resistance bleeder, giving good regulation to the bias voltage, a well-regulated low-resistance bias supply being absolutely necessary for a grid-modulated stage. This supply should be well filtered, as any ripple in the supply will show up multiplied in the carrier. (1% ripple will modulate the carrier several per cent.) This is because the grid-modulated amplifier is biased to approximately 3 times cutoff, and is "modulation gaining" with the low values of excitation used.

For the same reason the 6A3 power supply should be well filtered, because if the r.f. output of the 6A3 is modulated, the percentage ripple will be multiplied by the 814 stage. However, the 6A3 supply is only 425 volts, and it may use cheap electrolytic condensers as does the 6A6 350-volt power supply.

Thus for the r.f. section, we have a 6A6, a 6A3, and an 814. We have three power supplies to feed the r.f. section: A 350-volt 100 ma. supply for the 6A6 (and 814 bias), a 425-volt 100 ma. supply for the 6A3, and a 1500-volt 200 ma. supply for the 814.

[Continued on Page 159]

Looking Them Over

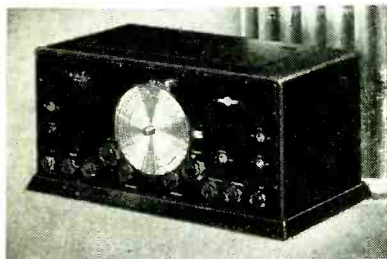

The "Ultra Skyrider"

To assist prospective purchasers in the better comparison of the current communications receivers it was deemed advisable to present some of the important electrical and mechanical features in uniform chart form. With this idea in mind, blank forms were sent to all the better-known receiver manufacturers, with spaces where they could fill in the information requested in the chart. All the information given by the manufacturers that returned the forms was then tabulated in the chart shown.

Perhaps a brief discussion of the information given in the table might help to clarify the reason for its presentation.

Band spread can ordinarily be classed as either electrical or mechanical. By electrical is meant that the band-spreading is obtained either by means of a tapped coil arrangement such as used in the HRO, or by a separate shunt



The "Super Pro"

variable condenser paralleled with the regular tuning condenser and having its own separate tuning dial. This latter method is commonly employed in the Hammarlund and Skyrider receivers. By mechanical we mean geared-down dial arrangement. National and RCA make use of this system.

The tuning ratio is self-explanatory; it merely indicates the number of kc. per knob rotation and the number of kc. occupied by the smallest scale division on the band spread dial. The smaller the number of kc. taken up per division, the more the bands will be spread over the dial.

From the column "I.f. band width in kc.," the selectivity characteristics of the receiver can be figured. The figures indicate the shape of the band passed by the i.f. channel. The narrower the band, as indicated by the figures in the column, the more selective the set will be to interfering signals. In the "Image Ratio"

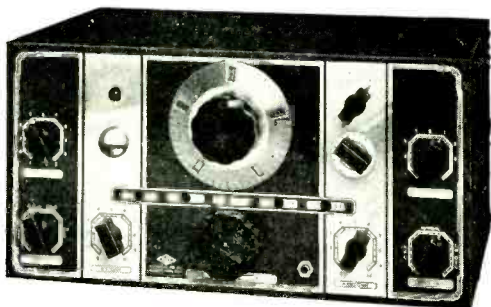

The NC-100

column, the figures indicate the ratio of the image signal to the desired signal required to give the same output in the phones or speaker. Obviously, the larger this ratio, the less trouble will be experienced from undesired image response.

The other columns are practically self-explanatory. One other thing however: the fact that the d.c. plate current is isolated from the phone jack in all the receivers listed indicates that crystal phones can be used without any fear of damaging them.

The Hammarlund "Super Pro"

The "Super Pro" is a 14 tube communications receiver having a separate speaker and power supply. The power supply utilizes two additional tubes as plate and bias rectifiers, making a grand total of 16. Two r.f. stages are used on all bands and the i.f. amplifier has three cascaded stages, making the receiver both unusually selective and free from image response troubles.

A separate uncalibrated band-spread dial is

used to make the amateur bands cover more dial divisions. High audio output is made available by the use of a pair of triode-connected 42's in the output stage operating with fixed bias. A milliammeter in the common plate lead of all three i.f. tubes indicates the incoming carrier strength.

Another control is provided for varying the selectivity of the intermediate amplifier. This allows optional high selectivity for general ham reception, or any amount of broadening for better audio quality of the output. The Super Pro covers all frequencies from 540 to 20,000 kc. in five wave bands.

The "Super Skyrider"

The 1937 Super Skyrider is an 11 tube super-heterodyne covering the range from 545 kc. to 38.10 Mc. in five wavebands. It uses metal tubes throughout with the exception of the 6G5

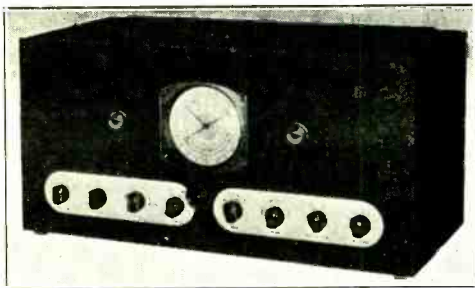

The ACR-175

tuning indicator. Push-pull 6L6's are utilized in the final audio stage, enabling from 14 to 17 watts of audio to be obtained without overload. Iron-core intermediates in combination with a special impedance-matching transformer for the crystal filter contribute to the unusually good selectivity obtained.

Output impedances of 5000 and 500 ohms are available for either an external load or the permanent magnet dynamic recommended for use with the set. Through the use of a choke in the power supply instead of the more usual arrangement of using the speaker field in the filter, the set can be run normally without the speaker connected. This is advantageous when using the phones for reception.

The "Ultra Skyrider"

The Hallicrafters Ultra Skyrider is designed to fill a somewhat different need than the ordinary communications receiver. It covers only the higher frequency bands, from 5.65 Mc. to 80 Mc. It employs ten tubes in a superheterodyne circuit and covers the above range in four

wavebands. A special 1600 kc. i.f. circuit is used whereby sharp, medium, or broadened selectivity can be obtained by means of a switch on the front panel.

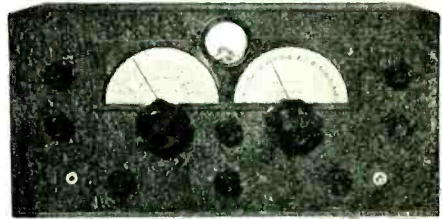

The RME-69

In addition there is a self-contained noise silencer and a control on the b.f.o. injection, both of which help in ultra-high reception. An optional crystal filter is supplied if desired. The receiver is designed for a separate permanent magnet dynamic speaker, a similar arrangement to that used in the standard Skyrider.

It is an excellent receiver for the ham only interested in the bands from 5 through 40 meters, giving performance difficult to match in an all-wave receiver.

The ACR-175

This is a special 11 tube superheterodyne covering the range from 500 kc. to 60 Mc. in four bands. A crystal filter is supplied as standard equipment and its selectivity is controlled by a knob on the front panel. A 6E5 "magic eye" tube with a special input control calibrated in microvolts gives a fairly accurate idea of the incoming signal strength.

Special permeability-tuned, iron-core transformers are used in the intermediate amplifier; these eliminate, to a large extent, the drifting



The "Super Skyrider"

and instability characteristic of most of the old mica-compression tuned units.

A large airplane-type dial calibrated in kc., and a special knob arrangement with a tuning ratio of either 20:1 or 100:1 comprise the tuning equipment.

MAKE	Band Spread	Tuning Ratio		I. F. Bandwidth in K.C. (times resonant input voltage)	Frequency Range each band	Image Ratio Each Band					Crystal Filter	D. C. Isolated from phones?	A. F. output (7% distortion)	Speaker or output provision	Tuning Provision	Antenna Provision	Noise sh- tencer	I. F. frequency	High r. f. stages on each band	Dial mechanism	Approx. h. f. osc. drift at 14 mc. 15 min. from "stone" cold—room temp. 70-80° F.			
		Band	Kc./Knob rotation			Kc./Scale division	1	2	3	4												5		
RME 69	Electrical	2 mc.	12.5	1.4	1 500-1500 kc.	2	2500/1																	
		3.5 mc.	25	2.8	2 1.4-3.1 mc.	3	1000/1																	
		7 mc.	30	3.3	3 3.6-4 mc.	4	500/1	Yes																
		14 mc.	72	8	4 6.2-13 mc.	5	200/1																	
		28 mc.	200	22	5 12-20 mc.	6	50/1																	
		2 mc.	250	20	6 17-32 mc.	2	54,000/1																	
Hammarlund Super Pro	Electrical	3.5 mc.	100	4	1 540-1160 kc.	3	13,500/1	Yes																
		7 mc.	75	5	2 1160-2500 kc.	4	8000/1																	
		14 mc.	100	5	3 2.5-5 mc.	5	1600/1																	
		2 mc.		1.2	4 5-10 mc.																			
		3.5 mc.		2	5 10-20 mc.																			
Super Skyriders	Electrical	7 mc.	3	2.5	1 545-1230 kc.																			
		14 mc.	8		2 1180-2850 kc.																			
		28 mc.	19		3 2.75-6.82 mc.																			
		7 mc.	1.9		4 6.75-16.4 mc.																			
		14 mc.	3.5		5 15.4-38.1 mc.																			
Ultra Skyriders	Electrical	7 mc.	11	22.2	1 5.6-11.4 mc.	1	2200/1	Yes																
		14 mc.	11		2 10.5-21.4 mc.	2	352/1																	
		28 mc.	11		3 19.8-38.2 mc.	3	132/1																	
		56 mc.		90	4 37-79.5 mc.	4	12/1																	
		2 mc.	28.5	1.3	Max. selectivity	A 500-1600 kc.	2 mc.	15,000/1																
A C R 175	Mechanical	4 mc.	133	3.5	1 1600-6200 kc.	4 mc.	8000/1																	
		7 mc.	120	3.1	2 10.5-21.4 mc.	7 mc.	27.5/1																	
		14 mc.	206	7.3	3 19.8-38.2 mc.	14 mc.	150/1	Yes																
		28 mc.	1000	27	4 37-79.5 mc.	28 mc.	3/1																	
		56 mc.	2000	54	Min. selectivity	D 15,450-60,000 kc.	56 mc.	2/1																
H R O	Mechanical and Electrical	2 mc.	33	7	1 1.7-4.0 mc.																			
		4 mc.	36	1.25	2 3.5-7.3 mc.																			
		7 mc.	35	.65	3 7.0-14.4 mc.																			
		14 mc.	45	1.0	4 14.0-30 mc.																			
		2 mc.	200	4	1 54-113 mc.																			
N C 100	Mechanical	4 mc.	350	7	2 1.3-2.8 mc.																			
		7 mc.	700	14	3 2.7-6.4 mc.																			
		14 mc.	1450	29	4 5.9-14.4 mc.																			
					5 13.5-30 mc.																			



The National "HRO"

The HRO is a high-frequency superheterodyne employing nine glass tubes. The power supply is a separate unit and uses another tube, an 80 rectifier. The receiver comes equipped with four plug-in coil assemblies that cover the range from 1.7 to 30.0 Mc. Additional assemblies are available to cover the range from 175 kc. through the broadcast band.

A calibrated "S meter" is provided to give an idea of the incoming signal strength. Airtuned i.f. transformers and an efficient crystal filter are standard equipment on all receivers.

An unusual dial having an effective scale length of the order of 12 ft. provides very easy tuning. In addition, a jumper on the coils can be shifted to spread each ham band over almost the whole dial. Remarkable band-spread is provided with the coils set up in this way.

The National "NC-100"

The NC-100 employs 12 tubes in a superheterodyne circuit to cover the range from 540 to 30,000 kc. in five wavebands. Metal tubes are used throughout with the exception of the 6E5 tuning indicator and the 80 rectifier. A self-contained power supply is employed to supply the receiver with plate voltage and the speaker field with excitation.

An efficient system of automatic plug-in coils is employed whereby any of the five wavebands may be obtained through a switch on the front panel. Each coil with its associated trimming condenser is contained in a separate compartment in the large, aluminum shield housing all the coil units. By means of a rack and pinion system this shield may be moved back and forth to engage the coils desired.

A separate speaker, with a baffle box if desired, is provided with the receiver.

The RME-69

The RME-69 is a nine-tube communications receiver combining a number of convenient and desirable features. The range from 550 to 32,000 kc. is covered in six steps and the set employs a one stage pre-selector throughout. Bandspread is obtained electrically through a separate dial mounted to the right of the regular tuning dial, driving a ganged bandspread condenser.

Two handy features are the built-in modulation monitor for checking your own transmitter and an optional noise silencer unit that can be installed inside the cabinet with the controls brought out on the front panel. A signal strength meter calibrated both in "R" and db

units, and a variable-selectivity crystal filter unit are included in the standard receiver. Output provision is made for either a permanent magnet dynamic speaker or a 600 ohm external load.

Economical Phone

[Continued from Page 155]

The 6A3 was used to drive the 814 because the 6A3 has low impedance and good r.f. regulation. To improve the regulation further, a 15-watt, 32-volt (farm lighting) lamp is link coupled to the grid tank of the 814 as a "stabilizing load". This is preferable to wiring a "swamping resistor" permanently in the circuit, as it allows one to get just the right adjustment when changing bands. The link to the swamping lamp is adjusted for each band until the lamp glows with just slightly less than normal brilliancy. This combination of low-impedance r.f. driver and load stabilizer permits a substantial increase in the output obtainable for a given amount of distortion at full modulation.

The desirability of good regulation was kept in mind also in picking a modulator. For this reason push-pull 6A3's were used in the output speech stage. The varying load offered by the grid of the 814 under modulation has little effect upon the audio waveform of the 6A3's. The output of the 6A3's is coupled to the 814 through a transformer designed to work out of 6A3 drivers into class B 203-A grids. The whole secondary is connected in series with the lead to the bias supply. What line-up goes ahead of the push-pull 6A3's depends upon your own microphone and pet ideas as to tubes.

At first glance it would look as though the 3000-volt spacing of the plate tank tuning condenser of the 814 stage would not be sufficient to stand the modulation peaks. However, due to the fact that the tank is fairly high "C" and because the tube works into a very low impedance load (tightly coupled to the antenna) no trouble with arcing is encountered. This permits a relatively inexpensive tuning condenser to be used.

Who remembers Crystalman Bliley's early articles on short-wave wavemeters . . . When E. T. Cunningham was President of the old Remler firm . . . When Ballantine's *Radiotelephony for Amateurs* was the Bible and prayer book for hams.

A Home-Made Band-Switching Receiver

By MELVIN O. KAPPLER*, W6LDB

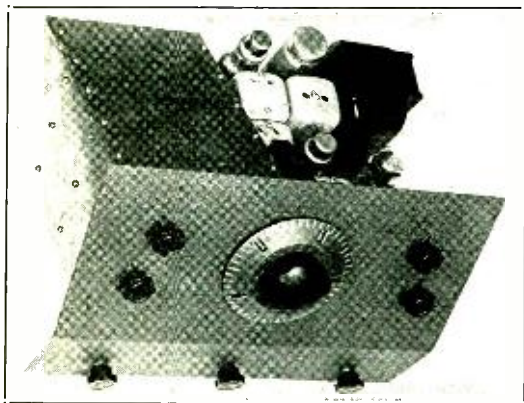

Looking down on the front of the bandswitching receiver. Note sloping panel.

With the announcement on the market of commercial receivers by several reputable manufacturers all priced near the one hundred dollar mark, the problem for the designer of an amateur communication receiver to be built at home becomes much more complicated. Since the cost of parts will be approximately seventy dollars, the builder would generally prefer to pay the extra thirty dollars or so for the advantage of band switching, if for nothing else. Hence, the home-made receiver of today must have provision for changing bands from the front of the panel. Of course, many fellows do not wish to undertake the tedious process of gathering the parts, cabinet, and ideas for their own receiver, but those who do take pleasure in building, as well as operating, would never be content without the convenience and satisfaction of a receiver whose controls, and their location, were of their own design. It was for these fellows that this article was written. Fortunately, there are now available matched sets of coils so carefully designed as to give excellent performance on all bands, and switches may be obtained for changing them. The only remaining problem is that of a suitable mechanical layout affording adequate shielding and yet permitting the band switch and tuning controls to be ganged. It might be noted at this point that extra coils for the same purpose,

located near each other in the same shield can, do not have any effect upon the action of the receiver other than a change of tuning. If you doubt this you may prove it to yourself by tuning in a signal on a plug-in coil receiver, then inserting several coils for other bands in the can. You will notice that the signal is slightly detuned, but the R-strength remains unchanged.

Up to this time the coils for a band-switching receiver have had to be wound at home. The result was that even those ambitious hams who did think of a home-made receiver of this type gave up in the face of such problems as coupling between stages, matching the plate impedance of radio frequency amplifier tubes, and oscillator coupling to the first detector. These considerations have been taken out of the "cut and try" class by the commercial coil sets, which have carefully-designed primaries and matched secondaries for ease of ganging.

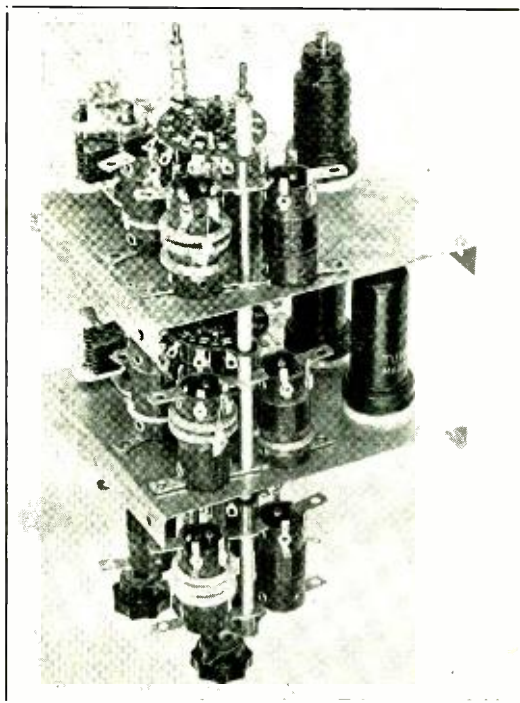

Internal view of the heart of the receiver, the bandswitching assembly. It is built from a ready-made coil foundation unit.

*Electronic Sound Laboratories, Inc., 5912 Melrose Avenue, Hollywood, California.

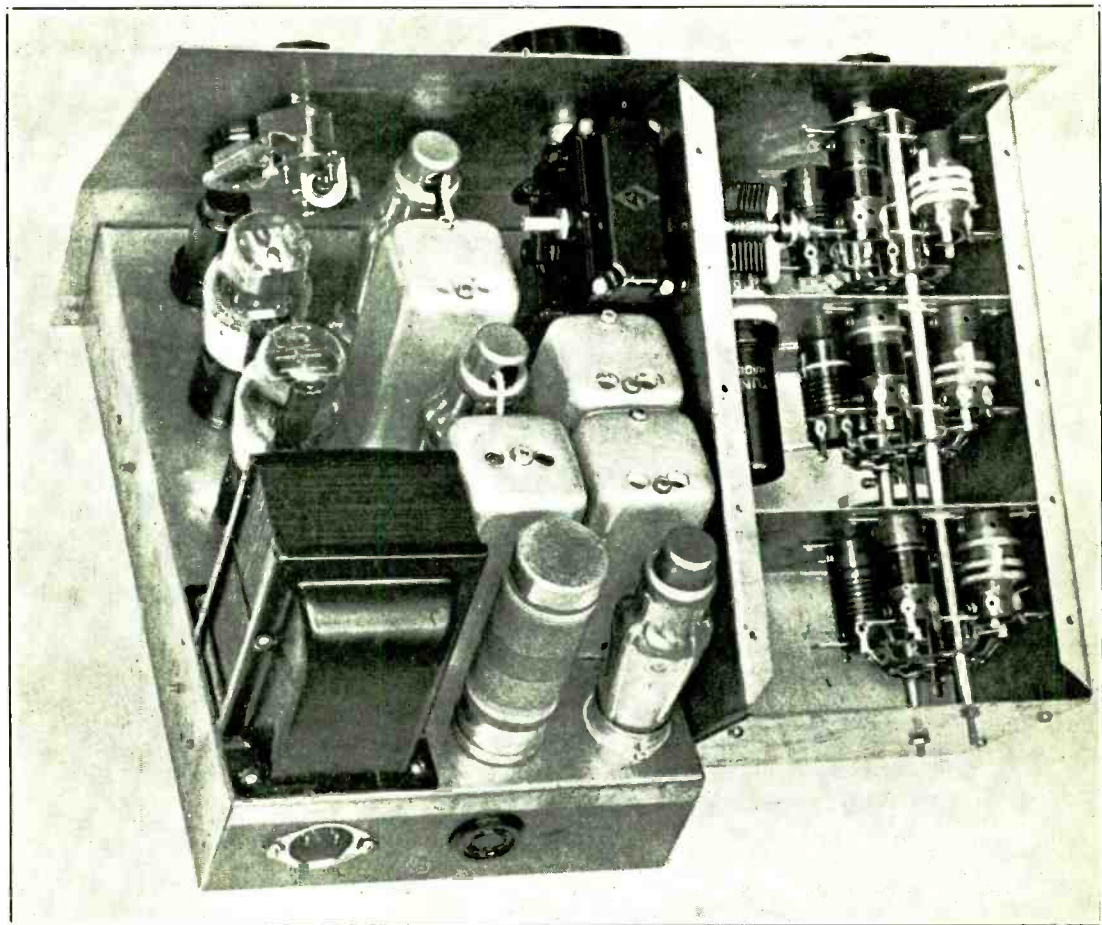

Top View of the Receiver. Top of Coil Assembly Shield Box Removed.

In addition to this, the new tubes on the market permit oscillator coupling with a minimum of "pulling" or interlocking and a maximum of stability.

Preselection

One question which presents itself is that of preselection ahead of the first detector. Some engineers advocate the use of two or more stages of radio frequency amplification and many fellows have successfully used Frank C. Jones' Super-Gainer, embodying no preselection whatsoever. However, in the design of this receiver it was felt that one stage would nicely compromise between too much mechanical complication and too little selectivity and image rejection.

Controls

The idea of ganging the oscillator, detector, and r.f. tuning controls was abandoned at the

outset for two reasons: first because it obviated the necessity for padding condensers and other tracking devices, and also because the r.f. and detector (ganged) could be set with an uncalibrated knob for each band. This could be done by ear and left until the oscillator frequency was moved too far away. This reduced the tuning controls to a large vernier dial for the oscillator, a plain knob for the r.f. and detector, and the band-switch for changing the frequency range. A flexible coupling should be used between the r.f. and detector condensers, and a bakelite rod is preferred for the shaft through the panel to prevent scratching noises. The decks for the band-switch should be of the type employing a flat strip rather than a round shaft, since the band change drive must be inserted through the partitions after they are assembled. Obviously, no band switches are available which



will conform to the needs of any individual receiver, but decks from one or more switches may be combined by the use of long threaded brass rods and suitable sections of aluminum tubing cut up at home. It will be noticed from examination of the photographs that the rods for these switches also form the support for the coils. This locates the coils close enough to the switch to make extremely short leads. Notice how all of the r.f. wiring at a given r.f. potential is limited to one can; that is, all of the radio frequency amplifier grid and antenna input circuit is located in the compartment at the back, all of the r.f. plate and detector grid circuits are located in the middle compartment, while the oscillator and detector plate circuits are in the other.

The First Detector

The first detector tube is a 6A8, since the 6L7 does not seem to develop sufficient voltage across the 50,000 ohm resistor in the injector grid to secure maximum conversion efficiency. This is not of great importance on middle frequencies, but at ten meters approximately ten volts of oscillator input signal is needed, and a husky oscillator is required to draw enough current through the 50,000 ohm resistor to produce this voltage. An electron-coupled 6F6 is used as the oscillator. This might seem like a young transmitter in the receiver, and, in fact, should be so treated as regards shielding and isolation, but it is very necessary to produce enough oscillator output voltage to secure the optimum conversion gain from the first detector. The upper and lower limits of oscillator output voltage may be measured across the 50,000 ohm resistor and should be between 5 and 25 volts (100 to 500 microamperes). These values will give from 300 to 500 micromhos conductance with a maximum at 400 microamperes of about 515 micromhos. The values of oscillator plate resistor and screen voltage should be so selected that the maximum oscillator output will fall below the value given, since too much oscillator signal is fully as detrimental as too little. The overabundance of oscillator voltage will of course occur at the lower frequencies. The leads from band-switches and condensers to the coils should be no. 14 solid wire, air supported, to minimize dielectric losses and frequency modulation due to mechanical vibration.

The I.f. Amplifier

As for the intermediate-frequency amplifier, there was a selection of several types of coup-

ling and tube set-ups, but it was decided that two stages of metal tubes, with one iron-core transformer between them and two link-coupled air-core transformers between the first detector plate and the first i.f. grid, would give the maximum selectivity desirable for phone and the maximum amplification readily obtainable without oscillation. In passing, it might be said that the majority of gain in the superheterodyne receiver comes from the intermediate section, but in addition, a great deal of the noise also arises from the tubes in these stages, especially if there is any tendency towards oscillation.

A well-designed super with the grid of the first detector grounded should produce no more than a faint hiss with the controls wide open, and certainly not the loud roar which greets you from many receivers. Obviously, the fewer tubes used, the less noise there will be. In fact, if it is desired to reduce the expense, the receiver could be built with only one stage of intermediate amplification. In this case iron-core transformers should be used throughout, in the link-coupled stage as well as the other.

Iron-core transformers could also be used in the two i.f. stage receiver if the type which provides two degrees of selectivity were used, in order that the extreme selectivity of the link-coupled system would not impair the audio quality. In any case, great care must be taken in the design of the intermediate amplifier to prevent oscillation. Each stage must be isolated with grid and plate filters, and these filters must be returned to cathode, not ground, so that any i.f. voltage developed across the cathode resistor will then be out of the circuit, and will not result in feed-back and subsequent oscillation. Too many precautions cannot be taken to prevent oscillation. The grid and plate filters for each stage should be located in the shield can of the transformer which they filter. Plate and grid leads should be shielded and the shielding extended well up inside the can. The grounds for each stage should be returned to a common point without relying on the chassis. The mechanical layout of the intermediate system should be such that direct coupling between the grids where they are exposed above the chassis will be minimized. The leads which return the grid and plate filters to cathode should be carefully shielded, and, of course, the cathode returns must not be confused; that is, the grid filter condenser for any particular stage should be returned to its own cathode.

In locating the filter parts in the shields with

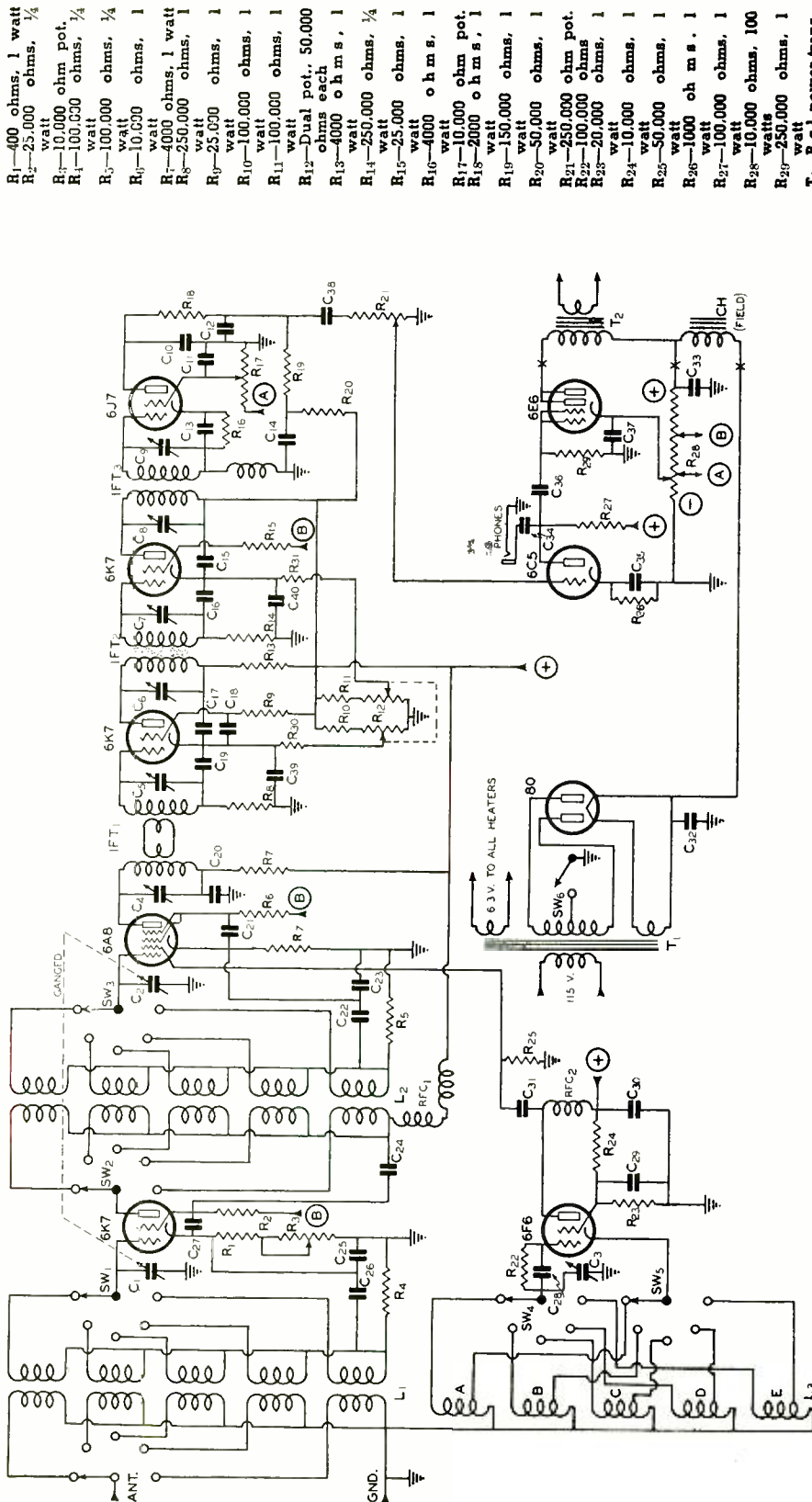

The home-made coil-switching superheterodyne in its simplest version. The c.w. man will want to stick in a beat oscillator, and possibly a crystal filter. These circuits are conventional; hence are not shown. Some phone men will want to incorporate a.v.c. Because of the filtering network already in the grid circuits, the latter is a simple matter (just "lift" the grounds and tie to a.v.c. bus). Control of the r.f. stage and one i.f. stage will be sufficient. A 6H6 is a convenient means of developing a.v.c. voltage.

- C₁—100 μfd. mica each, ganged
- C₂—100 μfd.
- C₃—0.5 μfd. tubular
- C₄—0.5 μfd. tubular
- C₅—C₁₀, C₇, C₈, C₂₁—0.06 μfd. mica
- C₆—C₁, C₇, C₈, C₉—i. f. t. trimmers, integral with corresponding i. f. t.
- C₁₀—0.01 μfd. mica
- C₁₁—0.01 μfd. tubular
- C₁₂—100 μfd. mica
- C₁₃—0.5 μfd. tubular
- C₁₄—0.5 μfd. tubular
- C₁₅ to C₂₀—0.1 μfd. mica
- C₂₁—0.06 μfd. mica
- C₂₂—0.06 μfd. mica
- C₂₃—0.1 μfd. tubular
- C₂₄—0.06 μfd. mica
- C₂₅—0.01 μfd. tubular
- C₂₆—0.06 μfd. mica
- C₂₇—0.06 μfd. mica
- C₂₈—100 μfd. mica
- C₂₉—0.06 μfd. mica
- C₃₀—0.1 μfd. tubular
- C₃₁—50 μfd. mica
- C₃₂—8 μfd. electro.
- C₃₃—8 μfd. electro.
- C₃₄—0.5 μfd. tubular
- C₃₅—10 μfd. tubular
- C₃₆—0.1 μfd. mica
- C₃₇—0.1 μfd. mica
- C₃₈—0.1 μfd. mica
- C₃₉—0.1 μfd. mica
- C₄₀—0.1 μfd. mica
- C₄₁—0.1 μfd. mica
- C₄₂—0.1 μfd. mica
- C₄₃—0.1 μfd. mica
- C₄₄—0.1 μfd. mica
- C₄₅—0.1 μfd. mica
- C₄₆—0.1 μfd. mica
- C₄₇—0.1 μfd. mica
- C₄₈—0.1 μfd. mica
- C₄₉—0.1 μfd. mica
- C₅₀—0.1 μfd. mica

- R₁—400 ohms, 1 watt
- R₂—25,000 ohms, 1/4 watt
- R₃—10,000 ohm pot.
- R₄—100,000 ohms, 1/4 watt
- R₅—100,000 ohms, 1/4 watt
- R₆—10,000 ohms, 1 watt
- R₇—400 ohms, 1 watt
- R₈—250,000 ohms, 1 watt
- R₉—25,000 ohms, 1 watt
- R₁₀—100,000 ohms, 1 watt
- R₁₁—100,000 ohms, 1 watt
- R₁₂—Dual pot., 50,000 ohms each
- R₁₃—4000 ohms, 1 watt
- R₁₄—250,000 ohms, 1/4 watt
- R₁₅—25,000 ohms, 1 watt
- R₁₆—4000 ohms, 1 watt
- R₁₇—10,000 ohm pot.
- R₁₈—2000 ohms, 1 watt
- R₁₉—150,000 ohms, 1 watt
- R₂₀—50,000 ohms, 1 watt
- R₂₁—250,000 ohm pot.
- R₂₂—100,000 ohms, 1 watt
- R₂₃—20,000 ohms, 1 watt
- R₂₄—10,000 ohms, 1 watt
- R₂₅—50,000 ohms, 1 watt
- R₂₆—1000 ohms, 1 watt
- R₂₇—100,000 ohms, 1 watt
- R₂₈—10,000 ohms, 100 watts
- R₂₉—250,000 ohms, 1 watt
- T₁—B. c. l. power transformer, 325 v each side, 115 v, 85 ma.
- T₂—CH—Field and output transformer of speaker
- IFT₁—i. f. t. coupled i. f. (see text)
- IFT₂—Iron core i. f. t.
- IFT₃—Iron core i. f. t.
- H. f. coils are Miller "Select Ur Band"

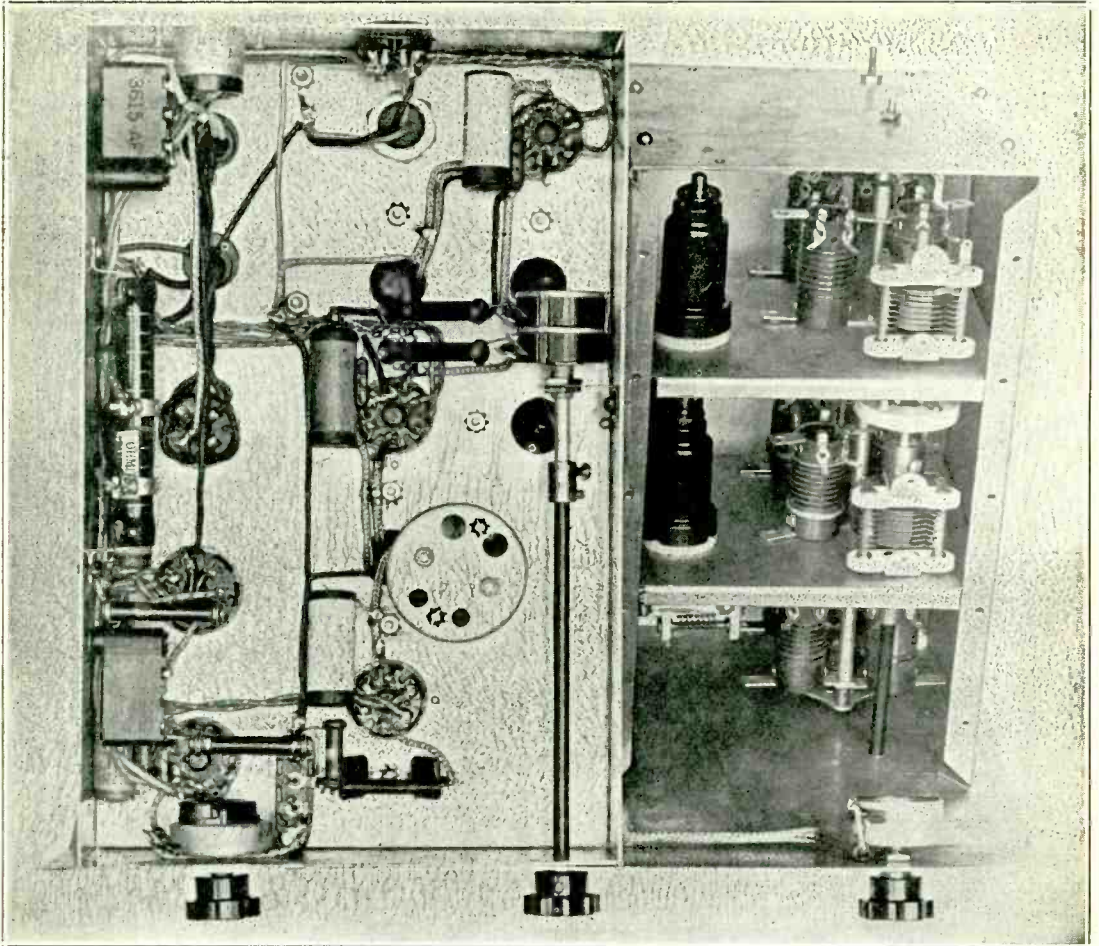

Under Chassis View of the Receiver. Note the Careful Shielding of Leads.

the transformers, the important thing to bear in mind is that the grid of any given stage, as well as the plate of the preceding stage, must be isolated as far as possible, both mechanically and electrically, from its own plate circuit. It may be necessary to use larger cans to accommodate the filter resistors and condensers.

The screen by-pass should, of course, return to the cathode. Another thing to remember is that the reactance of the grid and plate blocking condensers should be low with respect to the grid and plate filter resistors, preferably one-thousand-to-one or more. This makes the path through the pass much easier than that back through the power supply.

The cathode gain controls, if used, should be separate for each individual stage in order that no voltage will be developed across a re-

sistor common to both stages. The reason for this is that, if a change in the plate current of i.f. stage no. 2 occurs, a voltage will be developed across the common cathode resistor which will in turn be coupled through the plate of the i.f. stage no. 1 and the transformer back to the grid of i.f. stage no. 2 and give rise to oscillation. Examination of the circuit diagram will show 25,000-ohm resistors supplying the screen voltage to each i.f. tube. These serve two purposes: first, to filter the voltage for intermediate frequencies, and second, to aid in controlling the volume when manual volume control is used. If it is desired to use a.v.c. exclusively, the size of these resistors should be reduced to approximately 5,000 ohms.

The Second Detector

The second detector may take a variety of

[Continued on Page 178]

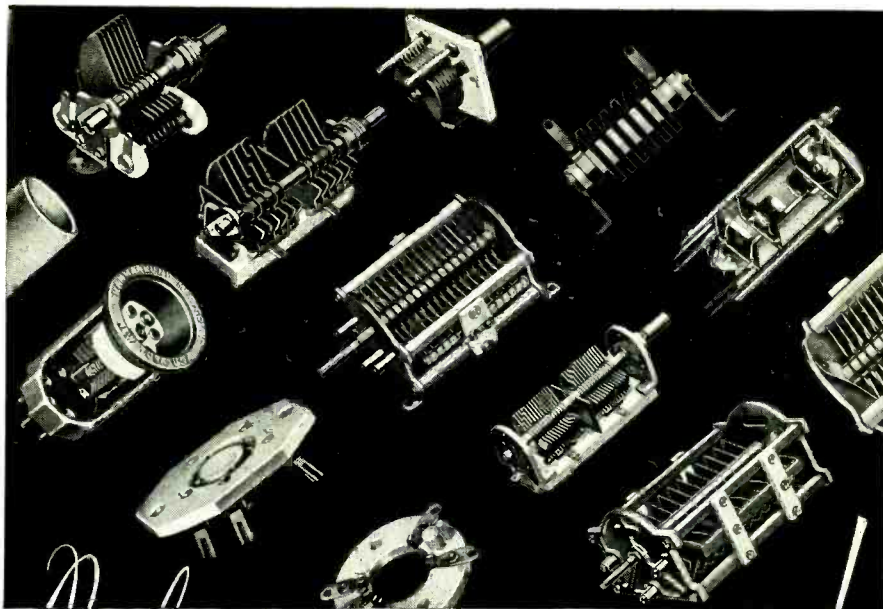

Priceless PRECISION IN EVERY UNIT!

TWENTY-FIVE years ago, the first HAMMARLUND precision products made their appearance to the applause of the radio engineering world. Their dominant superiority promptly became a by-word in laboratories, industrial plants, homes and schools the world over. Today, specialists show an even greater approval of the distinctive and exclusive line of HAMMARLUND parts with *priceless precision built into every unit!* They are specified in every conceivable type of radio instrument.

Every HAMMARLUND product is designed for peak electrical and mechanical efficiency. Wide capacity ratios; vibration proof construction; noise-free operation; quality insulation; selected metals—all with an eye to dependable trouble-free long-lasting service.

A wide variety of stock models is available. Above are shown a few popular HAMMARLUND products—single and split stator mid-geet and micro condensers, transmitting condensers for low and high power, acorn and standard Isolantite sockets, transmitting chokes, Isolantite coil forms, XP-53

plug-in coils, and air-tuned I.F. transformers.

For the professional and advanced amateur, HAMMARLUND also produces the famous "Super Pro" 16 tube superheterodyne receiver. "Super Pro" design, construction and efficiency is distinctively superior. Like all HAMMARLUND products, it has been acclaimed by critical authorities the world over.

The Twenty-Fifth Year HAMMARLUND "37" Catalog, completely describing all HAMMARLUND products, including the "Super Pro", with numerous illustrations, curves, and mechanical drawings, has just been released. A copy will be rushed to you, free of charge, upon request. Just mail coupon below.

MAIL COUPON NOW!

HAMMARLUND MFG. CO., INC.
424-438 W. 33 St., N.Y. City
Please send me the new
HAMMARLUND "37" Catalog



Name
Address
City State R-12-36

HAMMARLUND'S 25TH YEAR



DON'T WAKE UP the WHOLE HOUSE

Just because you are INTENT on getting some distant foreign station LATE AT NIGHT... use

CANNONBALL HEADSETS

and YOU WILL RECEIVE BETTER RESULTS and THE FAMILY WILL NOT BE DISTURBED.

Order from your dealer. If he cannot supply you, we will.

WRITE FOR ILLUSTRATED CIRCULAR L-3

C. F. CANNON COMPANY
SPRINGWATER, N. Y.

Now - a high-powered -



NEW

The Library now comprises a revised selection of books culled from latest McGraw-Hill publications in the radio field.

Radio Engineering Library

—especially selected by radio specialists of McGraw-Hill publications

—to give most complete, dependable coverage of facts needed by all whose fields are grounded on radio fundamentals

—available at a special price and terms.

These books cover circuit phenomena, tube theory net-works, measurements, and other subjects—give specialized treatments of all fields of practical design and application. They are books of recognized position in the literature—books you will refer to and be referred to often. If you are practical designer, researcher or engineer in any field based on radio, you want these books for the help they give in hundreds of problems throughout the whole field of radio engineering.

5 volumes, 3064 pages, 2000 illustrations

1. Glasgow's PRINCIPLES OF RADIO ENGINEERING
2. Terman's MEASUREMENTS IN RADIO ENGINEERING
3. Chaffee's THEORY OF THERMIONIC VACUUM TUBES
4. Hund's PHENOMENA IN HIGH-FREQUENCY SYSTEMS
5. Henny's RADIO ENGINEERING HANDBOOK

10 days' examination. Special price. Monthly payments. \$25.00 worth of books cost you only \$23.50 under this offer. Add these standard works to your library now; pay small monthly installments, while you use the books.

SEND THIS ON-APPROVAL COUPON

McGraw-Hill Book Co., Inc., 330 W. 42nd St., N.Y.C.

Send me Radio Engineering Library, 5 vols., for 10 days' examination on approval. In 10 days I will send \$2.50, plus few cents postage, and \$3.00 monthly till \$23.50 is paid, or return books postpaid. (We pay postage on orders accompanied by remittance of first installments.)

Name.....

Address.....

City and State.....

Position.....

Company..... R. 1-37

(Books sent on approval in U. S. and Canada only.)

The Bias Problem

[Continued from Page 25]

at all critical, a small b.c.l. power pack (putting out, say, 250 volts, which would give us 4/5 of this, or about 200 volts of bias) would be satisfactory. Then, since our total bias should be about 600 volts for phone, we can make up the balance, 400 volts, by means of a grid leak. At 80 ma. of grid current, by Ohm's Law, the resistor should be 5,000 ohms.

Any similar case can be treated in a like manner. After carefully considering the requirements it is not at all difficult to design an efficient biasing arrangement.

Classification 3 includes mainly class B r.f. amplifiers designed for maximum power gain (not the "linear" phone type). The pentodes and, as a matter of fact, almost any other type of tube when operating at maximum power gain (not plate circuit efficiency, but maximum excitation to output efficiency) works best at a fixed voltage of slightly over cut-off bias. The actual value varies with the amount of excitation available, but is usually from slightly under to about 1.5 times cut-off.

Any of the fixed bias arrangements previously given will be satisfactory. Perhaps the best is that shown in figure 3, with the resistor R₁ removed. The same power supply, with other regulator tubes, can be used to supply the bias for the balance of the rig.

If 90 or 180 volts happens to be a convenient value, an 874 or two can be connected in series

110 VOLTS A. C. ANYWHERE

WITH A KATOLIGHT, JR.

Complete Power Plants \$49.95 up.

Operate YOUR radio transmitter ANYWHERE. ANY TIME! — with a Katolight, Jr. Compact, fully portable, efficient, economical. Furnishes standard 110-volt, 60-cycle A. C. Generator filtered and engine ignition shielded. Also converters, generators and A. C. and D. C. plants up to 10,000 watts. KATOLIGHT, JUNIOR

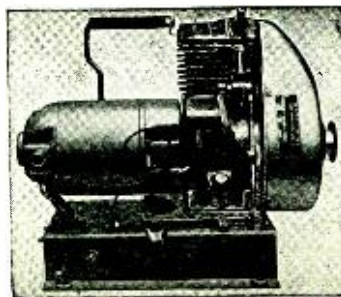

- 6 volt charger, 150 w.....\$49.95
- 12 volt charger, 200 w.....\$59.95
- 32 v., 300 w., battery ign. \$65.00
- 32 v., 300 w., mag-neto ign. \$72.00
- 110 v., 300 watt, rope-cranking, A. C.....\$87.50
- 110 v., 350 watt, self-cranking, A. C.....\$98.00

KATO
Engineering Co.
Mankato, Minn.
U. S. A.

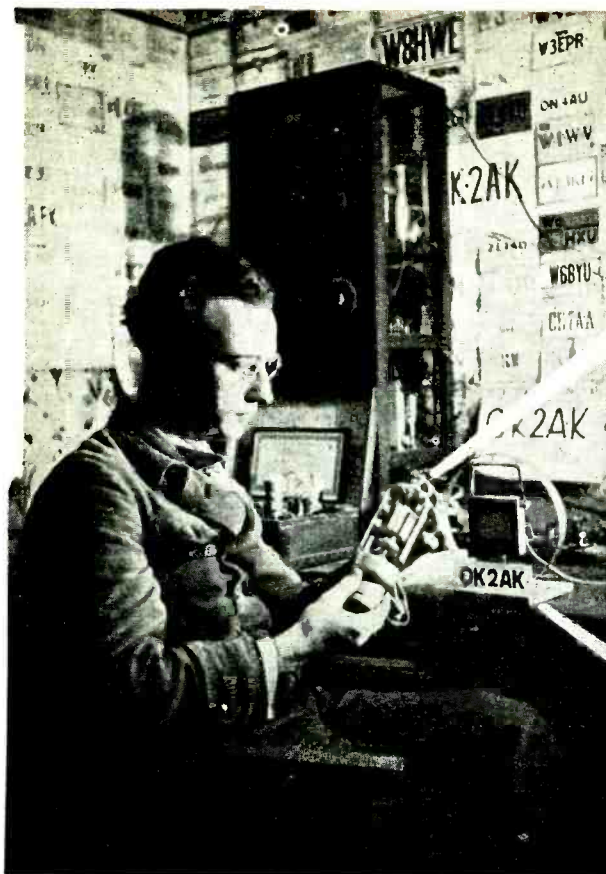

OK2AK

GAMMATRONS WIN ON BOTH SIDES OF THE WATER!

Hans Plisch, OK2AK, winner of W/VE...DX contest for Czechoslovakia with 46,560 points.

A new 20-page brochure is now available containing data for the latest Type 154 Gammatron as well as a revision of the Type 354 Gammatron literature. Request the new Catalog 5357.



For your transmitter!

SQUARE OR ROUND ANTENNA METERS



Use these good looking instruments for measuring the output of your transmitter. The movements are of the rugged hot-wire type and are not affected by frequency changes. You will like these meters because they are built for service and the prices are easy on your pocket book. The round style No. 576 comes in a 3 1/4" flush bakelite case and the square one No. 577 is supplied in a semi-flush bakelite case 4 1/4" square. Ranges furnished are: 0/1.5; 0/3; 0/5 amps. Milliammeters to match, both square and round types are available. Ask for these modern meters at your jobber's or check the handy coupon below.

Gentlemen:

- Send me full information about the Hoyt R. F. Antenna Meters.
- Send me catalog RM-3 with information about the complete line of Hoyt Radio Meters.

Name _____ Street _____

City _____ State _____

THE BURTON-ROGERS COMPANY

SALES DIVISION OF THE HOYT ELECTRICAL INSTRUMENT WORKS
755 BOYLSTON STREET BOSTON, MASS.

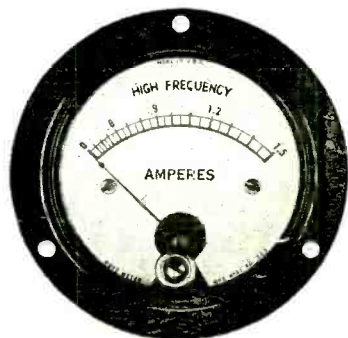

LARGEST EXCLUSIVE AMATEUR SUPPLY HOUSE IN THE WORLD!

Our NEW 120 page CATALOG devoted EXCLUSIVELY to SHORT WAVE, AMATEUR, and COMMUNICATION EQUIPMENT is NOW READY for YOU.

Write for your copy today. It is the "RED BOOK" of AMATEUR RADIO. See our ad on page 178.

MID-WEST RADIO MART
520 South State Street
Chicago, Ill.



"Speech Range" Model D-104 Crystal Microphone

The favorite of amateurs all over the world because of its superior quality in the "speech range," its high output level, its ruggedness of construction, absence from background noise and trouble-free dependability. Bronze case heavily chrome plated. List Price \$22.50. Available with handle, handle with hand switch, handle with relay switch or stand—slightly extra. Equipped eight feet of rubber covered cable.



Under
Constant
Engineering
Improvement

GUARANTEED
Licensed under
Brush Development
Co. Patents

ASTATIC

SEE YOUR JOBBER
ASTATIC MICROPHONE LABORATORY, INC.
YOUNGSTOWN, OHIO, U.S.A.

with the grid return. It is best to by-pass them with an 8 or 4 μ fd. paper condenser. Under limited conditions, less than 50 ma. grid current, this arrangement works well.

Under classification 4 come class B "linears" for phone operation and, although not an r.f. amplifier, the class B modulator. Both of these systems have the characteristic that the grid current varies widely during the modulation cycle. Batteries, storage if available, are best for this type of operation (where the grid current is small and varies over wide limits). However, in an all-a.c.-operated rig and where batteries are undesirable, the hookup shown in figure 3 is satisfactory. The condenser C_1 helps to filter further the power supply and also helps to smooth out small variations in grid voltage that may be caused by the rapidly varying grid current. It may be wise to stress again that the bias voltage, using this arrangement, cannot be measured with an ordinary voltmeter. Measurement may be made with a vacuum tube voltmeter or by the method described before in connection with this type of bias supply.

Push-Push 6L6 Exciter

[Continued from Page 22]

Although it is not necessary except for the grid circuit of the 6L6's, all coils are center-tapped in order that they may be used for other experimental work, without the necessity of making new coils.

The coils are so made that it is easy to change the number of turns if necessary. This is done by using a piece of no. 14 wire to make connection with the prongs and bringing this wire out on the side of the coil. It is not at all difficult to solder the wire used for winding the coil to these "terminals". In other words, for a center-tapped coil there are three such wires brought out to the side of the coil to be used as terminals for the winding.

The link is composed of one turn of solid hook-up wire wound over a $\frac{1}{2}$ inch-wide strip of pyralin, similar to that used on side curtains of automobiles. Pyralin can be obtained at any auto top shop.

By using rubber bands to hold the pyralin strip and cementing the turn of wire to the strip, it is possible to slip the link up or down on the coil to get the proper amount of coupling. After this has been done, it is then neces-

SOLVE YOUR FINAL STAGE PROBLEM BY USING THE NEW

VARI-COIL

Pat. app. for

A low-loss, low-C type transmitting coil whose inductive value can be varied. Tank condenser capacity remains fixed, tuning being accomplished by varying the inductance of the coil! Eliminates expensive high-voltage variable condenser! Condenser can be home made—at a fraction of cost! Send dime for booklet, "How to Solve your Final Stage Problem". Gives constructional details, diagrams and information.

COAST COIL CO., Costa Mesa, California

EIMAC

Transmitting Tubes

A TRIBUTE TO CREATIVE GENIUS



EIMAC 35T
Actual Size

The EIMAC tube is not "just another tube." Engineers who definitely understand **YOUR** problem have developed the finest tubes that it is humanly possible to produce to fit **YOUR** particular requirements. The subtle refinements in design and manufacturing technique that is incorporated in each EIMAC tube means the difference between mediocre and sparkling performance.

As a further tribute to the farsightedness of the founders of the EIMAC organization we note the swing of the entire industry to the use of tantalum for the fabrication of the electrodes for vacuum tubes. The founders of the EIMAC organization have pioneered the use of tantalum in transmitting tubes and have manufactured many thousands of tubes during the past eight years using this material. Spotlessly clean tubes plus the unconditional guarantee of freedom from gas caused by accidental overload attests to the effectiveness of the jealously guarded technique in the proper handling of tantalum.

Play Safe . . . Buy EIMAC at Your Leading Dealer.

EITEL-McCULLOUGH CO. Inc.

SAN BRUNO, CALIFORNIA, U. S. A.



Take Your Pick

Because you are building that transmitter for constant, trouble-proof, inexpensive operation over a long period of time, it will pay you to insist on AEROVOX condensers and resistors—those quality engineered products at mass-production prices.



★ OIL-FILLED CONDENSERS

ROUND-CAN TYPE: Oil-impregnated oil-filled paper section. Hermetically sealed. Seepage-proof. High-tension pillar terminals. Reinforced winding prevents plate flutter. 1000, 1500 and 2000 v. 1, 2 and 4 mfd. A remarkable value.

SQUARE-CAN TYPE: Oil-impregnated oil-filled paper section. Rectangular drawn-metal can. Ideal for space-saving condenser banks. No plate flutter. High-tension pillar terminals. 600, 1000, 1500, 2000 and 2500 v. 1, 2 and 4 mfd.

★ HEAVY-DUTY RESISTORS

Ranging from husky 200-watt adjustable wire-wound resistor shown, to tiny 5-watt wire-wound units, and again to convenient carbon and fibre strip units. And they cost less, first and last.

NEW CATALOG: More pages. More items. More choice. Lower prices. Sent on request, together with sample copy of monthly Research Worker.



LEARN CODE

the way you'll be using it

BY SOUND



There is only one way to learn to read code and that is by listening to code. There is only one way to learn to send code and that is by hearing your own sending repeated back to you. With the Master Telex Code Teaching Machine you learn the natural, easy, fascinating way.

Only instrument ever produced which records your sending in visible dots and dashes—then SENDS BACK your own key work at any speed you desire. We furnish complete course, lend you the New All Electric Master Telex, give you personal instruction with a **MONEY BACK GUARANTEE**—all at a surprisingly low cost per month. Write today for **FREE** catalog "DI". No obligation.

TELEPLEX COMPANY

72-76 Cortlandt Street

New York, N. Y.

• 170 •

sary to cement the pyralin strip to the turn of wire nearest its edge to complete the coil. The link connects to the two unused prongs on the coil form.

The link is connected from the coil socket to the phone tip strip or terminal on the rear of the exciter unit, which is connected by a twisted pair to the next unit.

On the space-wound coils where the wire passes over each rib, it is cemented in place with a drop of no. 3 Q-Max Victron cement. This coating substance holds the wire, link, and pyralin strip in place and makes a nice solid coil.

The reader is referred to the coil table on data for the construction of the coils.

Open Forum

[Continued from Page 66]

dispatched by this station, VK2ABC, since March, 1936 (ninety per cent were dx contacts), only 24 cards have been returned to date, which, you must agree, is rather an excellent return—I don't think!

While on the QSL question, I would like to take the opportunity of advising all those stations that have worked me and have not received cards as yet to inquire at their respective QSL bureaus, where they will find their cards awaiting them.

VK2ABC always QSL's at least once to every station worked via QSL bureaus—and only on special occasions by mail direct, as the cost would be somewhat prohibitive.

FREDERICK J. STIRK, VK2ABC,
ex-VK2XV, VK4XV.

28 and 56 Megacycles

[Continued from Page 59]

and on several days W6ITH, W6MFR and other West Coast signals were R7/8 on 'phone.

ZS1H reported on October 21 that conditions were "not so good as a few weeks ago when stations were coming through like 14 Mc.", but from North Africa CN8MQ reports hearing all continents between 12.30 and 13.00 G.m.t. on October 24, and says that VK.

Preferred by All

TRIMM LEADS

with the most complete head set line in the world. Thousands of operators are using Trimm phones because they are assured of a reliable source of supply and service



TRIMM RADIO MFG. CO.
1770 W. Berteau Ave., Chicago
Illinois, U.S.A.

FOOLS GOLD

••• Just as this unfortunate gold miner is doomed to bitter disillusionment, so will the "fools gold" (false economy) of cheap variable condensers, prove to be a "delusion and a snare".

CARDWELL CONDENSERS

INEXPENSIVE IN THE LONG RUN, ARE MORE EFFICIENT AND LAST FOREVER

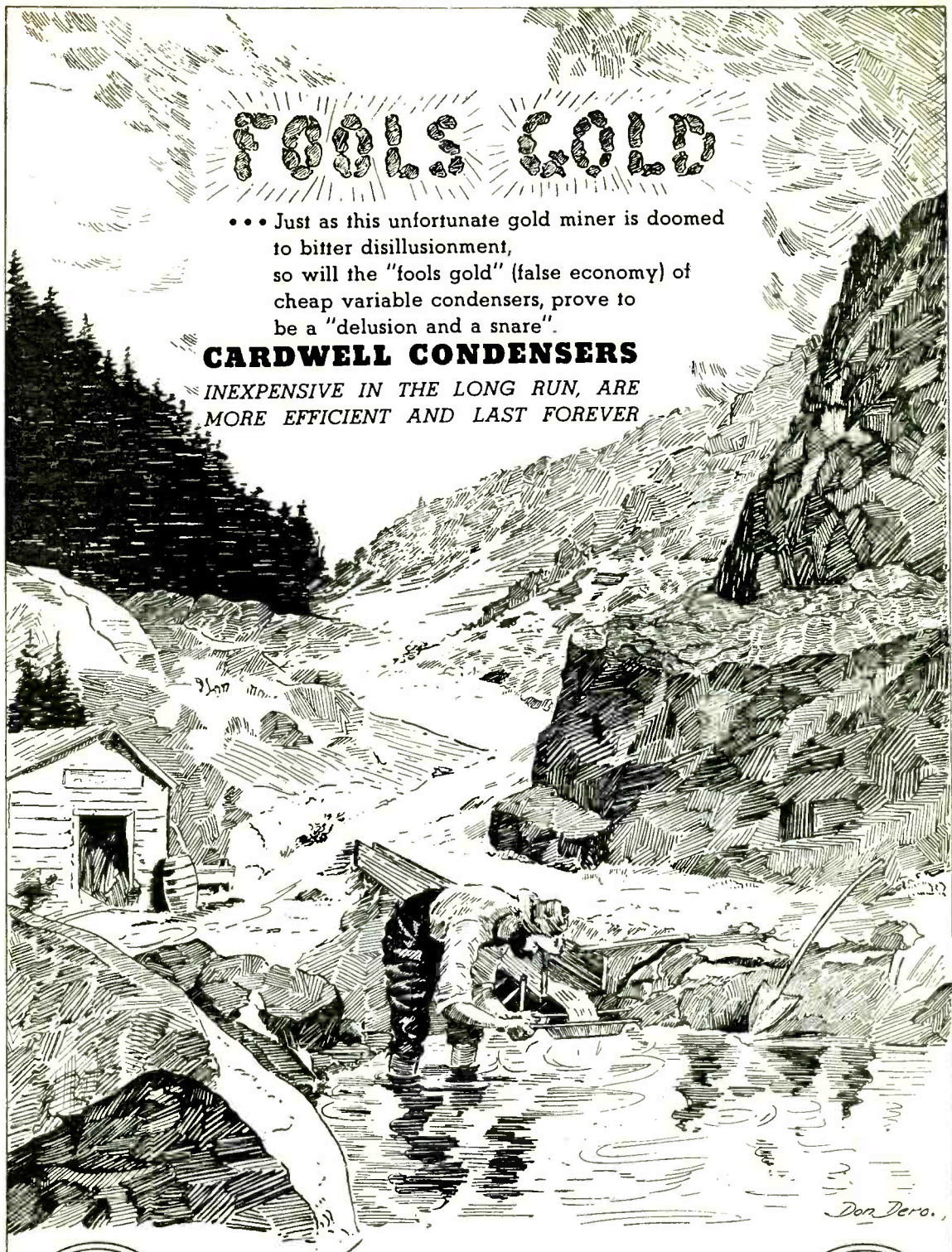

Have you our Handy Amateur Net price bulletin H-7-8, with tabulated data on every condenser an Amateur needs? Your QSL or postcard will bring it, pronto

THE ALLEN D. CARDWELL MFG. CORPORATION

85 PROSPECT STREET, BROOKLYN, N. Y.

I.P.S. RUBBER CRYSTAL FREQUENCY & CHANNEL SELECTOR

**QSY
Remotely
AT
WILL!**

I. P. S.
Rubber Crystal
1 set coils
\$28.50

H. D. Power
Supply in same
type cabinet
\$15.90

Extra coils
per Set \$2.

Link couples
to xmitter
from operator's
desk.



- A complete exciter unit
- 59 or 6L6 model
- Choose your own channel 1 to 100 KC shift on all bands
- Aeroplane dial for band spread
- No quartz crystal used
- High power output Enough to excite pair 210s RK20, 802s, 6L6s, 801s, etc.
- Output on the frequency you wish to work on.
- Eliminates doubler and low power buffer stages
- Plug-in coils for all bands down to 10 meters

SEE IT AT YOUR DEALER

RADIO APPARATUS MFG. CO.
6341 Broadway Chicago, Illinois

ZL, ZS, PY, LU, W6 and 7 are very good at present. The majority of British stations reporting have found conditions excellent on most days, and even QRP transmitters are getting out well. G5CM, using 6 watts to a single 59 in e.c.o., has worked ZS and W3, receiving reports of R8 and R6.

West Coast Americans who have been getting over to Europe well in October are: W6AC, 6BAM, 6BVX, 6EJC, 6FQY, 6FZL, 6GCX, 6GEI, 6GRX, 6ITH (phone), 6JJU, 6JNR, 6JWL, 6KEV, 6KQL, 6MFR (phone), 6PN, 7ABY, 7AMX, 7DSZ, 7DXZ, 7ESN.

VK3CP has recently worked F8VS, G2PL, G2YL, G5RI, G6DH, G6LK, G6WY, HB9AO, OH7ND, OH7NF, OK2OP, and VU2AU.

YL2BB heard all continents in less than an hour on Oct. 25.

G6WN heard all continents on the morning of Oct. 4.

CN8MQ reports VK and ZL audible up to 14.00 G.m.t., South Americans from 08.00 to 18.00 G.m.t., W6 and 7 good between 16.00 and 19.00 G.m.t., and South Africans very consistent.

VE4JV on Oct. 21 said Europe comes in fb, also ZS1H and VK's and ZL's, but Asia very poor. He chased J2IS for "ten" w.a.c. for 2 hours on Oct. 21 but n.d. He was his first J heard on ten.

G6DH is working frantically to try to catch up to ZS1H and VK4EI in the 28 Mc. International Contest which continues to the end of the year.

20 Watt Transmitter

[Continued from Page 28]

grid current with an external 0-10 ma. meter when pruning the coils and first tuning up. After the coils are right and the set is once working, it is no longer necessary to be able to read grid current in order to tune up the transmitter on any band. Merely tune the two tank condensers for maximum antenna power at normal 807 plate current.

The polarity of the pickup turns should be the same as in the diagram; that is, the pickup winding should start at the cold end of the coil and the opposite end of the pickup coil should go to grid. On the two space-wound coils the pickup turns may be wound "between turns". The pickup turns have no apparent detrimental effect when the coils are used as cathode coils. The pickup turns are just left "floating".

7000 Kc XTALS MOUNTED

Hi Activity—Low Drift—Close to Freq.—K-94—Fully Guaranteed—Prompt Shipment. **\$275** p.p.

80-160 M—Mounted \$2.75

80-160 M—Unmounted \$2.00

7000 KC—VERY THICK—K-270—Highly Active

Fully Guaranteed—Mounted \$3.50

Lo Loss Holders \$1.00

Commercial and Police at Attractive Prices—Write

C&S XTALS

836 E. WEBER AVE.

STOCKTON, CALIF.

NEW
BIRNBACH
X'mitting sockets
AT LOW PRICES

featuring

- SIDE WIPING CONTACTS
- BRASS, NICKEL PLATED SHELL
- HIGHLY VITRIFIED, LOW ABSORPTION BASE
- ALL BRASS HARDWARE
- LOW PRICES

No. 434. 50 watt, \$1.25 List ea.
No. 435. 10 watt, 90c List ea.

SPECIAL LOW PRICES IN LARGE QUANTITIES

Improved Cone Standoff Insulators

Made of STEATITE, the better ceramic. Complete range of heights. Condenser, coils, tube sockets, etc., can be mounted with minimum labor. White glaze.

No.	Heights	List	See your jobber. If he cannot supply you, write direct to Dept. RC-1.
430	3/8"	10c	
431	1"	15c	
431J	1"	20c	
432	1 1/2"	20c	
432J	1 1/2"	25c	
433	2 3/4"	25c	
433J	2 3/4"	50c	



BIRNBACH RADIO CO.
145 HUDSON ST. BIRCO NEW YORK, N. Y.

Mr. E. H. Rietzke



President of CREI

● There's Always a BETTER Job for a BETTER Man!

If you're satisfied and content with your present job, you won't be interested in CREI . . . but, if you're ambitious and can see the bright opportunities that lie ahead in Radio for specialized men who have been *Technically Trained* . . . then, CREI can help you as it has helped others out of routine jobs into top positions in the Radio industry.

● "Invest" One Cent Now . . . Write Today for FREE Illustrated Catalog

A penny post card is all you need to request our 48-page illustrated catalog. It contains complete information about our home study and residence courses, as well as easy terms to pay for them. Write today.

CAPITOL RADIO ENGINEERING INSTITUTE

Dept. RA-1
WASHINGTON, D. C. NEW YORK CITY
14th and Park Road 29 Broadway



IT'S IMPOSSIBLE

To Buy a HAM RECEIVER from CHIRAD and be Disappointed.

Ask Us to Tell You Why

TIME PAYMENTS

To Suit Your Convenience

WE HANDLE ALL MAKES OF THE LATEST SHORT WAVE RECEIVERS

LIBERAL TRADE-IN

Allowances on Your Old Receiver

We Have Supplied the Ham with Quality Equipment Since 1921

We Appreciate Your Business

CHICAGO RADIO APPARATUS CO., INC.

415 SOUTH DEARBORN STREET
CHICAGO, ILLINOIS

**NEW-
ECONOMICAL-
GET
120 WATTS
AUDIO POWER**

from push-pull parallel



TUBE COMBINATION

The JEFFERSON laboratory has engineered an amplifier circuit which delivers 120 watts of audio power using the above tube combination.

Development of this circuit was prompted by the success of the JEFFERSON 60 watt P.P. 6L6 amplifier published a few months ago, which, for the first time, made it possible to realize the full output of these tubes.



Plate Transformer
No. 465-261
For 120-Watt Amplifier

Every amateur will be interested to learn how easy and economical it is to construct this amplifier and get 120 watts of audio power.

Send for Bulletin PA-13. JEFFERSON ELECTRIC COMPANY, Bellwood (Suburb of Chicago), Illinois. Canadian Factory: 535 College St., Toronto.

JEFFERSON TRANSFORMERS

Jefferson Electric Company
Bellwood, Illinois

Send full information on circuit and Jefferson Transformers for the 120-watt Audio Power 6L6 Tube combination.

Name

Address

City and State



The RIGHT COMBINATION at your fingertips

HERE'S some light on that SELECTOR SWITCH PROBLEM, you Knight of the soldering iron.

If the circuit calls for more lugs than a centipede has feet scam over to your jobber, and make up your own SELECTOR SWITCH . . . thousands of different combinations possible with a CENTRALAB Kit at his place.

SWITCHES FOR:

- Analyzers
- Output Meters
- R F Oscillators
- Tube Checkers
- Decade Boxes
- A F Oscillators
- Resistance
- Ham Equipment
- P A Work
- Volt-Ohm-Am Meter
- Radio Receiver Replacements
- Capacitance

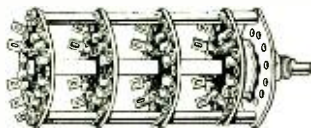

Centralab

Milwaukee, Wis.

British Centralab, Ltd. French Centralab
 Canterbury Rd., Kilburn 118 Avenue Ledru-Rollin
 London N.W.6, England Paris XI, France

The pickup turns should be pruned until about 3 ma. of grid current is obtained under load. The plate and screen voltage to the 807 may be removed while making these preliminary adjustments on the coils. More than 3 ma. of grid current seems to produce no apparent increase in efficiency or improvement in quality. In fact, on the lower frequency bands where it is possible to get considerably more by increasing the pickup turns, it was found that the output actually fell off with more than 5 ma. of grid current.

If it is impossible to hit resonance with the plates of C_3 all the way out on those bands where the plates should resonate nearly out, it either indicates that there are too many pickup turns on the output tank coil or that the leads to C_3 are longer than in the transmitter in the photograph. The cure for the first is obvious. The cure for the second is to remove a half turn (or even a full turn if necessary) from both the 7 and 14 turn exciter coils.

The 807 Amplifier

The 807 should be loaded up to draw from 90 to 95 ma. combined plate and screen current as shown by the meter when plugged into J_5 . The best type coupling is to link the output tank to an external tank or to low-impedance feeders (300 ohm or 72 ohm). The output coil shown in the photograph is a commercially-manufactured product with the link turns built right onto the cold end of the coil. The 5 prong isolantite tube socket that takes the amplifier coils is mounted by means of two angle brackets to the tank condenser. This permits very short leads, improving the efficiency on 10 meters considerably. The 807 tank coils should be wound so that they resonate with the condenser plates fairly well in on 80 and 160 meters, about half way on 40 meters, and fairly well out on 20 and 10 meters. If desired, these coils can also be wound on regular $1\frac{1}{2}$ " forms the same as the exciter coils, but the "air-wound" coils work a little better on 20 and 10 meters, especially the latter.

[Continued on Page 176]



UNIVERSAL VELOCITY AND CARBON MICROPHONES

Universal's latest achievement—Ideal for stage use—Not affected by temperature or humidity—Flat frequency response curve from 40 to 10,000 c.p.s.—Output-63 db; Low impedance or direct to grid types. Compact $2\frac{3}{4} \times 4\frac{3}{4}$ in. by $1\frac{1}{2}$ in. thick—Weight less than 18 oz—Head swings to any desired angle—Beautifully finished in black

enamel and artistic chrome plate—ask for new catalog sheet describing models RL, RP, RH and CB—List \$22.50—Latest model music type sectional stand for above microphones—List \$10.00.

UNIVERSAL MICROPHONE CO., LTD.
 424 Warren Lane Inglewood, Calif., U. S. A.

LET THE CLOCK TICK ON

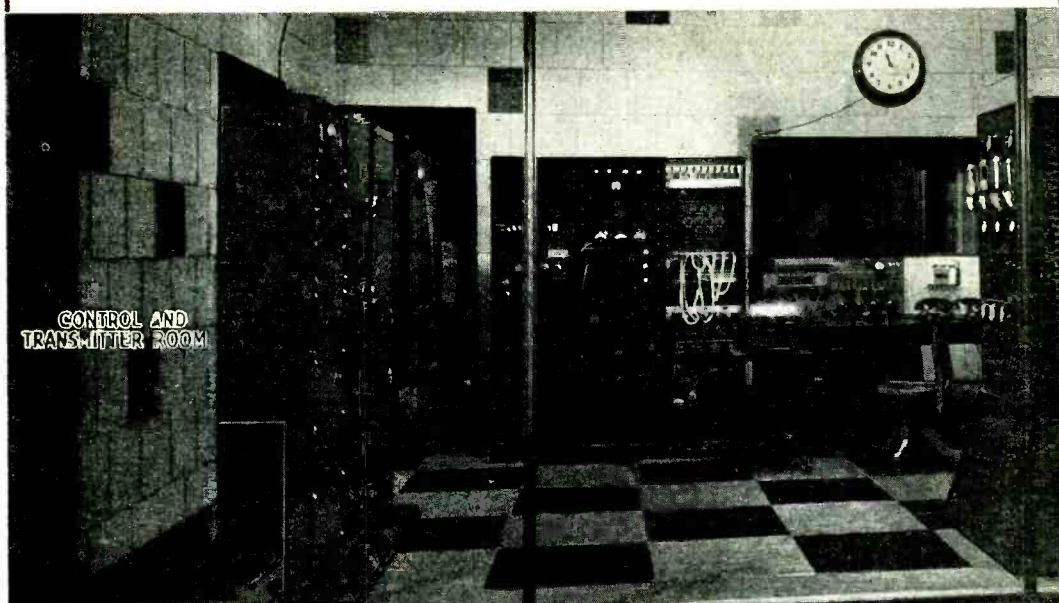

... Sturdy Reliable Transformers by Thordarson Can "TAKE IT"!!

For rugged, efficient transformer service, commercial operators and broadcast engineers insist on "Power by Thordarson" for their commercial and amateur stations. Creative genius, extensive research, precision manufacturing, a square deal sales policy plus the word of mouth or brass pounding testimony of thousands of satisfied users, have gained for Thordarson world wide acclaim. "Power insure" your station for life time service. Equip your rig completely with Thordarson transformers.

"Ask the 'Hams' who own them."



THORDARSON ELECTRIC MFG. CO.
500 W. HURON ST., CHICAGO, ILL.

Demand "Power by Thordarson"

We Offer...

Specialized personal service of genuine value that is not available from other jobbers. Time sales of all receivers and transmitters with terms arranged to suit you and 6% interest charge. Complete stock of all amateur apparatus at net prices. Export orders given individual attention too. All Collins, RCA, RME, Marine, Harvey transmitters at net prices. Trade in your transmitter. Buy on terms.

Trade in Your Receiver and Transmitter

All receivers shipped on ten day trial. You need send but \$5.00 with order, balance C.O.D. These receivers in stock:

The new RME DB-20.....	\$ 39.95
RME-69s complete.....	134.90
The new 1937 Breting 14s complete.....	99.00
RCA ACR-175s complete.....	119.50
Hallicrafters Sky Buddys.....	29.50
Hallicrafters Sky Chiefs.....	44.50
Hallicrafters 1937 Super Skyriders S-11.....	89.50
Hallicrafters Ultra Skyriders S-10.....	99.50
National NC-100s.....	118.10
National NC-100Xs.....	140.60
National HROs.....	167.70

The new 1937 Super Pro (when ready)

The new 1937 Patterson (when ready)

Every order and inquiry is personally attended to by Robert Henry, W9ARA, an active amateur for eleven years; graduate E.E. from M. I. T. and owner of Henry Radio Shop selling amateur supplies for seven years. You can reach me by letter, telegram, phone call, or visit 24 hours a day, 365 days a year. Write for any information.

HENRY RADIO SHOP

211-215 North Main Street BUTLER, MISSOURI

NEOBEAM OSCILLOSCOPE



\$40.00

NET

- Sensitivity--1 microvolt to 200 volts
- Completely self-contained
- 4" Calibrated screen

"Makes Sound Visible"

NEOBEAM utilizes new Neon Beam principle in portraying audio wave form of amplifiers, radios and transmitters. Also used for vibration, sound level and acoustic study.

IT'S MORE THAN AN OSCILLOSCOPE; it's a vacuum tube voltmeter and supersensitive A.C. galvanometer. The calibrated sweep permits direct frequency determination. The 125 db gain 6L6 beam power amplifier permits direct crystal microphone inputs and has speaker output as in a P. A. system, giving both visible and audible perception. Operates direct on all potentials from 1 microvolt to 200 volts. Comes complete, with tubes, ready to operate on 110 v. 60 cycle lines. 8 1/4" x 11" x 13" high. Weight 25 lbs. Finest instrument of its type made—fully guaranteed.

Mail 10c for Instruction Book and Operating Notes.

SUNDT ENGINEERING CO.

Affiliate of Listeluse Laboratories

4236 Lincoln Avenue

Chicago, Illinois

Keying

For several reasons it is not practicable to key the transmitter in the cathode of the 6L6 stage. The cathode is "hot" with r.f., and besides, the 807 pulls a little too much current when the excitation is killed (key up). This is all right for a small period of time, as when tuning up, but is not advisable continuously, as would be the case when the key were left up for very long.

The keying is very clean and free from back-wave when keyed in the cathode of the 807. Throwing the switch SW₁ shorts out the modulation transformer, raising the voltage slightly and removing the keying lag that is present with this winding in the circuit. The cathode of the 807 should not be opened (key plug inserted in the keying jack) until the switch is first thrown to "C.W.". Otherwise the modulators will be working into no load (unless the microphone is removed) and there is danger of blowing the output transformer.

The Rack

The rig was built on a wooden rack with 3/16" Masonite panels and, as can be seen from the photographs, no attempt was made for "dolled up" or commercial appearance. The frame is of "packing box pine". The front view shows two condenser dials at the top, the left one being the oscillator tank dial and the other the amplifier tank dial. The jack in the lower center is for measuring rectified grid current with a separate low reading meter. This is seldom done and so no meter for that purpose was built in, and no provision is made for the cord of the milliammeter on the panel to reach up that far. The lineup at the bottom is as follows, from left to right: microphone jack, key jack, filament switch, plate switch, oscillator plate current jack, modulator plate current jack, phone-c.w. switch, and the last jack reads combined screen and plate current to the 807.

56 Mc. Operation

By inserting 2 turns of no. 10 wire, 1 inch in diameter, into the 807 tank coil socket, the 807 will double to 5 meters. However, the plate runs hot and the output is low (about 3 watts). The tube can be made to run cooler with the same output by inserting another 25,000 ohm resistor in the grid circuit of the 807 (making 50,000 ohms grid leak altogether). This second resistor should be provided with a shorting

T. R. McELROY

WORLD'S CHAMPION RADIO TELEGRAPHER
23 Bayside Street, Boston, Mass.

MAC KEY @ \$7.95 a real speed key.
MAC KEY DELUXE @ \$15.00.
MAC CORD @ \$1.00, speed key cord.
MAC CASE @ \$3.95, speed key case.
MAC OSC @ \$3.95 ac/dc oscillator. Tone control.
If u hv Mac Key wri me fo xmy ipt & dsrb ifn.
All my stuff emcy gad best pduts obl. 73 Mac,

"Radio" for Christmas

AN IDEAL GIFT

RADIO's annual Christmas gift rates will be in effect from November 15th to January 15th. To radio amateurs with a "tellow ham" to remember, to radio employees with a radio-minded employer who must not be forgotten, and to radio manufacturers and distributors who want to remind a favored customer repeatedly through the year of their appreciation of his business, a RADIO subscription is an ideal (and effortless) solution of that puzzling Christmas shopping problem.

ONE SUBSCRIPTION	\$2.50
TWO SUBSCRIPTIONS	4.00
THREE SUBSCRIPTIONS	5.00
ADDITIONAL SUBSCRIPTIONS, each	1.50

These rates apply for the U.S.A., Canada, Newfoundland, Cuba, and Mexico. To other independent American countries and Spain, add 50c per subscription. Elsewhere, add \$1.00 per subscription.

YOU MAY ENTER OR RENEW YOUR OWN SUBSCRIPTION AT THESE RATES

Rates for more than one subscription, as listed above, apply only on gift orders entered and paid for at one time by one individual or company. Unless otherwise requested, the subscriptions will be commenced with the January issue, which will be delivered as near Christmas as possible, together with an attractive card announcing the gift and the sender's greetings; those who are at present subscribers will automatically have subscriptions extended unless otherwise requested.



Announcing!

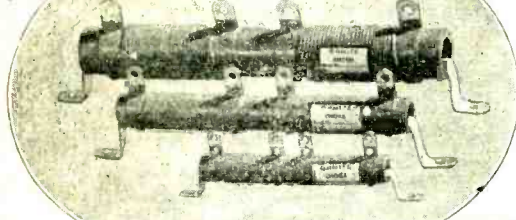

OHMITE POWER LINE CHOKES

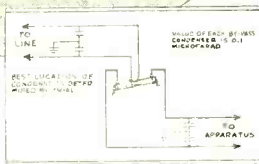

FOR PREVENTING INTERFERENCE FROM HIGH FREQUENCY CURRENTS

★ Again OHMITE is first with the latest! These new solenoid-wound power line chokes score bull's eyes in two directions—first in preventing high frequency currents from going *out* over power lines from radio transmitters, and second, in preventing high frequency currents from coming *in* over power lines to radio receivers. They are not recommended for use in preventing interference of audio frequency.

★ The three Ohmite Power Line Chokes shown in the illustration at the top of this page are designed primarily for amateur transmitter use. The Z-20 Choke, rated at 5 amperes, is designed to take care of low-powered transmitters. The Z-21 Choke is rated at 10 amperes and is recommended for use in medium-powered transmitters. The Z-22 Choke is rated at 20 amperes and is designed for use on high-powered transmitters. For transmitters or other high frequency apparatus drawing more than 20 amperes, special chokes can be made up to specifications.

★ On account of its small size the Z-20 Choke is also specially suitable for use on radio receivers—in preventing interference from nearby high frequency sources from coming *in* to such sets over the power lines. For this reason this choke is particularly desirable to use in working duplex in amateur radio station operation.

★ An Ohmite Power Line Choke and condensers, serving as a filter, is shown in the diagram above. The condensers may be 0.1 microfarad units, rated at approximately twice the line voltage. For further information on these new Ohmite Power Line Chokes see your dealer or send for Bulletin 105.

OHMITE
MANUFACTURING COMPANY
4837 JOURNOY ST. CHICAGO, ILL.
Manufacturers of Resistors and Rheostats of All Types

range, especially in a superheterodyne.

The bias detector seems to be the logical compromise in this case, since fairly good audio quality may be had at the signal levels it is called upon to handle on the amateur bands. The sensitivity is very good and the audio output is higher than either of the other types. If automatic volume control is desired it will be necessary to add another tube, but this may be very simply done by using the amplified a.v.c. with a tube such as the 6B7 or 6B8.

In this particular receiver, which was designed to be used primarily by the builder, it was felt that a regenerative second detector could be used, although it is slightly critical in operation. The oscillating circuit, consisting of the cathode choke and grid coil as well as the bias resistor and bypass which would be likely to radiate an i.f. signal, should be enclosed in a small separate shield (which may be seen in the bottom view near the detector tube socket). Attention should also be called to the plate filter in this stage, which is a very necessary part of the oscillating circuit.

The Audio System

The audio in this receiver may be anything which suits the fancy of the builder. The particular layout shown was chosen because the author likes triodes, and because a pentode would give too much audio gain. The 6E6 is the only six-volt cathode-type triode output tube available with enough output to work a dynamic speaker properly. The audio system definitely should be of the class A type in order not to interfere with the power supply regulation. The bleeder shown is a good investment since it replaces several other resistors in the set, in addition to being a stabilizing load on the power supply. The power transformer, bleeder resistor, output tube, rectifier tube, and all other heat-radiating parts should, without fail, be located away from the oscillator can. The filament wiring should be grounded at the center tap and should not rely on the chassis to carry one side.

Low Wholesale Prices



BIG FREE CATALOG!

Over 10,000 items in this big catalog including radio receivers, nationally known radio parts and broadcasting equipment at low wholesale prices. A catalog of great value to every dealer and serviceman. Write for your FREE copy of this big catalog today.

Burstein-Applebee Co.
1012-14 MCGEE STREET, KANSAS CITY, MO.

NATIONAL COMPANY, INC.



DESIGNERS AND MANUFACTURERS
OF QUALITY RADIO COMMUNICATION
PRODUCTS.

CALIFORNIA SALES REPRESENTATIVE

E. P. DEMAREST

1127 VENICE BLVD., LOS ANGELES

New Edition

LATEST TRANSMITTER DESIGNS

★ Complete specifications for nine tested transmitter circuits, ranging from the smallest beginner's rig to the most elaborate design. Also seven modulators and speech amplifiers with variable output impedances.

★ All circuits include complete specifications, listing transformers, inductances and values of all component parts. It's a complete handbook on transmitter design.

★ Send for it today, the supply is limited. Mail the coupon, your copy will be mailed immediately.

MAIL THIS COUPON

Standard Transformer Corporation
856 Blackhawk Street, Chicago, Ill.

★ I am enclosing 25c for Second Edition Stancor Transmitter Manual.

Name..... Call.....

Address.....

City..... State.....



*Your Jobber
Recommends*



NEWSSTAND READERS . . .

Get our big special annual issue next year
FOR ONLY 20c

by subscribing to "RADIO" for two years (20 issues) at \$4.00!

Or, get it for only 25c by subscribing for one year at \$2.50.

FOR FOREIGN RATES, SEE PAGE 14

Powerful X cut	O. C. L. Control Crystals	High Output
<i>Unconditionally Guaranteed</i>		
7000 KC \pm 5 KC		\$1.85
3500 or 1750 KC \pm 5 KC		1.50
AT CUT 40-80-160 \pm 5 KC		2.25
OMAHA CRYSTAL LABORATORIES		
NORTH PLATTE, NEBR.		
W9JRY	<i>Jobbers Write</i>	W9CPM

A NEW KIND of CATALOG
The "RED BOOK"
of AMATEUR RADIO



**The World's
Most Complete Listing of
AMATEURS' SUPPLIES**

Profusely Illustrated

**Don't Miss These Bargains
in Short Wave, Sound and
Service Equipment**

Write for your free copy

●

MID-WEST RADIO MART
820 SOUTH STATE STREET, CHICAGO, U. S. A.

switch so that it can be cut out on the lower frequency bands. The higher value is desirable only when using the 807 to double.

The output can be increased as follows: Take a small midget condenser of 25 μ fd. capacity (ceramic insulation) and solder across it 4 turns of number 12 enamelled wire, 1 inch in diameter. Solder to the stator a flexible lead about an inch and a half long, with a "grid clip" on the end. To the rotor run a piece of no. 12 enamelled wire long enough to reach the wire that comes up through the baseboard and connects to the rotor of the regular tuning condenser. Solder the end of the number 12 wire to this wire where it comes up through the "floor" (before it goes to the regular tank condenser). For 5 meters, remove the regular grid clip from the plate cap of the tube and connect the one that goes to the midget condenser. When operating on the lower frequencies change the clips and bend the midget condenser and coil assembly back out of the way. The small coil and condenser give approximately twice the 5 meter output (between 5 and 6 watts).

Precautions

The audio interstage (driver) transformer and the mike transformer (especially the latter) should be placed as far as possible from the plate and filament power transformers in order to avoid inductive hum pickup.

One side of the 6L6-G heater should be grounded *right at the socket*, and not several inches away.

Bandswitching Receiver

[Continued from Page 164]

forms: diode, grid-leak, or bias. Either of the latter two types may have regeneration added. The diode type has much greater power handling capabilities, better audio quality, and furnishes automatic volume control voltage quite simply, but has the disadvantage of being less sensitive to weak signals, and also selective due to heavy loading of the i.f. transformer. If diode detection is used, an iron-core transformer should be used here. The grid-leak type is the other extreme, which blocks very easily on strong signals, but is very sensitive to weak signals. However, the average static level is quite frequently high enough to overload this ar-

**A
DIAMOND**

**GETS
RESULTS**



[See Page 186]



**HI FELLERS . . . YOU
WON'T BE ABLE TO RESIST
THESE "WHOLESALE" BUYS**

THE BIG FREE WHOLESALE CATALOG is crammed full of real "buys" in Amateur equipment and accessories. Thousands of "Hams" save beaucoup dollars each year by buying WHOLESALE. Shoot in a postcard with the

coupon pasted to it—get this great radio catalog—and SAVE WITH WHOLESALE. Order from this "ad". Send check or money order now. QUANTITIES LIMITED.

UNPRECEDENTED OFFER

Manufactured by United Transformer Co. New low prices. Ventilated full shields, high tension bushings, universal mounting, with a distinctive silver finish. Type 20462A: Delivers 750/1000 volts a.c. at 300 ma.—RW5475 **\$5.70**
Type 20462B: Delivers 1000/1250/1500 volts a.c. at 300 ma.—RW5476 **\$7.35**
Type 20462C: Delivers 1500/2000/2500 volts a.c. at 300 ma.—RW5477 **\$11.95**
Type 20462D: Delivers 1000/1250/1500 volts a.c. at 500 ma.—RW5478 **\$11.75**

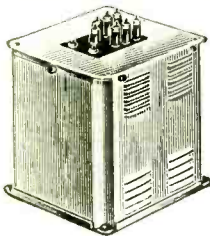

**75% DISCOUNT on
PHILCO
OUTPUT METERS**

For checking output of tuners, amplifiers, etc. Employs "shadowgraph" meter which shows variations in output by a variable width shadow cast on the celluloid screen. Complete with long test leads. Housed in crackle-finished metal case with on-off switch and tip jacks. Ideal for "Hams" and Servicemen. RW10901 List Price \$12.50. **\$2.95**
YOUR COST.....



(The quantity of this item is limited)
NEW NATIONAL NC101X

The newest product of the National Company is the NC 101 X incorporates most of the features of the very highest priced receivers. Automatic Plug-in coils, Permanent Calibration, Micrometer Dial, Amplified delayed A.V.C., C.W. Oscillator, Crystal Filter, Built-in Power Supply. 12 Tubes. Your cost, complete with tubes, crystal filter, 10" dynamic Speaker chassis **\$125.00**

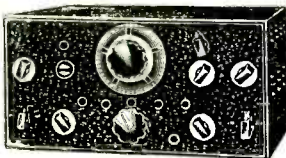

NEW RCA TUBES JUST OUT!

RCA Type 913—A new one-inch low voltage cathode ray tube of the high vacuum, electrostatic deflection type. **\$5.60**
NET PRICE.
RCA Type 808—R.F. Power Amplifier, Class B Modulator. Oscillator, designed to operate at frequencies up to 30 megacycles. **\$10.00**
NET PRICE.



MAIL THIS COUPON

WHOLESALE RADIO SERVICE CO., INC.
CHICAGO, ILL. • NEW YORK, N.Y. • ATLANTA, GA.
901 W. JACKSON BLVD. • 100 514TH AVENUE • 430 W. PEACHTREE ST., N. W.
BRONX, N. Y. • NEWARK, N. J.
542 E. FORDHAM RD. • 219 CENTRAL AVE.

CONDENSER VALUES



0.5 mfd., 1,000 volt Cased Condenser. A high-voltage by-pass condenser suited for use in radio receivers and low powered transmitters. Perfectly sealed and provided with leads. **9c**
RW498 Special Price



1 mfd. 1,000 Volt Cased Condenser. High Voltage paper condenser in metal cans. Mounting centers 5 3/4". Long leads insulated. RW564 Special Price **39c**

SPECIAL CLOSEOUT 2.5 MILLIHENRY CHOKES



Especially suited for use in receivers or low power transmitters. RMY110106. Special price—while they last. **15c**

BAKELITE RIBBED COIL FORMS

Fits all standard sockets. This type of coil offers maximum efficiency because of the air winding that the ribbed construction permits. The six prong type is for the three-winding type of coil.



RW10300—5 Prongs Special **6c Each**
RW10301—6 Prongs

Lafayette 6 VOLT TRANSCPTOR

Now ready, this new 6 volt D.C. model. Incorporates a NEW built-in NOISE FREE powersupply. 8-10w. output in "transmit" position, with more than enough volume for speaker. It's a HONEY—you'll want to know more about this one!

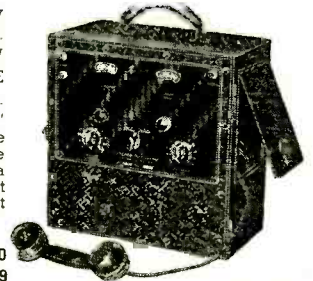

W21075 **\$49.50**
Set of tubes **3.49**

ACT NOW! CLIP THIS COUPON—PASTE IT ON A PENNY POST CARD—MAIL IT RIGHT AWAY!

WHOLESALE RADIO SERVICE CO., INC.
100 Sixth Ave., NEW YORK, N.Y.

Please send Free Radio Catalog No. 65A6.

Enclosed please find \$_____ in Check, Money Order, for mdse. listed on attached sheet.

Name _____

Address _____

City _____ State _____

when
 you want a good frequency meter,

investigate
 the **MICROMETER** Frequency Meter!

Heterodyne-type, a.c. operated, nominal accuracy $\pm .02\%$. Data gladly furnished.

 **LAMPKIN LABORATORIES**
 BRADENTON, FLORIDA

DON'T READ THIS AD

If You are a Millionaire

Now you can get that new equipment on the DEL-RAD "pay as you use" plan. Immediate delivery on all nationally known receivers, transmitters, and parts. You will find our terms more convenient. Be wise and write at once for complete price list and details.

Down Payments as Follows:

National NC 100	\$13.00
National NC 100X	15.50
National HRO	18.45
RME 69	13.00
Breitag 14	11.50
1937 Super Sky rider	10.25
RCA ACR 175	13.15

Liberal time payments on RCA-TAYLOR-EIMAC-RAYTHEON transmitting tubes. RCA-OTTAWA-HARVEY transmitters. Time payments on parts orders over \$25.00 net. Large stock of used equipment at 60% to 75% off original list prices. No time payments outside U.S.A.

Delaware Radio Sales Co.

Willard S. Wilson, W3DQ, Pres.
 405 Delaware Ave.

WILMINGTON, DELAWARE

— Established 1920 —

RELAYS

110 VOLT AC, 60 CYCLE, 30 AMP. CONTACTS IDEAL FOR CONTROLLING YOUR XMITTER

Code No.	Pivot Type with	Shipp. Wt.	Price
1—Single Pole	1 break—1 make	1 pd.	\$1.50
2—Double Pole	2 break—2 make	2 pds.	2.00
3—Triple Pole	3 break—3 make	4 pds.	2.25
4—Four Pole	4 break—4 make	4 pds.	2.50

These relays were used for Laboratory Model work and are in perfect condition throughout. The quantity is limited and subject to prior sale. These prices are about 1/4 of actual cost when new. Send 25% with order, balance C.O.D.

ARROW SALES CORP.

631 WASHINGTON BLVD. CHICAGO, ILLINOIS

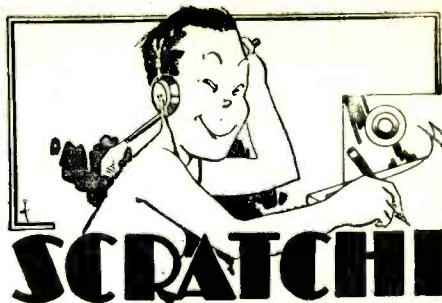

Osockme, Japan.

Radio Magazine

Dear Gentlemen and Ed.—

Everybody here give Scratchi the horsy laff when are getting degree of H.S.E. as mentioned in letter to you last month. It are make me feel very unimportance and insignificance. So I have decide to fool them, hon. ed., by making grate discoveries and inventions. Then when I are famous and Hamafisti from up street come over and say, "You remember me, Scratchi; I are your dear old pal Hamafisti who live up the streets one blocks," I say back to him with scorns and disdane, "I used to knowing fellow by that name I think I recollect, but now that I are become famous I do not have time for knowing such peoples, especials when they are going around giving peoples the hoarse laff, thank you please. It are nice to having know you; good day." Don't you thinking that should putting those scoffer fellows in their place, hon. ed.?

One idea I are working on are new theory for working 5 and 10 meter dx. It are all very deep secret, so please containing same under headgear till I are have time to put my idea to test. You see, hon. ed., it are based on theory that reason many of ultra high freakancy signals do not getting bend back to earth from heavy-side layer are acct. because they are having too mch powder and are hitting it too hard, and signals are bore hole right through layer out into space and nowhere places. That were why the Warner Splatter System did not working hon. ed.;

AMATEURS SAY BUD PRODUCTS ARE VERY GOOD AS WELL AS LOW PRICED

Ask your Jobber to show you the item you want next time in "BUD".

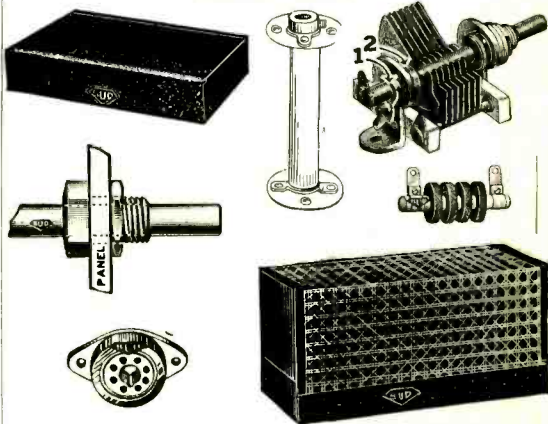

A thirty-two page Catalog FREE will be sent you for the asking.

BUD RADIO INC. 1937 E. 55th St. Cleveland, Ohio

IT'S A HONEY ISN'T IT?
YOU CAN'T BEAT ALLIED
MATCHED KITS WHEN
YOU BUILD YOUR OWN!

YOU'LL ALWAYS FIND ALLIED'S
CATALOG LOADED WITH NEW
GEAR AT THE
LOWEST PRICES!



"You Get Better Service and Save Money at Allied"
SAY AMATEURS AND EXPERIMENTERS EVERYWHERE!

—And thousands of enthusiastic Amateurs and Experimenters can't be wrong! No matter what your radio needs are, the entire ALLIED organization is keyed to meet your requirements:

21 expert Amateurs and Engineers to help you select the equipment you need, accurately and economically—to answer your inquiries quickly, in a helpful personal way!

10,000 selected radio items—the cream of Amateur Radio—tested and approved by trained engineers—to assure you of highest quality always—to give you speedier shipment on every order—to make your radio buying easier and more profitable!

ALLIED's economical merchandising, tremendous purchasing power and efficient shipping methods bring you the finest values in Amateur Radio—quickly and safely—at the lowest prices. You save in time, trouble and money on every purchase when you order from ALLIED—that's why ALLIED is "tops" in Amateur Radio!



TESTING LABORATORY AT ALLIED . . . A corner of our modern, well-equipped laboratory where skilled radio technicians carefully test equipment offered in the ALLIED Catalog for quality and performance. Our high standards are your best protection—your assurance of greatest dependability and value!

EVERYTHING IN RADIO AT LOWEST PRICES

If you haven't a new 1937 ALLIED Catalog write now for your FREE copy! It includes more than 10,000 duplicate and replacement parts; 38 models of the new Knight Radios; dozens of Build-Your-Own kits; the latest SW receivers and transmitters; P.A. Equipment; test instruments; Rurlpower units and Windchargers; books, tools, etc. Send for this great book today!

**FREE
CATALOG**



**ALLIED RADIO
CORPORATION**
833 W. JACKSON BLVD., CHICAGO

ALLIED RADIO CORP.
833 W. Jackson Blvd., Chicago, Ill. Dept. 14-A
Rush me your 1937 ALLIED Radio Catalog.

Name

Address

City State

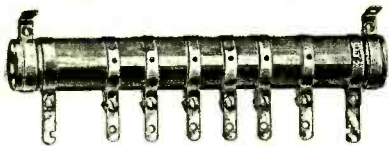

ATLAS PRODUCTS
TOLERANCE 2%
LONG LIFE
ACCURATE
SAFE WATTAGE RATING

Our Diamond Antenna Resistors are used by many prominent amateurs. See your favorite distributor.



ATLAS RESISTOR CO. *Pacific Coast Repr. Don Wallace, W6AM*
 423 BROOME ST., NEW YORK, N.Y. 4214 Country Club Dr.
 WRITE FOR NEW 1937 CATALOG Long Beach, Calif.

★ **Announcing the new PEERLESS**

"100-DX" transmitter. Uses RK-34 oscillator, doubler, RK-20 amplifier. Built in a 3 ft. crackle finish standard relay rack, with steel crackle finish panels, 3 Triplet meters, and new type silver finished dials.

Power rating — 80 watts, C.W. — 35 watts, Phone.

Write for Complete Descriptive Literature and Full Details

RCA 866	\$1.75 each
RCA 807	3.90 each
Taylor 866	1.65 each

Send for complete details on the NEW PEERLESS "20-DX" transmitter. Fine business for an exciter unit. Uses a 53 oscillator doubler and an 802. Completely wired and assembled for CW only, less tubes, and crystal, but with coils for any two bands \$24.75

Write for our trade in allowance on your present receiver towards any of the new communication type receivers, such as National, Hammarlund, Hallicrafter, RCA, RME, etc.
 Featherweight earphones..... \$.89

Used Jewell millimeters, Pattern 53. Ranges 0-100, 0-200, 0-300.....\$2.50 each

Uncle Dave's Radio Shack

356 BROADWAY, ALBANY, N. Y., U. S. A.
 Cable Address "Uncledave"—Foreign Trade Solicited
 Send 20% deposit with c.o.d. orders—Phone 4-5746
 Prices F.O.B. Albany—Send for new HAM CATALOG

they were use too much powders, and signals hit heavy-side layer so hard they went right on throo. It are all very simples when you are not get the idea, hon. ed. The books say that at 28 megacackles the wave will not be return to earth if it hit heavy-side layer at too steep an angles, acct. because it will going right on through. Ah ha, hon. ed., that are proof. By sending out a signal so week it could not having enough powder to penetrate hot butter it would getting bounced off the layer like a rubbers ball.

The advantages of the Scratchi Splashy System are tramendus, and it are take the mind time to comprehend such collosus advantages. For instances: the high powdered man will having no advantages over the low powdered man, in fact he will be at a disadvantage. But it are very simple for him to solve. All he have to do are to lower his powder, and he go up to R9.

If one are not modulate strong enough, all he having to do are to turn down the gain control, and will going up in signal strength at other end.

To prevents amateurs from hogging the hand, will being of necessary to put into effect a "minimum powder law", making against rules to use less than 5 watts. Otherwise would QRP so much that would QRM everybody with such loud signals, and poor fellow with 500 watts would not having of chance on 10 meters.

Only thing that are worry me hon. ed. are problem of back wave on c.w. Station with back wave would be louder with key up than with key down, resultings in slight difficulties in copy. Are working on this problems now, along with "Scratchi Signal Booster", which are clever devise in little box which sell for \$10 in black crackle and which are guarantee to raise signals strength of transmitter on 10 meters. Please keeping dark, hon. ed., but are nothings but fore bit resistor which are connected in series with powder line to plate transformer. Are having some binding posts on box to connect to antenna and also to bias circuit, but are not connect or go anywhere inside the little box. Hee hee haw haw hon. ed., don't you thinking that are slick gadget for making monies? If you wanting to invest in "Scratchi Signals Booster" please remit \$5 by return male and will giving you half interests in promotion of same.

Say, I just explain my Scratchi Splashy System to my brother Itchi who just come in, and he show his ignorance by resnort: "Why not throwing the rig out honorable window and sticking head out same just yell 'Calling CQ please megacackles 28'".

Come to think of it hon. ed. according to my theeries it are not such bad idea at that. Please referring to your technickel staff and information free department.

Respectively yours,

HASHAFISTI SCRATCHI.

NOTHING ELSE LIKE IT!

Devoted entirely to practical transmitter construction; no theory! Complete detailed descriptions, photos, circuits and dimensioned drawings for building phone or CW transmitters from 5 to 500 watts! Xtal oscillators; exciters, power amplifiers, power supplies, modulators and an entirely new keying system using mercury vapor tube!

"Practical Amateur Radio Transmitter Designs"

By HOWARD S. PYLE Formerly Assistant U. S. Radio Inspector

is meeting with immediate popular acceptance by the amateur fraternity. Get your copy today from your nearest good parts dealer or direct from the publishers—

50c POSTPAID
 IN U. S. A. AND
 C A N A D A
 60c ELSEWHERE

Western Technical Press

807—4th Ave., Seattle, Washington

DEALERS—
 WRITE FOR
 T R A D E
 P R I C E S

INCA Transformers

for the hi-power rig

This year INCA has devoted a lot of thought to the development of high-voltage power and audio equipment for kilowatt phone and c.w. rigs.

Plate transformers, chokes, filament transformers, audio transformers; all are available in the high-voltage and heavy current class for the maximum rating jobs. Good examples of these are the B-45, D-46, D-26, J-35, L-34, L-37, N-28.

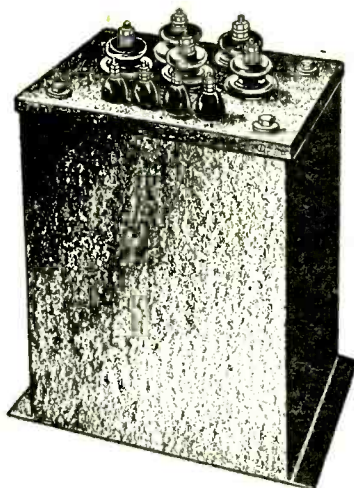

INCA B-45 will deliver 4000, 3500, 3000 volts @ 375 m.a. in bridge; 2000 or 1500 volts @ 750 m.a. in standard full-wave circuit. Primary can be connected for 115 or 230 volts 50-60 cycles, or 115 volts may be connected across 230 volt winding for operation at reduced power. The B-45 is mounted in Case 14, illustrated above, and is really **insulated** for hi-voltage operation.

INCA B-45 — Code ZEJKM..... **List Price \$55.00**

INCA D-46 input swinging choke for 750 m.a. circuits. 40/8 henries @ 75/750 m.a., 60 ohms, insulated for operation @ 4500 volts, Case 14.

INCA D-46 — Code ZEILN..... **List Price \$36.50**

INCA D-26 Smoothing choke for operation in 750 m.a. circuits, operating insulation 4500 volts, 12 henries @ 750 m.a., 54 ohms, Case 14.

INCA D-26 — Code ZEJZB..... **List Price \$34.50**

INCA J-35 Bridge filament transformer for use in 4500 volts circuits. Three filament windings for 4—866's. Primary tapped for 105-110-115-120 volts 50-60 cycles, Case VII (with leads).

INCA J-35 — Code ZEJYA..... **List Price \$12.50**

INCA L-34 Operated from push-pull parallel 2A3's or 6A3's to Class B grids. Will handle 30 watts of audio, secondary tapped for any Class B tubes, Case VI.

INCA L-34 — Code ZEJPS..... **List Price \$10.50**

INCA L-37 Similar to L-34, but operates from 50, 200, 500 ohms to any Class B grids, handles 30 watts audio, Case VI.

INCA L-37 — Code ZEIEC..... **List Price \$10.50**

INCA N-28 Universal Modulation transformer from any Class B tubes (up to 600 watts audio output) to RF stage, carries full RF plate current through secondary. Primary 4000 to 16000 ohms. Secondary 2000 to 20000 ohms, Case 14.

INCA N-28 — Code ZEKCD..... **List Price \$65.00**

All the above, as well as the complete INCA line of transformers, amplifier kits, transmitter kits, and wire, are described in Bulletin L-31, obtainable at your jobbers or from—

The Phelps Dodge Copper Products Corporation
INCA MANUFACTURING DIVISION

2375 East 27th Street

Los Angeles, California



A DIAMOND ...Gets Results!

"You can't beat a diamond" . . . whether it is on the ring finger of her left hand or strung between three apple trees and Brown's chimney. On the hand or on the air, a diamond gets results.

The real "low down" on the theory, operation, and construction of the rhombic antenna may be found in

"THE 'RADIO' ANTENNA HANDBOOK"

The "'Radio' Antenna Handbook" is not just a reprint of various magazine articles. 90% of it has never appeared in any magazine. It was written from start to finish as the only complete book of its kind on antenna theory and practice. It is full of diagrams, tables of lengths for all frequencies, dope on all useful directive arrays, and a complete discussion of noise-reducing receiving antennas. It is chock full of many new and useful wrinkles which are real scoops.

U.S.A. and Canada 50c Elsewhere 60c

At all good radio parts dealers or direct from us by mail, postpaid.

DEALERS: Write for trade prices.

NO STATION IS BETTER THAN ITS ANTENNA

**RADIO, Ltd.,
7460 Beverly Blvd.,
Los Angeles, Calif.**

Please send me copies.

Enclosed find \$ in full payment.

[50c in U.S.A. and Canada (Canadian postal notes acceptable); 2/6 in United Kingdom (British postal notes and cheques on London acceptable at par); elsewhere, 60c, U.S.A. funds.]

No stamps, please, unless other means of remittance are not available.

Name

Address

City and State

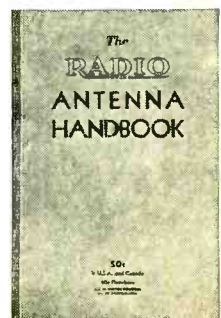

The Marketplace

(a) Commercial rate: 10c per word, cash with order; minimum, \$1.00. Capitals: 13c per word. For consecutive advertising, 15% discount for 3d, 4th, and 5th insertions; 25% thereafter. Break in continuity restores full rate. Copy may be changed often as desired.

(b) Non-commercial rate: 5c per word, cash with order; minimum, 50c. Available only to licensed amateurs not trading for profit; our judgment as to character of advertisement must be accepted as final.

(c) Closing date (for classified forms only): 25th of month; e.g., forms for March issue, published in February, close January 25th.

(d) No display permitted except capitals.

(e) Used, reclaimed, defective, surplus, and like material must be so described.

(f) Ads not relating to radio or radiomen are acceptable but will be grouped separately.

(g) No commissions nor further discounts allowed. No proofs, free copies, nor reprints sent.

(h) Send all Marketplace ads direct to Los Angeles accompanied by remittance in full payable to the order of Radio, Ltd.

(i) We reserve the right to reject part or all of any ad without assigning reasons therefor. Rates and conditions are subject to change without notice.

MODULATOR UNITS as described on page 18 July issue of **RADIO**, less microphone. \$79.50. Dual power supplies on same size chassis, \$75.00. Output transformers are our type A-150-M. A real 150 watt universal output transformer, will match most tubes, 7 impedance ratios. Input and output transformers, \$16.50 per pair. **LANGRICK RADIO ENGINEERING SERVICE**, W6PT, 626 Maltman Avenue, Los Angeles, Calif.

WANTED—FB7 coils. Write W6MYK, Carrier 25, Phoenix, Arizona.

QSL's. 300 one-color cards, \$1.00. Samples. 2143 Indiana Avenue, Columbus, Ohio.

RESPONDING to over 500 requests, we again offer those 95c crystals. Holders, 60c. X-cut forty meters, \$2.00. AT-cut mounted, \$2.35. **WHITE RADIO LABORATORY, SANDPOINT, IDAHO**.

QSL's—SWI's. Sure to **SATISFY**. **FRITZ**, 203 Mason Ave., Joliet, Illinois.

SELL: 1936 Super-Skyrider. 9 metal tubes; crystal; 7 months old; perfect condition; \$55.00. Buying Ultra-Skyrider. 1341 South St. Andrews Pl., Los Angeles.

ACR-136, one year old. Perfect condition. Complete. Best offer accepted. 506 E. Main, Riverhead, N.Y.

PLATE Transformers—Hilet, 2½ kw., 160 lb., guaranteed, \$39. Chokes—30 hy., 180 ohms, 500 ma., 82 lb., \$18; 10 hy., 50 ohms, 500 ma., 42 lb., \$12; 15 hy., 38 ohms, 800 ma., 48 lb., \$15; 20 hy., 65 ohms, 750 ma., 108 lb., \$25; 20 hy., 95 ohms, 500 ma., 73 lb., \$16; 10 hy., 30 ohms, 1000 ma., 75 lb., \$15. Send for circular. Leitch, Park Drive, West Orange, N.J.

CRYSTALS: Eidson "T9" X-cut, dependable, powerful. Ground to resist fracture. Accurately calibrated, close frequency supplied: 40, 80, 160 meters, \$1.50 postpaid, fully guaranteed. Superlapped "T9" ceramic plug-in holders, \$1.10 postpaid. **COD orders OK**. "Eidson's", Temple, Texas.

THE CRYSTAL SHOP specializes in AARS networks. Any commercial frequency supplied. **W1BD**.

1935 AC SW-3, tubes, coils, power supply. \$25 cash. **J. K. Robertson**, 608 North Gardner, Los Angeles.

METER Repair Service. Complete repair and replacement service on all types of meters. Reasonable prices. **Braden & Apple Co.**, 305 Park Dr., Dayton, Ohio.

LEAVING radio, bargain list sent. Transmitter, receivers, transmitter, vibroplex, portable, meters, tubes, power supplies, miscellaneous parts. **Adams**, 1336 Greenleaf, Chicago.

FORCED sale: best fone c.w. transmitter made. Complete for less than cost parts alone. Coils: Bliley crystals and holders for 20, 40, 75, 80, 160 bands. Collins 150B special. Class B, network. Fully metered. Overload underload relays. Steel rack cabinet totally enclosed. Speech amplifier and control panel separate for rack mounting. Complete with all tubes. WAC fone and c.w. Cost over \$900. Guaranteed like new. Beautiful job. First check \$400 FOB El Paso. Write Box 1110.

STEEL shield cans, chassis, panels, racks, cabinets. Send sketch for estimate on your layout. **R. H. Lynch**, 970 Camulos, Los Angeles, Calif.

TRADE highest quality transmitting and receiving equipment, factory-made, for deluxe factory-built auto trailer. Write details to **W5NT**.

BEST quality radio equipment trade for late Contax. Rolliflex. Exacta. Give details and requirements. 405 North Mesa Avenue, El Paso.

SPECIAL 866B's—\$3.75. 866's—\$1.65. Guaranteed six months. **F. B. Condenser** mike heads \$10.00. 100 watt Universal Class "B" transformers \$8.00 pair. **Langrick Radio Engineering Service**. W6PT. 626 Maltman Ave., Los Angeles, Calif.

STAMP brings you sample Radio Data Digest. Keeps posted. Saves money. **Kladag**, Kent, Ohio.

AMATEUR RADIO licenses, complete training. Resident and correspondence courses. Every graduate a licensed operator. **N.Y. Wireless School**, 1123 Broadway, New York.

CASH for SW-3, Class B 203-A Modulator transformers. Name prices. **W6MVK**, N.S. Sue Co. Bldg., Modesto, Calif.

STATIONERY FOR AMATEURS. \$1.25 postpaid brings you 125 note sheets, 5½"x8½", 100 envelopes. Each beautifully printed in rich blue ink with your call letters, name and address on white bond paper. West of Mississippi, 10c additional. **Port Stationery Co.**, Dept. C, Port Chester, N.Y.

CRACKLE-FINISH baked on metal, masonite, and wood panels. Send sizes and kind of material for estimate. **R. H. Lynch**, 970 Camulos, Los Angeles, Calif.

VOLTAGE amplifier and power supply, November **RADIO**, page 18, were built in our type "S" cabinets. Size 7x10x6½". Cabinets, \$2.20 each. 6 pounds. **R. H. Lynch**, 970 Camulos, Los Angeles.

ATTENTION: All crystal grinders. Blanks, all cuts, all sizes, perfect quality, no twinning. **FABERADIO**, Sandwich, Ill.

WANTED: .004 mf.-12,500 Dubilier spark condensers, quenched gap, spark transformer. State price, condition, full particulars. **W6JNE**, 4203 Griffin Avenue, Los Angeles.

TRADE: AC-SW3, tubes, 40-80 coils, power supply and cash for used '35 Super Skyrider. **W6KDR**.

DISTINCTIVE "QSL's—SWL's!". Stamp; samples. **W9UII** Press, 2009 Fremont Street, Chicago.

SUPER-SIGNAL third-harmonic forty-meter crystal going over big. Information on request. **CRYSTAL SHOP**, Barre, Vermont.

WRITE us for trade-in price on your old receiver. We buy meters. **Walter Ashe Radio Co.**, St. Louis, Mo.

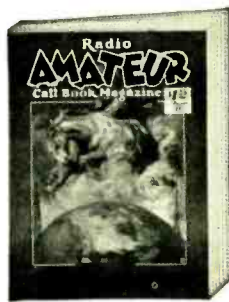

The Most Complete Callbook Ever Published

Your QRA is listed in the latest edition

The only radio callbook published that lists all radio amateur stations throughout the entire World.

Also a complete list of high frequency commercial stations, International abbreviations and amateur prefixes, "Q, R, & T," systems for reporting signals, new US inspection districts and high frequency time, press and weather schedules.

Each copy contains a double post card addressed to the **CALLBOOK** for use in reporting your new QRA. We are extremely anxious to publish a callbook that will be 100% correct and want you to help us by checking your QRA at once in the latest edition and advise us of any errors.

PUBLISHED QUARTERLY MARCH, JUNE, SEPTEMBER AND DECEMBER

Single Copies \$1.25 Annual Subscription USA, \$4.00

Order your copy today from your local radio jobber or direct from:

RADIO AMATEUR CALL BOOK, Inc.
606 South Dearborn Street, Chicago, Illinois



BUYER'S GUIDE

Where to Buy It

CALIFORNIA — Los Angeles

Radio Supply Company
912 So. Broadway

THE AMATEURS' HEADQUARTERS OF
THE WEST

All Nationally Advertised Parts for Receiving
and Transmitting Carried in Stock at All
Times. 9 Licensed Amateurs on Our Staff.

FLORIDA — Jacksonville

GLOVER WEISS CO.
2 E. Bay St., Cor. Main

ILLINOIS — Chicago

CHICAGO RADIO
APPARATUS CO., Inc.

Established 1921

415 SOUTH DEARBORN STREET
(Near Van Buren Street)

ALL SUPPLIES FOR THE SHORT
WAVE FAN AND RADIO AMATEUR
QUOTATIONS FREELY GIVEN ON
ANY KIT OR LAYOUT

Short Wave Receivers Taken in Trade
Get our low prices

MARYLAND—Baltimore

Radio Electric Service Co.
3 North Howard Street
Baltimore, Md.

NEW YORK — Buffalo

DYMAC RADIO
216 E. Genesee St.

TEXAS — Fort Worth

Ft. Worth Radio Supply Co.
104 East 10th St.

INDEX OF ADVERTISERS

Aerovox Corp.....	170
Allied Radio Corp.....	183
Arrow Sales Corp.....	182
Astatic Microphone Lab., Inc.....	168
Atlas Resistor Co.....	184
Birnbach Radio Co., Inc.....	172
Bud Radio, Inc.....	182
Burstein Applebee Co.....	180
Burton-Rogers Co.....	167
C & S Xtals.....	172
C. F. Cannon Co.....	166
Capitol Radio Eng. Institute.....	173
Cardwell Mfg. Co., Allen D.....	171
Centralab.....	174
Chicago Radio Apparatus Co.....	173
Coast Coil Co.....	168
Cornell-Dubilier.....	2
Davega, Inc.....	9
Delaware Radio Sales Co.....	182
Demarest, E. P. (National Co., Inc.).....	177
Eitel McCullough, Inc.....	169
Hammarlund Mfg. Co.....	165
Hallicrafters, Inc., The.....	8
Harvey Radio Co.....	10
Heintz & Kaufman Ltd.....	167
Henry Radio Shop.....	176
Hinds & Edgerton.....	11
Inca (Phelps Dodge Copper Prod. Corp.).....	185
Jefferson Electric Co.....	173
Kato Eng. Co.....	166
Kenyon Transformer Co., Inc.....	4
Lampkin Labs.....	182
McElroy, T. R.....	176
McGraw-Hill Book Co.....	166
Mid-West Radio Mart.....	168-178
Montgomery Ward Co.....	14
National Co., Inc. (E. P. Demarest).....	177
Ohmite Mfg. Co.....	180
Omaha Crystal Labs.....	178
RCA Manufacturing Co.....	6-7-196
Radio Apparatus Mfg. Co.....	172
Radio Amateur Call Book.....	187
Radio Mfg. Engineers.....	3
Radio, Ltd.....	178-179-186
Radio Shack.....	9
Standard Transformer Corp.....	177
Sundt Eng. Co.....	176
Taylor Tubes, Inc.....	15
Teleplex Co.....	170
Thordarson Electric Mfg. Co.....	175
Trimm Radio Mfg. Co.....	170
Uncle Dave's Radio Shack.....	184
Universal Microphone Co., Ltd.....	174
United Transformer Corp.....	194-195
Western Tech. Press.....	184
Wholesale Radio Service Co., Inc.....	181

RADIO

INDEX
for
1936

Issues
205 to 214

A. R. R. L.

(see also *Editorials*)

Board Meeting— <i>Young</i>	July, 59
Director Controversy— <i>W9HCC</i>	Oct., 9
Directors Elected.....	Jan., 29
Directorship Nominations.....	Jan., 29
Investigating Committee Minority Report— <i>Roberts</i>	May, 57
Resolutions of St. Louis Club.....	July, 93
W9HCC, Cairo, and Chicago— <i>Young</i>	Nov., 43

Antennas, Feeders, and Masts

(see also *Ultra High Frequencies*)

Antenna Directivity Fundamentals— <i>Hawkins</i>	Mar., 44
Determining Antenna Resonance— <i>Conklin</i>	Nov., 80
Eastern Version of the "Simple Tower" — <i>Kruse</i>	Mar., 20
Efficient Guy Wires.....	Oct., 51
Getting the Most from the Pi-Type Antenna Coupler— <i>Parmenter</i>	Feb., 69
Getting the Most from the Twisted Pair — <i>Graham</i>	Apr., 18
How Are Your Antenna Halyards?.....	Nov., 25
Making Antenna Lead-in Panels— <i>Kruse</i>	Mar., 26
Multiband Antenna for High Frequencies — <i>Collins and Craft</i>	Feb., 44
Multiband Single-Wire-Fed Antenna— <i>Jones</i>	Apr., 42
New and Practical Directive Antenna — <i>Hawkins</i>	Dec., 32
95-foot Mast at W6FNK.....	Nov., 51
Novel, Directable Antenna— <i>Kruse</i>	July, 16
Simple Tower for Simple Folk— <i>Wibeman</i>	Jan., 47
Simple Two-Band Directive Antenna — <i>Hawkins</i>	Nov., 22
Stormy Weather.....	Dec., 13
28 Mc. Beams— <i>Soub</i>	Nov., 46
Two Halfwaves in Phase Fed by a Twisted Line— <i>Jayenay</i>	Feb., 65
Wire for Collins Multiband Antenna Feeder.....	Apr., 37
W6GRL's Five-Way "V"-Beam.....	May, 49

Book Reviews

Amateur Transmitters (Standard Transformer Corp.).....	Jan., 86
Cathode-Ray Tubes (R.C.A.).....	Jan., 85
Phenomena in High Frequency Systems (Hund).....	Apr., 93
Police Radio Operators' Manual (G.E.).....	Apr., 79
Practical Radio Communication (Nilson and Hornung).....	Jan., 86
Practical Transmitter Design (Pyle).....	Oct., 88
R.C.A. Review.....	July, 92
Guide to Amateur Radio (R.S.G.B.).....	Nov., 89
Radio Amateurs' Handbook (A.R.R.L.).....	Jan., 85
Radio Antenna Handbook.....	July, 55
Radio Engineering Handbook (Henney).....	Apr., 93
Radio Service Business Methods (R.C.A.).....	Oct., 89
Resonance and Alignment (Rider).....	Oct., 88
Short Wave Communication Text (Ladner and Stoner).....	Nov., 89
Television with Cathode Rays (Halloran).....	July, 86
Transmitter and Public Address Manual (United Transformer Corp.).....	July, 86
Treatise on New Alloy "Nipermag".....	Oct., 89
Tube Pamphlet (United Electronics).....	Apr., 92

Calls Heard

Calls Heard, Jan., 76; Feb., 54; Mar., 56; Apr., 60; May, 44; June, 56; July, 43; Oct., 50; Nov., 32; Dec., 50.	
"Heard" and "Worked".....	Nov., 90

Conventions and Hamfests

Conventions and Hamfests, May, 84; June, 95; July, 78; Oct., 89.	
A.M.A. Amateurs' Dinner.....	Apr., 90
Record Hamfest in New York.....	Mar., 79
San Joaquin Hamfest.....	Feb., 87

Diathermy

Diathermy Construction— <i>Gossett</i>	Apr., 13
H.F. Radio Therapy Equipment— <i>Hawkins</i>	Oct., 17

DX

Dx, Feb., 55; Mar., 61; Apr., 62; May, 46; June, 59; July, 45; Oct., 52; Nov., 68; Dec., 52.	
Behavior of Dx Signals.....	Feb., 91
Best Times for 20-Meter Reception.....	Jan., 26
Dx Time Chart for Eastern U.S.A.....	Mar., 61
Great Circle Map Centered on San Francisco.....	Feb., 39
Great Circle Map Centered on Washing- ton, D.C.....	July, 50
QRP Dx Records— <i>VK2NO</i>	May, 86
WAZ, a Dx "Yardstick" (with map).....	Feb., 34
WAZ Honor Roll.....	Dec., 55

Editorials

Anchoring in Hartford.....	June, 7
"Buttinsky".....	Apr., 7
Central's Resolutions.....	Nov., 9
Deferred Dog Fight.....	June, 7
Diathermy Furor.....	May, 7
Directors or Representatives?.....	Nov., 9
Divorce.....	Nov., 86
Enough Has Been Said— <i>VK2N?</i>	Dec., 9
In a Nutshell.....	June, 7
It Must Be So.....	Oct., 9
Knuckling Under.....	Jan., 9
"Lone Wolf".....	June, 85
Merger Editorial.....	Jan., 6
New Tubes.....	Oct., 9
On the Road to Cairo.....	May, 7
Once Again.....	Oct., 9
Perennial QRO-QRP Question— <i>W110B</i>	Dec., 9
Quelling the Bootleggers— <i>W8BBV</i>	Dec., 9
Survey.....	Jan., 9
That 30c Price.....	Feb., 9
They Can No Longer Dodge.....	Apr., 7
Truly Representative League.....	Nov., 86

Emergency and Relief Work

Battery-Operated Emergency Portable.....	Oct., 49
CQ Amateur Stations.....	Jan., 15
Flood Activity.....	May, 59
Hell and High Water— <i>Kruse</i>	May, 28
QRR Moose River.....	June, 50

Federal Communications Commission

A.R.R.L. Withdraws Phone Request.....	Nov., 48
Commercial U.H.F. Allocations.....	Jan., 80
F.C.C. Doings.....	Oct., 57
F.C.C. Looks Ahead.....	May, 39
F.C.C. Rule 411 Amended.....	Feb., 87
40,000 Times \$0.50— <i>QSA5</i>	Mar., 82
QRQ (13 w.p.m.).....	July, 34
Rule 24 Superseded.....	July, 13
F.C.C. to Hear Phone Request.....	July, 21
Unlicensed Transceivers.....	Oct., 64

Five Meters

(see *Ultra High Frequencies*)

Hams Across the Sea

D4BUF— <i>Becker</i>	Nov., 44
FB8AB, ex-FB8C.....	Mar., 60
G6QX.....	Feb., 32